

MATLAB[®]

The Language of Technical Computing

Computation

Visualization

Programming

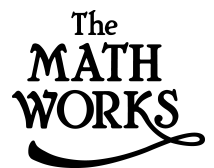

Using MATLAB
Version 6

How to Contact The MathWorks:



www.mathworks.com
comp.soft-sys.matlab

Web
Newsgroup



support@mathworks.com
suggest@mathworks.com
bugs@mathworks.com
doc@mathworks.com
service@mathworks.com
info@mathworks.com

Technical support
Product enhancement suggestions
Bug reports
Documentation error reports
Order status, license renewals, passcodes
Sales, pricing, and general information



508-647-7000

Phone



508-647-7001

Fax



The MathWorks, Inc.
3 Apple Hill Drive
Natick, MA 01760-2098

Mail

For contact information about worldwide offices, see the MathWorks Web site.

Using MATLAB

© COPYRIGHT 1984 - 2001 by The MathWorks, Inc.

The software described in this document is furnished under a license agreement. The software may be used or copied only under the terms of the license agreement. No part of this manual may be photocopied or reproduced in any form without prior written consent from The MathWorks, Inc.

FEDERAL ACQUISITION: This provision applies to all acquisitions of the Program and Documentation by or for the federal government of the United States. By accepting delivery of the Program, the government hereby agrees that this software qualifies as "commercial" computer software within the meaning of FAR Part 12.212, DFARS Part 227.7202-1, DFARS Part 227.7202-3, DFARS Part 252.227-7013, and DFARS Part 252.227-7014. The terms and conditions of The MathWorks, Inc. Software License Agreement shall pertain to the government's use and disclosure of the Program and Documentation, and shall supersede any conflicting contractual terms or conditions. If this license fails to meet the government's minimum needs or is inconsistent in any respect with federal procurement law, the government agrees to return the Program and Documentation, unused, to MathWorks.

MATLAB, Simulink, Stateflow, Handle Graphics, and Real-Time Workshop are registered trademarks, and Target Language Compiler is a trademark of The MathWorks, Inc.

Other product or brand names are trademarks or registered trademarks of their respective holders.

Printing History:	December 1996	First printing	First Printing for MATLAB 5
	June 1997	Second printing	Revised for MATLAB 5.1
	January 1998	Third printing	Revised for MATLAB 5.2
	January 1999	Fourth printing	Revised for MATLAB 5.3 (Release 11)
	November 2000	Fifth printing	Revised for MATLAB 6 (Release 12)
	June 2001	Online only	Revised for MATLAB 6.1 (Release 12.1)

Development Environment

Starting and Quitting MATLAB

1

Starting MATLAB	1-3
Starting MATLAB on Windows Platforms	1-3
Starting MATLAB on UNIX Platforms	1-3
Startup Directory for MATLAB	1-3
Startup Options	1-5
Reducing Startup Time with Toolbox Path Caching	1-10
 Quitting MATLAB	 1-15
Running a Script When Quitting MATLAB	1-15

Using the Desktop

2

Desktop Tools	2-4
Launch Pad	2-5
 Configuring the Desktop	 2-7
Opening and Closing Desktop Tools	2-7
Resizing Windows	2-9
Moving Windows	2-10
Using Predefined Desktop Configurations	2-16
 Common Desktop Features	 2-17
Desktop Toolbar	2-17
Context Menus	2-17

Keyboard Shortcuts and Accelerators	2-18
Selecting Multiple Items	2-19
Using the Clipboard	2-20
Accessing The MathWorks on the Web	2-20
Setting Preferences	2-21
General Preferences for MATLAB	2-23

Running MATLAB Functions

3

The Command Window	3-2
Opening the Command Window	3-2
Running Functions and Entering Variables	3-2
Controlling Input and Output	3-4
Running Programs	3-11
Keeping a Session Log	3-12
Preferences for the Command Window	3-13
Command History	3-17
Viewing Functions in the Command History Window	3-17
Running Functions from the Command History Window	3-18
Copying Functions from the Command History Window	3-19

Getting Help

4

Types of Information	4-3
Using the Help Browser	4-4
Changing the Size of the Help Browser	4-5
Using the Help Navigator	4-7
Using the Product Filter	4-7

Viewing the Contents Listing in the Help Browser	4-9
Finding Documentation Using the Index	4-11
Searching Documentation	4-13
Bookmarking Favorite Pages	4-15
Viewing Documentation in the Display Pane	4-17
Browsing to Other Pages	4-18
Bookmarking Pages	4-18
Revisiting Pages	4-19
Printing Pages	4-19
Finding Terms in Displayed Pages	4-19
Copying Information	4-19
Evaluating a Selection	4-19
Viewing the Page Source (HTML)	4-20
Viewing Web Pages	4-20
Preferences for the Help Browser	4-21
Documentation Location – Specifying the help Directory	4-22
Product Filter – Limiting the Product Documentation	4-23
PDF Reader – Specifying Its Location	4-23
General – Synchronizing the Contents Pane with the Displayed Page	4-23
Help Fonts Preferences – Specifying Font Name, Style, and Size	4-24
Printing Documentation	4-26
Printing a Page from the Help Browser	4-26
Printing the PDF Version of Documentation	4-26
Using Help Functions	4-28
Viewing Function Reference Pages – the doc Function	4-29
Getting Help in the Command Window – the help Function .	4-29
Other Methods for Getting Help	4-31
Product-Specific Help Features	4-31
Running Demos	4-31
Contacting Technical Support	4-32
Providing Feedback	4-32
Getting Version and License Information	4-32

Accessing Documentation for Other Products	4-33
Participating in the Newsgroup for MathWorks Products . . .	4-33

Workspace, Search Path, and File Operations

5

MATLAB Workspace	5-3
Workspace Browser	5-3
Viewing and Editing Workspace Variables	
Using the Array Editor	5-10
 Search Path	 5-14
How the Search Path Works	5-14
Viewing and Setting the Search Path	5-15
 File Operations	 5-20
Current Directory Field	5-20
Current Directory Browser	5-20
Viewing and Making Changes to Directories	5-22
Creating, Renaming, Copying, and	
Removing Directories and Files	5-23
Opening, Running, and Viewing the Content of Files	5-26
Finding and Replacing Content Within Files	5-28
Preferences for the Current Directory Browser	5-30

Importing and Exporting Data

6

Importing Text Data	6-4
Using the Import Wizard with Text Data	6-4
Using Import Functions with Text Data	6-9
Importing Numeric Text Data	6-11
Importing Delimited ASCII Data Files	6-12
Importing Numeric Data with Text Headers	6-13

Importing Mixed Alphanumeric and Numeric Data	6-14
Exporting ASCII Data	6-16
Exporting Delimited ASCII Data Files	6-17
Using the diary Command to Export Data	6-18
Importing Binary Data	6-20
Using the Import Wizard with Binary Data Files	6-20
Using Import Functions with Binary Data	6-22
Exporting Binary Data	6-25
Exporting MATLAB Graphs in AVI Format	6-27
Working with HDF Data	6-29
Overview of MATLAB HDF Support	6-30
MATLAB HDF Function Calling Conventions	6-31
Importing HDF Data into the MATLAB Workspace	6-33
Exporting MATLAB Data in an HDF File	6-41
Including Metadata in an HDF File	6-47
Using the MATLAB HDF Utility API	6-49
Using Low-Level File I/O Functions	6-51
Opening Files	6-52
Reading Binary Data	6-54
Writing Binary Data	6-55
Controlling Position in a File	6-56
Reading Strings Line-By-Line from Text Files	6-58
Reading Formatted ASCII Data	6-59
Writing Formatted Text Files	6-61
Closing a File	6-62

Editing and Debugging M-Files

7

Starting the Editor/Debugger	7-3
Creating a New M-File in the Editor/Debugger	7-4
Opening Existing M-Files in the Editor/Debugger	7-5

Opening the Editor Without Starting MATLAB	7-6
Closing the Editor/Debugger	7-6
Creating and Editing M-Files with the Editor/Debugger ..	7-8
Appearance of an M-File	7-8
Navigating in an M-File	7-11
Saving M-Files	7-15
Running M-Files from the Editor/Debugger	7-15
Printing an M-File	7-16
Closing M-Files	7-16
Debugging M-Files	7-17
Types of Errors	7-17
Finding Errors	7-17
Debugging Example – The Collatz Problem	7-18
Using Debugging Features	7-22
Preferences for the Editor/Debugger	7-35
General Preferences for the Editor/Debugger	7-36
Font & Colors Preferences for the Editor/Debugger	7-37
Display Preferences for the Editor/Debugger	7-38
Keyboard and Indenting Preferences for the Editor/Debugger	7-40
Printing Preferences for the Editor/Debugger	7-42

Improving M-File Performance – the Profiler

8

What Is Profiling?	8-3
Using the Profiler	8-4
The profile Function	8-4
An Example Using the Profiler	8-6
Viewing Profiler Results	8-7
Viewing Profile Reports	8-7
Profile Plot	8-12
Saving Profile Reports	8-13

Interfacing with Source Control Systems

9

Process of Interfacing to an SCS	9-3
Viewing or Selecting the Source Control System	9-4
Function Alternative for Viewing the SCS	9-5
Setting Up the Source Control System	9-6
For SourceSafe Only – Mirroring MATLAB Hierarchy	9-6
For ClearCase on UNIX Only – Set a View and Check Out a Directory	9-6
Checking Files into the Source Control System	9-7
Function Alternative for Checking In Files	9-8
Checking Files Out of the SCS	9-9
Function Alternative for Checking Out Files	9-10
Undoing the Check-Out	9-10

Using Notebook

10

Notebook Basics	10-3
Creating an M-Book	10-3
Entering MATLAB Commands in an M-Book	10-6
Protecting the Integrity of Your Workspace	10-6
Ensuring Data Consistency	10-7
Defining MATLAB Commands as Input Cells	10-8
Defining Cell Groups	10-8
Defining Autoinit Input Cells	10-10
Defining Calc Zones	10-10
Converting an Input Cell to Text	10-11
Evaluating MATLAB Commands	10-12
Evaluating Cell Groups	10-13

Evaluating a Range of Input Cells	10-14
Evaluating a Calc Zone	10-14
Evaluating an Entire M-Book	10-15
Using a Loop to Evaluate Input Cells Repeatedly	10-15
Converting Output Cells to Text	10-16
Deleting Output Cells	10-17
Printing and Formatting an M-Book	10-18
Printing an M-Book	10-18
Modifying Styles in the M-Book Template	10-18
Choosing Loose or Compact Format	10-19
Controlling Numeric Output Format	10-20
Controlling Graphic Output	10-20
Configuring Notebook	10-24
Notebook Command Reference	10-26
Bring MATLAB to Front Command	10-26
Define Autoinit Cell Command	10-26
Define Calc Zone Command	10-27
Define Input Cell Command	10-27
Evaluate Calc Zone Command	10-28
Evaluate Cell Command	10-28
Evaluate Loop Command	10-29
Evaluate M-Book Command	10-30
Group Cells Command	10-30
Hide Cell Markers Command	10-31
Notebook Options Command	10-31
Purge Output Cells Command	10-31
Toggle Graph Output for Cell Command	10-31
Undefine Cells Command	10-32
Ungroup Cells Command	10-32

Mathematics

Matrices and Linear Algebra

11

Function Summary	11-3
Matrices in MATLAB	11-5
Creation	11-5
Addition and Subtraction	11-7
Vector Products and Transpose	11-7
Matrix Multiplication	11-9
The Identity Matrix	11-11
The Kronecker Tensor Product	11-11
Vector and Matrix Norms	11-12
Solving Linear Systems of Equations	11-13
Overview	11-13
Square Systems	11-15
Overdetermined Systems	11-15
Underdetermined Systems	11-18
Inverses and Determinants	11-21
Overview	11-21
Pseudoinverses	11-22
Cholesky, LU, and QR Factorizations	11-25
Cholesky Factorization	11-25
LU Factorization	11-26
QR Factorization	11-28
Matrix Powers and Exponentials	11-32
Eigenvalues	11-35
Singular Value Decomposition	11-39

Polynomials and Interpolation

12

Polynomials	12-3
Polynomial Function Summary	12-3
Representing Polynomials	12-4
Polynomial Roots	12-4
Characteristic Polynomials	12-5
Polynomial Evaluation	12-5
Convolution and Deconvolution	12-6
Polynomial Derivatives	12-6
Polynomial Curve Fitting	12-7
Partial Fraction Expansion	12-8
Interpolation	12-10
Interpolation Function Summary	12-10
One-Dimensional Interpolation	12-11
Two-Dimensional Interpolation	12-13
Comparing Interpolation Methods	12-14
Interpolation and Multidimensional Arrays	12-16
Triangulation and Interpolation of Scattered Data	12-19
Tessellation and Interpolation of Scattered Data in Higher Dimensions	12-27
Selected Bibliography	12-38

Data Analysis and Statistics

13

Column-Oriented Data Sets	13-4
Basic Data Analysis Functions	13-8
Function Summary	13-8
Covariance and Correlation Coefficients	13-11
Finite Differences	13-12

Data Preprocessing	13-14
Missing Values	13-14
Removing Outliers	13-15
Regression and Curve Fitting	13-17
Polynomial Regression	13-18
Linear-in-the-Parameters Regression	13-19
Multiple Regression	13-21
Case Study: Curve Fitting	13-22
Polynomial Fit	13-22
Analyzing Residuals	13-24
Exponential Fit	13-27
Error Bounds	13-30
The Basic Fitting Interface	13-31
Difference Equations and Filtering	13-40
Fourier Analysis and the Fast Fourier Transform (FFT)	13-43
Function Summary	13-43
Introduction	13-44
Magnitude and Phase of Transformed Data	13-49
FFT Length Versus Speed	13-50

Function Functions

14

Function Summary	14-3
Representing Functions in MATLAB	14-4
Plotting Mathematical Functions	14-6
Minimizing Functions and Finding Zeros	14-9
Minimizing Functions of One Variable	14-9
Minimizing Functions of Several Variables	14-10
Setting Minimization Options	14-11

Finding Zeros of Functions	14-12
Tips	14-15
Troubleshooting	14-15
Converting Your Optimization Code to MATLAB Version 5 Syntax	14-16
Numerical Integration (Quadrature)	14-19
Example: Computing the Length of a Curve	14-19
Example: Double Integration	14-20

Differential Equations

15

Initial Value Problems for ODEs and DAEs	15-3
ODE Function Summary	15-3
Introduction to Initial Value ODE Problems	15-6
Initial Value Problem Solvers	15-6
Representing ODE Problems	15-10
Improving ODE Solver Performance	15-16
Examples: Applying the ODE Initial Value Problem Solvers	15-31
Questions and Answers, and Troubleshooting	15-50
Boundary Value Problems for ODEs	15-57
BVP Function Summary	15-57
Introduction to Boundary Value ODE Problems	15-59
Boundary Value Problem Solver	15-60
Representing BVP Problems	15-63
Using Continuation to Make a Good Initial Guess	15-68
Improving BVP Solver Performance	15-75
Partial Differential Equations	15-82
PDE Function Summary	15-82
Introduction to PDE Problems	15-83
MATLAB Partial Differential Equation Solver	15-84
Representing PDE Problems	15-88
Improving PDE Solver Performance	15-93
Example: Electrodynamics Problem	15-94

Selected Bibliography	15-99
------------------------------------	--------------

16

Sparse Matrices

Function Summary	16-3
Introduction	16-6
Sparse Matrix Storage	16-6
General Storage Information	16-7
Creating Sparse Matrices	16-7
Importing Sparse Matrices from Outside MATLAB	16-12
Viewing Sparse Matrices	16-13
Information About Nonzero Elements	16-13
Viewing Sparse Matrices Graphically	16-15
The find Function and Sparse Matrices	16-16
Example: Adjacency Matrices and Graphs	16-17
Introduction to Adjacency Matrices	16-17
Graphing Using Adjacency Matrices	16-18
The Bucky Ball	16-18
An Airflow Model	16-23
Sparse Matrix Operations	16-25
Computational Considerations	16-25
Standard Mathematical Operations	16-25
Permutation and Reordering	16-26
Factorization	16-30
Simultaneous Linear Equations	16-36
Eigenvalues and Singular Values	16-39
Selected Bibliography	16-42

Programming and Data Types

M-File Programming

17

MATLAB Programming: A Quick Start	17-3
Kinds of M-Files	17-3
What's in an M-File?	17-4
Providing Help for Your Programs	17-4
Creating M-Files: Accessing Text Editors	17-5
Scripts	17-7
Simple Script Example	17-7
Functions	17-8
Simple Function Example	17-8
Basic Parts of a Function M-File	17-9
Function Names	17-11
How Functions Work	17-12
Checking the Number of Function Arguments	17-14
Passing Variable Numbers of Arguments	17-16
Local and Global Variables	17-19
Persistent Variables	17-20
Special Values	17-21
Data Types	17-22
Keywords	17-25
Operators	17-26
Arithmetic Operators	17-26
Relational Operators	17-28
Logical Operators	17-29
Operator Precedence	17-32

Flow Control	17-35
if, else, and elseif	17-35
switch	17-37
while	17-39
for	17-40
continue	17-41
break	17-41
try ... catch	17-42
return	17-42
Subfunctions	17-43
Private Functions	17-45
Subscripting and Indexing	17-46
Subscripting	17-46
Advanced Indexing	17-51
String Evaluation	17-54
eval	17-54
feval	17-54
Command/Function Duality	17-56
Empty Matrices	17-57
Operating on an Empty Matrix	17-57
Using Empty Matrices with If or While	17-58
Errors and Warnings	17-59
Error Handling with eval and lasterr	17-59
Displaying Error and Warning Messages	17-60
Dates and Times	17-62
Date Formats	17-62
Current Date and Time	17-67
Obtaining User Input	17-69
Prompting for Keyboard Input	17-69
Pausing During Execution	17-69

Shell Escape Functions	17-70
Optimizing MATLAB Code	17-71
Vectorizing Loops	17-71
Preallocating Arrays	17-73
Making Efficient Use of Memory	17-74

Character Arrays (Strings)

18

Character Arrays	18-5
Creating Character Arrays	18-5
Creating Two-Dimensional Character Arrays	18-6
Converting Characters to Numeric Values	18-7
Cell Arrays of Strings	18-8
Converting to a Cell Array of Strings	18-8
String Comparisons	18-10
Comparing Strings For Equality	18-10
Comparing for Equality Using Operators	18-11
Categorizing Characters Within a String	18-12
Searching and Replacing	18-13
String/Numeric Conversion	18-15
Array/String Conversion	18-16

Multidimensional Arrays

19

Multidimensional Arrays	19-3
Creating Multidimensional Arrays	19-4
Accessing Multidimensional Array Properties	19-8

Indexing	19-9
Reshaping	19-10
Permuting Array Dimensions	19-12
Computing with Multidimensional Arrays	19-14
Operating on Vectors	19-14
Operating Element-by-Element	19-14
Operating on Planes and Matrices	19-15
Organizing Data in Multidimensional Arrays	19-16
Multidimensional Cell Arrays	19-18
Multidimensional Structure Arrays	19-19
Applying Functions to Multidimensional Structure Arrays ..	19-20

Structures and Cell Arrays

20

Structures	20-4
Building Structure Arrays	20-5
Accessing Data in Structure Arrays	20-7
Finding the size of Structure Arrays	20-10
Adding Fields to Structures	20-10
Deleting Fields from Structures	20-10
Applying Functions and Operators	20-10
Writing Functions to Operate on Structures	20-11
Organizing Data in Structure Arrays	20-12
Nesting Structures	20-17
Cell Arrays	20-19
Creating Cell Arrays	20-20
Obtaining Data from Cell Arrays	20-23
Deleting Cells	20-24
Reshaping Cell Arrays	20-25
Replacing Lists of Variables with Cell Arrays	20-25
Applying Functions and Operators	20-27

Organizing Data in Cell Arrays	20-27
Nesting Cell Arrays	20-29
Converting Between Cell and Numeric Arrays	20-30
Cell Arrays of Structures	20-31

Function Handles

21

Benefits of Using Function Handles	21-3
A Simple Function Handle	21-5
Constructing a Function Handle	21-7
Maximum Length of a Function Name	21-7
Evaluating a Function Through Its Handle	21-9
Function Evaluation and Overloading	21-9
Examples of Function Handle Evaluation	21-10
Displaying Function Handle Information	21-13
Fields Returned by the Functions Command	21-14
Types of Function Handles	21-17
Function Handle Operations	21-21
Converting Function Handles to Function Names	21-21
Converting Function Names to Function Handles	21-22
Testing for Data Type	21-23
Testing for Equality	21-23
Saving and Loading Function Handles	21-25
Handling Error Conditions	21-26
Handles to Nonexistent Functions	21-26
Including Path In the Function Handle Constructor	21-26
Evaluating a Nonscalar Function Handle	21-27
Historical Note - Evaluating Function Names	21-28

Classes and Objects: An Overview	22-3
Features of Object-Oriented Programming	22-3
MATLAB Data Class Hierarchy	22-4
Creating Objects	22-4
Invoking Methods on Objects	22-5
Private Methods	22-6
Helper Functions	22-6
Debugging Class Methods	22-6
Setting Up Class Directories	22-7
Data Structure	22-8
Tips for C++ and Java Programmers	22-8
Designing User Classes in MATLAB	22-9
The MATLAB Canonical Class	22-9
The Class Constructor Method	22-10
Examples of Constructor Methods	22-11
Identifying Objects Outside the Class Directory	22-11
The display Method	22-12
Accessing Object Data	22-13
The set and get Methods	22-13
Indexed Reference Using subsref and subsasgn	22-14
Handling Subscripted Reference	22-14
Handling Subscripted Assignment	22-17
Object Indexing Within Methods	22-17
Defining end Indexing for an Object	22-18
Indexing an Object with Another Object	22-19
Converter Methods	22-20
Overloading Operators and Functions	22-21
Overloading Operators	22-21
Overloading Functions	22-23
Example - A Polynomial Class	22-24
Polynom Data Structure	22-24
Polynom Methods	22-24
The Polynom Constructor Method	22-24
Converter Methods for the Polynom Class	22-25

The Polynom display Method	22-28
The Polynom subsref Method	22-28
Overloading Arithmetic Operators for polynom	22-29
Overloading Functions for the Polynom Class	22-31
Listing Class Methods	22-33
Building on Other Classes	22-35
Simple Inheritance	22-35
Multiple Inheritance	22-36
Aggregation	22-37
Example - Assets and Asset Subclasses	22-38
Inheritance Model for the Asset Class	22-38
Asset Class Design	22-39
Other Asset Methods	22-39
The Asset Constructor Method	22-39
The Asset get Method	22-41
The Asset set Method	22-41
The Asset subsref Method	22-42
The Asset subsasgn Method	22-43
The Asset display Method	22-44
The Asset fieldcount Method	22-45
Designing the Stock Class	22-45
The Stock Constructor Method	22-46
The Stock get Method	22-48
The Stock set Method	22-48
The Stock subsref Method	22-49
The Stock subsasgn Method	22-51
The Stock display Method	22-52
Example - The Portfolio Container	22-54
Designing the Portfolio Class	22-54
The Portfolio Constructor Method	22-55
The Portfolio display Method	22-56
The Portfolio pie3 Method	22-57
Creating a Portfolio	22-58
Saving and Loading Objects	22-60
Modifying Objects During Save or Load	22-60

Example - Defining saveobj and loadobj for Portfolio . . .	22-61
Summary of Code Changes	22-61
The saveobj Method	22-62
The loadobj Method	22-62
Changing the Portfolio Constructor	22-63
The Portfolio subsref Method	22-64
Object Precedence	22-65
Specifying Precedence of User-Defined Classes	22-66
How MATLAB Determines Which Method to Call	22-67
Selecting a Method	22-67
Querying Which Method MATLAB Will Call	22-70

External Interfaces and the MATLAB API

A

Finding the Documentation in Online Help	A-2
Reference Documentation	A-4

Development Environment

The MATLAB[®] development environment is a set of tools to help you use MATLAB functions and files. Many of these tools are graphical user interfaces.

Fundamentals

- “Starting and Quitting MATLAB” – How to run MATLAB, and startup and shutdown options.
- “Using the Desktop” – The MATLAB desktop is what you first see when you start MATLAB. It manages the other tools, including the Launch Pad, which is described here.
- “Running MATLAB Functions” – Working in the Command Window and Command History window.
- “Getting Help” – The Help browser, help functions, printed documentation, and other ways to get help.

Additional Development Environment Tools

- “Workspace, Search Path, and File Operations” – Use the Workspace browser, Array Editor, search path tool, Current Directory browser, and equivalent functions.
- “Importing and Exporting Data” – Techniques for bringing data created by other applications into the MATLAB workspace, including the Import Wizard, and packaging MATLAB workspace variables for use by other applications.
- “Editing and Debugging M-Files” – MATLAB’s graphical Editor/Debugger and debugging functions for creating and changing M-files (program files containing MATLAB functions).
- “Improving M-File Performance – the Profiler” – Tool that measures where an M-file is spending its time. Use it help you make speed improvements.
- “Interfacing with Source Control Systems” – Access your source control system from within MATLAB, Simulink, and Stateflow.

-
- **“Using Notebook” – Access MATLAB’s numeric computation and visualization software from within a word processing environment (Microsoft Word).**

Starting and Quitting MATLAB

Starting MATLAB	1-3
Starting MATLAB on Windows Platforms	1-3
Starting MATLAB on UNIX Platforms	1-3
Startup Directory for MATLAB	1-3
Startup Options	1-5
Reducing Startup Time with Toolbox Path Caching	1-10
Quitting MATLAB	1-15
Running a Script When Quitting MATLAB	1-15

These sections describe how to start and quit MATLAB, including options associated with starting and quitting.

- “Starting MATLAB on Windows Platforms” on page 1-3
- “Starting MATLAB on UNIX Platforms” on page 1-3
- “Startup Directory for MATLAB” on page 1-3
- “Startup Options” on page 1-5
- “Reducing Startup Time with Toolbox Path Caching” on page 1-10
- “Quitting MATLAB” on page 1-15
- “Running a Script When Quitting MATLAB” on page 1-15

Starting MATLAB

Instructions for starting MATLAB depend on your platform. For a list of supported platforms, see the system requirements in the *Installation Guide* for your platform or the Products section of the MathWorks Web site, <http://www.mathworks.com>.

Starting MATLAB on Windows Platforms

To start MATLAB on a Microsoft Windows platform, double-click the MATLAB shortcut icon  on your Windows desktop. The shortcut was automatically created by the installer in the installation directory.

If you start MATLAB from a DOS window, type `matlab` at the DOS prompt.

After starting MATLAB, the MATLAB desktop opens – see Chapter 2, “Using the Desktop.”

If you use a virus scanner, your settings may slow down MATLAB startup. For example, if you use McAfee VirusScan, set the options to scan program files only.

Starting MATLAB on UNIX Platforms

To start MATLAB on a UNIX platform, type `matlab` at the operating system prompt.

After starting MATLAB, the MATLAB desktop opens – see Chapter 2, “Using the Desktop.” On UNIX platforms, if the `DISPLAY` environment variable is not set or is invalid, the desktop will not display. On some UNIX platforms, the desktop is not supported – see the *R12 Release Notes* for details.

Startup Directory for MATLAB

The initial current directory in MATLAB depends on your platform and installation. You can start MATLAB in a different directory.

Startup Directory on Windows Platforms

On Windows platforms, when you installed MATLAB, the default startup directory was set to `$matlabroot\work`, where `$matlabroot` is the directory where MATLAB files are installed.

Startup Directory on UNIX Platforms

On UNIX platforms, the initial current directory is the directory you are in on your UNIX file system when you invoke MATLAB.

Changing the Startup Directory

You can start MATLAB in a different directory from the default. The directory you specify will be the current working directory when MATLAB starts. To do so:

- 1 Create a `startup.m` file – see “Using the Startup File for MATLAB, `startup.m`” on page 1-5.
- 2 In the `startup.m` file, include the `cd` function to change to the new directory.
- 3 Put the `startup.m` file in the current startup directory.

For Windows Platforms Only. For Windows platforms, you can follow these steps to change the startup directory:

- 1 Right-click on the MATLAB shortcut icon and select **Properties** from the context menu.

The **Properties** dialog box for `matlab.exe` opens to the **Shortcut** page.

- 2 Enter the new startup directory in the **Start in** field and click **OK**.

The next time you start MATLAB using that shortcut icon, the current directory will be the one you specified in step 2.

You can make multiple shortcuts to start MATLAB, each with its own startup directory, and each startup directory having different startup options.

Startup Options

You can define startup options for MATLAB, which instruct MATLAB to perform certain operations upon startup. There are two ways to specify startup options for MATLAB:

- “Using the Startup File for MATLAB, `startup.m`” on page 1-5
- “Adding Startup Options for Windows Platforms” on page 1-5 or “Adding Startup Options for UNIX Platforms” on page 1-7

Using the Startup File for MATLAB, `startup.m`

At startup, MATLAB automatically executes the master M-file `matlabrc.m` and, if it exists, `startup.m`. The file `matlabrc.m`, which lives in the `local` directory, is reserved for use by The MathWorks, and on multiuser systems, by your system manager.

The file `startup.m` is for you to use to specify startup options. You can modify the default search path, predefine variables in your workspace, or define Handle Graphics® defaults. For example, creating a `startup.m` file with the line

```
addpath \home\me\mytools
cd \home\me\mytools
```

adds `\home\me\mytools` to your default search path and makes that directory the current directory upon startup.

On Windows platforms, place the `startup.m` file in `$matlabroot\toolbox\local`, where `$matlabroot` is the directory in which MATLAB is installed.

On UNIX workstations, place the `startup.m` file in the directory named `matlab` off of your home directory, for example, `~/matlab`.

Adding Startup Options for Windows Platforms

You can add selected startup options (also called command flags) to the target path for your Windows shortcut for MATLAB, or include the option if you start MATLAB from a DOS window. To do so:

- 1 Right-click on the MATLAB shortcut icon  and select **Properties** from the context menu.

The **Properties** dialog box for `matlab.exe` opens to the **Shortcut** panel.

- 2 In the **Target** field, after the target path for `matlab.exe`, add one or more of the allowable startup options listed here.

Option	Description
<code>/automation</code>	Start MATLAB as an automation server, minimized and without the MATLAB splash screen. For more information, see “Client/Server Applications” in the <i>External Interfaces Guide</i> .
<code>/c licensefile</code>	Set <code>LM_LICENSE_FILE</code> to <code>licensefile</code> . It can have the form <code>port@host</code> .
<code>/logfile logfilename</code>	Automatically write output from MATLAB to the specified log file.
<code>/minimize</code>	Start MATLAB minimized and without the MATLAB splash screen.
<code>/nosplash</code>	Start MATLAB without displaying the MATLAB splash screen.
<code>/r M_file</code>	Automatically run the specified M-file immediately after MATLAB starts. This is also referred to as calling MATLAB in batch mode.
<code>/regserver</code>	Modify the Windows registry with the appropriate ActiveX entries for MATLAB. For more information, see “Client/Server Applications” in the <i>External Interfaces Guide</i> .
<code>/unregserver</code>	Modify the Windows registry to remove the ActiveX entries for MATLAB. Use this option to reset the registry. For more information, see “Client/Server Applications” in the <i>External Interfaces Guide</i> .

3 Click **OK**.

Example – Setting the Startup Options to Automatically Run an M-File. To start MATLAB and automatically run the file `results.m`, use this target path for your Windows shortcut.

```
D:\matlabr12\bin\win32\matlab.exe /r results
```

Startup Options If You Run MATLAB from a DOS Window. If you run MATLAB from a DOS window, include the startup options listed in the preceding table after the `matlab` startup function.

For example, to start MATLAB and automatically run the file `results.m`, type

```
matlab /r results
```

Adding Startup Options for UNIX Platforms

Include startup options (also called command flags) after the `matlab` startup function. The startup options for UNIX are listed in the following table

Option	Description
<code>-arch</code>	Run MATLAB assuming architecture <code>arch</code> .
<code>-arch/ext</code>	Run the version of MATLAB with the extension <code>ext</code> if it exists, assuming architecture <code>arch</code> .
<code>-c licensefile</code>	Set <code>LM_LICENSE_FILE</code> to <code>licensefile</code> . It can have the form <code>port@host</code> .
<code>-Ddebugger [options]</code>	Start MATLAB with the specified debugger.
<code>-debug</code>	Turn on MATLAB internal debugging.
<code>-display Xserver</code>	Send X commands to Xserver.
<code>-ext</code>	Run the version of MATLAB with the extension <code>ext</code> , if it exists.
<code>-h</code> or <code>-help</code>	Displays startup options.

Option	Description (Continued)
-mwvisual visualid	Specify the default X visual to use for figure windows.
-n	Print environment variables only.
-nodesktop	<p>Start MATLAB without bringing up the MATLAB desktop. Use this option to run without an X-window, for example, in VT100 mode, or in batch processing mode. Note that if you pipe to MATLAB using the > constructor, the nodesktop option is used automatically.</p> <p>With nodesktop, you can still use most development environment tools by starting them with a function. Specifically use:</p> <ul style="list-style-type: none">• edit to open the Editor/Debugger• helpbrowser to open the Help browser• filebrowser to open the Current Directory browser• workspace to open the Workspace browser• openvar to open the Array Editor <p>You cannot use the LaunchPad and the Command History window in -nodesktop mode.</p> <p>Don't use nodesktop to provide a command line interface, if you prefer that over the desktop tools. Instead, select View -> Desktop Layout -> Command Window Only.</p>

Option	Description (Continued)
-nojvm	Start MATLAB without loading the Java VM. This minimizes memory usage and improves initial startup speed. With <code>nojvm</code> , you cannot use the desktop, nor any of the tools that require Java. The restrictions are the same as those described under UNIX Platform Limitations in the <i>R12 Release Notes</i> .
-nosplash	Start MATLAB without displaying the splash screen during startup.

For example, to start MATLAB without the splash screen, type

```
matlab -nosplash
```

Reducing Startup Time with Toolbox Path Caching

If you run MATLAB from a network server, you can significantly reduce your startup time by using the MATLAB toolbox path cache. The toolbox path cache stores search path information on all toolbox directories under the MATLAB root directory. During startup, MATLAB obtains this information from the cache rather than by reading it from the remote file system.

The toolbox path cache is used only during the startup of your MATLAB session. It is especially useful if you define your MATLAB search path to include many toolbox directories. It takes considerable time to acquire all of this information by scanning directories in the remote file system. Reading it from a pre-generated cache however, is significantly faster. If you have a short toolbox path, there is less benefit to using the cache, but it does still provide a time savings.

If you run MATLAB on a local disk, where your files are not served from a remote system, then the cache may provide no noticeable reduction in startup time. In this case, you may want to leave the toolbox path cache disabled.

Selecting Toolbox Path Cache Preferences

To generate and enable or disable the toolbox path cache, use MATLAB preferences.

- 1 From the MATLAB desktop, select **Preferences** from the **File** menu.

The **Preferences** dialog box appears.

- 2 In the left pane of the dialog box, click **General** to display the **General Preferences** panel in the right pane.

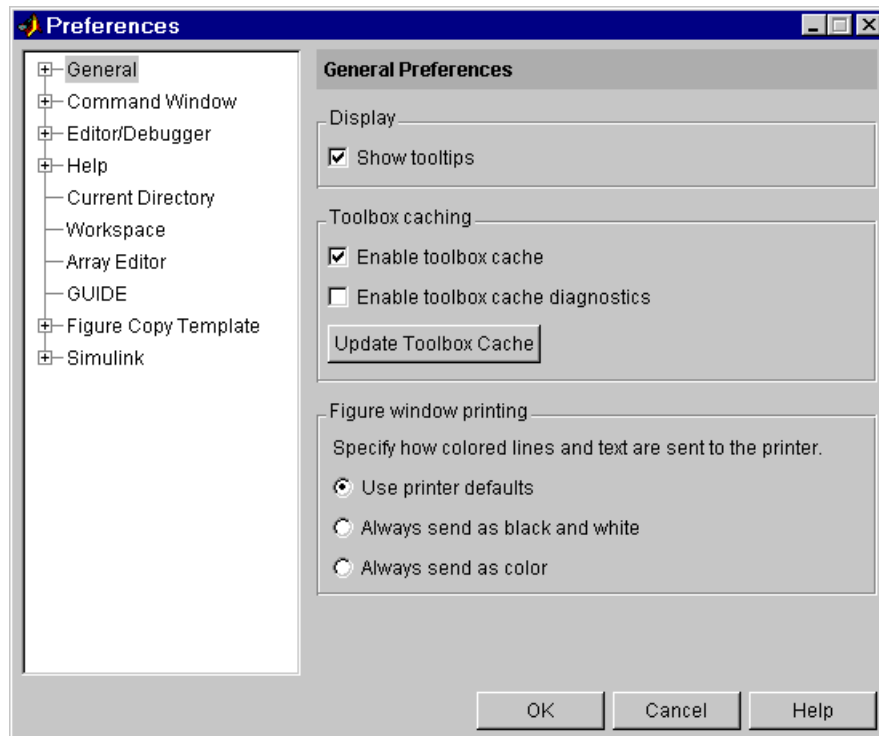

- 3 To use the cache or to regenerate the cache, select **Enable toolbox cache** under **Toolbox caching**.

With **Enable toolbox cache** selected, MATLAB displays summary information during startup, sends notification when it loads the toolbox directories from the cache, and displays a warning if the toolbox path cache cannot be found.

- 4 For additional information, select **Enable toolbox cache diagnostics**.

With **Enable toolbox cache diagnostics** selected, MATLAB displays additional information at startup.

MATLAB also provides warnings whenever a toolbox directory is added to the path from the remote file system at startup rather than from the cache. This occurs if the cache has not been kept up to date with changes in the toolbox directories.

- 5 To generate a new copy of the cache, select **Update Toolbox Cache**. See “Generating the Toolbox Path Cache” on page 1-12 for more information.

To use this, you need write access to the directory that holds the cache file. The button will be grayed out if you don't have write access.

- 6 Select **OK**.

Generating the Toolbox Path Cache

The toolbox path cache is in a MAT-file in the `toolbox/local` directory on the system that serves files for MATLAB. When you first install MATLAB on this system, you or your system administrator needs to generate the cache. (MATLAB does not ship with a prebuilt cache). You also need to regenerate the cache file whenever toolbox directories are added or removed so that the cache does not hold out-dated path information. To do so, select **Update Toolbox Cache** as described in “Selecting Toolbox Path Cache Preferences” on page 1-10.

Function Equivalent. To update the cache, type the following in the Command Window.

```
rehash toolboxcache
```

Enabling Use of the Cache

When MATLAB is first installed, the toolbox path cache feature is disabled. In order to make use of the cache on a distributed file system:

- 1 The system administrator enables caching and generates the initial toolbox path cache on the system that serves files for MATLAB. This is explained in “Generating the Toolbox Path Cache” on page 1-12.

- 2 Each user that intends to use toolbox directory caching enables the cache on their own system.

On a nondistributed system, the system user performs both steps.

To enable toolbox path caching, follow the instructions under “Selecting Toolbox Path Cache Preferences” on page 1-10.

You can disable the use of this feature either on a user-by-user basis or on a global basis. To disable it on a per-user basis, uncheck **Enable toolbox cache** in the **Preferences** dialog box. To disable it on a global basis, remove the file `toolbox_cache.mat` from the `toolbox/local` directory.

Updating the Cache

If you make changes to your toolbox directories, your toolbox path cache file can become out of date. Depending upon the reason for this, you may or may not receive a warning that your cache needs to be updated. This section explains when you need to update your toolbox path cache and how to avoid problems caused by an out-dated cache file.

Updating Cache Following a Product Install or Update. If you install a new toolbox or an update from The MathWorks, it is likely that the information stored in the toolbox path cache no longer accurately reflects your toolbox directories. As part of the installation process, the MATLAB installer marks the cache as being invalid.

When your cache is marked invalid, MATLAB ceases to use cache during startup, loading path information by accessing the directories through the file system instead. MATLAB issues a message at startup to warn you that your toolbox path cache is out-dated and is being ignored. To resume use of the cache, you need to regenerate it using the procedure described in “Generating the Toolbox Path Cache” on page 1-12.

Updating Cache Following Changes to Toolbox Directories. If you make changes to the MATLAB toolbox directories (for example, by adding or deleting files), the path information in the toolbox path cache file becomes out of date. When you start up your next MATLAB session, this out-dated path information will be loaded into memory from the cache. MATLAB does not issue a warning when this occurs.

If you choose to make changes that affect the toolbox path, you must regenerate the cache file using the procedure described in “Generating the Toolbox Path Cache” on page 1-12.

Caution The MathWorks strongly recommends that you do not do development work in the toolbox area when toolbox path caching is enabled. If do you use the toolbox area for this purpose and neglect to regenerate the cache afterwards, MATLAB will use an inaccurate record of your toolbox directories in subsequent MATLAB sessions. As a result, MATLAB will be unable to locate new files that you have added.

Quitting MATLAB

To quit MATLAB at any time, do one of the following:

- Select the close box  in the MATLAB desktop.
- Select **Exit MATLAB** from the desktop **File** menu.
- Type quit at the Command Window prompt.

MATLAB closes immediately, without issuing a warning. If you want to see a warning, use the `finishdlg.m` script as described in the next paragraph.

Running a Script When Quitting MATLAB

When MATLAB quits, it runs the script `finish.m`, if `finish.m` exists in the current directory or anywhere on the MATLAB search path. You create the file `finish.m`. It contains functions to run when MATLAB terminates, such as saving the workspace or displaying a confirmation dialog box. There are two sample files in `$matlabroot\toolbox\local` that you can use as the basis for your own `finish.m` file:

- `finishesav.m` – Includes a save function so the workspace is saved to a MAT-file when MATLAB quits.
- `finishdlg.m` – Displays a confirmation dialog box that allows you to cancel quitting.

Using the Desktop

Desktop Tools	2-4
Launch Pad	2-5
Configuring the Desktop	2-7
Opening and Closing Desktop Tools	2-7
Resizing Windows	2-9
Moving Windows	2-10
Using Predefined Desktop Configurations	2-16
Common Desktop Features	2-17
Desktop Toolbar	2-17
Context Menus	2-17
Keyboard Shortcuts and Accelerators	2-18
Selecting Multiple Items	2-19
Using the Clipboard	2-20
Accessing The MathWorks on the Web	2-20
Setting Preferences	2-21
General Preferences for MATLAB	2-23

When you start MATLAB, the MATLAB desktop appears, containing tools (graphical user interfaces) for managing files, variables, and applications associated with MATLAB. Think of the desktop as your instrument panel for MATLAB. The main things you need to know about the desktop are:

- “Desktop Tools” on page 2-4 – All of the tools managed by the desktop.
- “Configuring the Desktop” on page 2-7 – Arranging the tools in the desktop.
- “Common Desktop Features” on page 2-17 – Features you can use in the tools, such as context menus.

The first time MATLAB starts, the desktop appears as shown in the following illustration, although your Launch Pad may contain different entries.

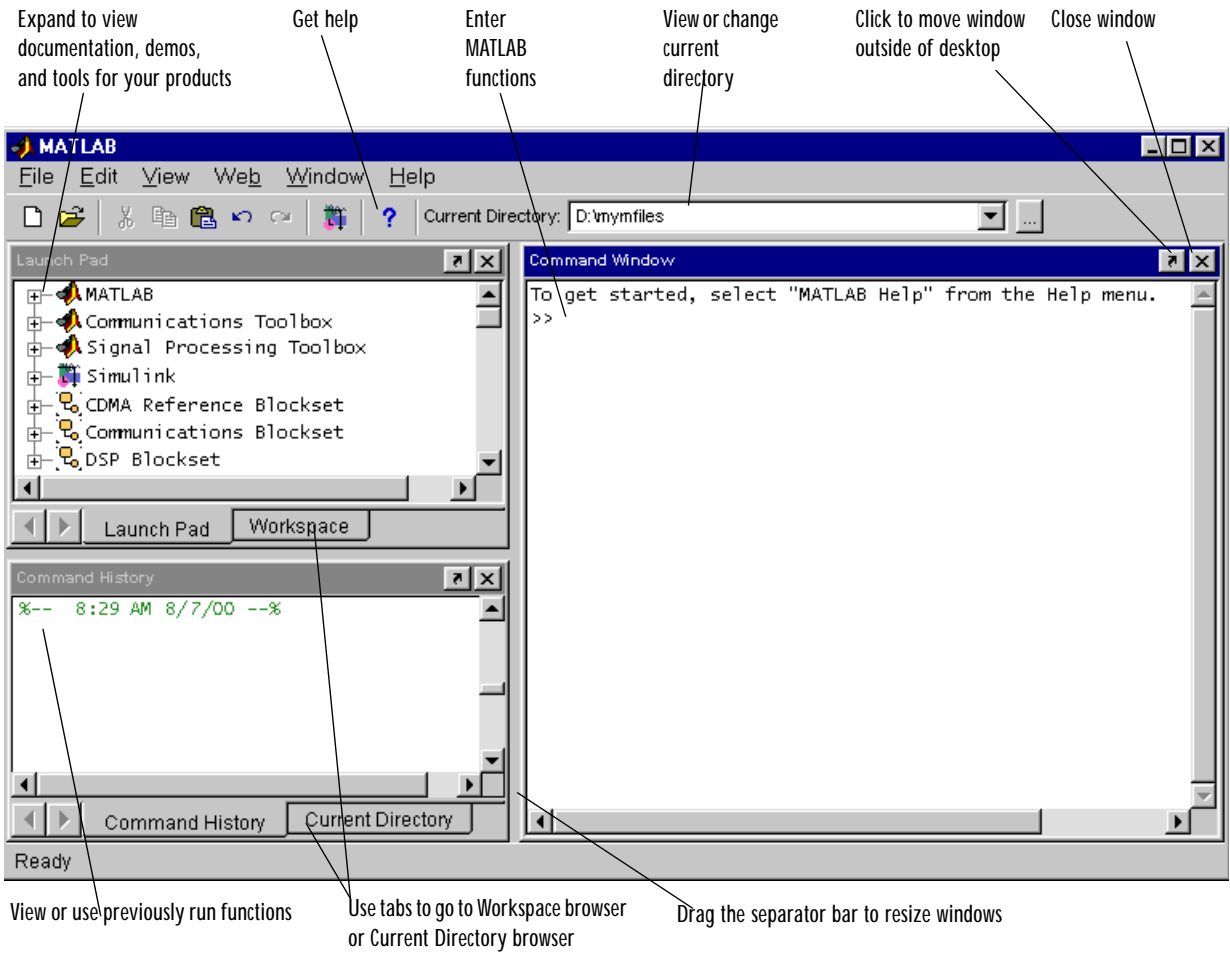

Desktop Tools

The following tools are managed by the MATLAB desktop, although not all of them appear by default when you first start. If you prefer a command line interface, you can use functions to perform most of the features found in the MATLAB desktop tools. Instructions for using these function equivalents are provided with the documentation for each tool.

- **Command Window** – Run MATLAB functions.
- **Command History** – View a log of the functions you entered in the Command Window, copy them, and execute them.
- **Launch Pad** – Run tools and access documentation for all of your MathWorks products.
- **Current Directory Browser** – View MATLAB files and related files, and perform file operations such as open, and find content.
- **Help Browser** – View and search the documentation for the full family of MATLAB products.
- **Workspace Browser** – View and make changes to the contents of the workspace.
- **Array Editor** – View array contents in a table format and edit the values.
- **Editor/Debugger** – Create, edit, and debug M-files (files containing MATLAB functions).

Other MATLAB tools and windows, such as figure windows, are not managed by the desktop.

Launch Pad



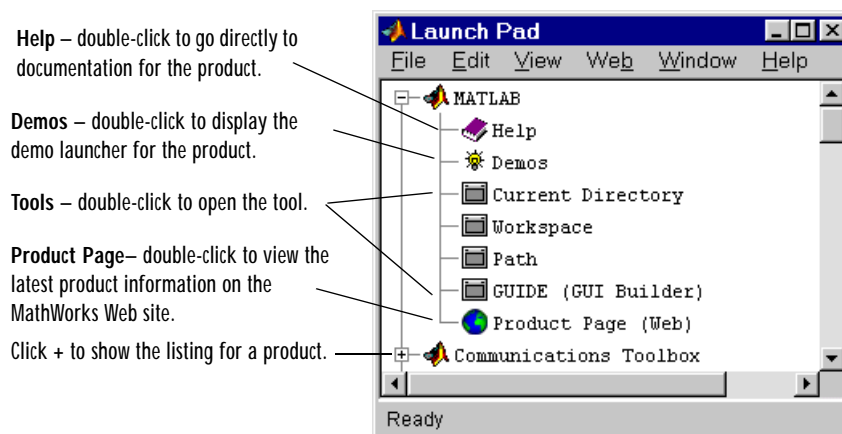

MATLAB's Launch Pad provides easy access to tools, demos, and documentation for all of your MathWorks products. To open it, select **Launch Pad** from the **View** menu in the MATLAB desktop. All the products installed on your system are listed.

Sample of listings in Launch Pad – you'll see listings for all products installed on your system.



To display the listings for a product, click the + to the left of the product. To collapse the listings, click the - to the left of the product.

To open one of the listings, double-click it, or right-click and select **Open** from the context menu. The action depends on the listing you selected, as described in the following table.

Icon	Description of Action When Opened
	Documentation roadmap page for that product opens in the Help browser.
	Demo launcher opens, with the demo for that product selected.
	Selected tool opens.
	Product Page, which contains the latest product information on the MathWorks Web site, opens in your Web browser.

Refreshing the Launch Pad

The Launch Pad includes entries for all products found on the MATLAB search path when the MATLAB session was started. If you change the search path after the start of a session, such as by adding a toolbox directory, the Launch Pad is not automatically updated. Right-click in the Launch Pad and select **Refresh** from the context menu to update the Launch Pad so it reflects all products on the current search path.

Adding Your Own Entries to the Launch Pad

You can add your own entries to the Launch Pad by creating an `info.xml` file. To see an example, select one of the existing entries in the Launch Pad, right-click, and select **Edit Source** from the context menu. The `info.xml` file for that product appears. The line for the tool you selected appears highlighted.

Create a similar `info.xml` file for your own application and put it in a folder that is on the search path. Right-click in the Launch Pad and select **Refresh** from the context menu to update the Launch Pad so it includes your entries.

Configuring the Desktop

You can modify the desktop configuration to best meet your needs. Close tools you don't use, open those you do, resize, and reposition them. Configure the MATLAB desktop by:

- “Opening and Closing Desktop Tools” on page 2-7
- “Resizing Windows” on page 2-9
- “Moving Windows” on page 2-10
- “Using Predefined Desktop Configurations” on page 2-16

When you end a session, MATLAB saves its desktop configuration. The next time you start MATLAB, the desktop is restored the way you left it.

Opening and Closing Desktop Tools

As part of configuring the MATLAB desktop so that it best meets your needs, you can use the following features:

- “Opening Desktop Tools” on page 2-7 – Open only those tools you use.
- “Going to Documents in Desktop Tools” on page 2-8 – Go directly to opened M-files, figures, and more.
- “Closing Desktop Tools” on page 2-9 – Close those tools you don't use.

Opening Desktop Tools

To open a tool from the desktop, select the tool from the **View** menu or double-click it in the list of tools displayed in the Launch Pad for MATLAB. The tool opens in the location it occupied the last time it was open.

There are a few tools controlled by the desktop that you don't open from the **View** menu or Launch Pad:

- Array Editor – Open it by double-clicking a variable in the Workspace Browser.
- Editor/Debugger – Open it by creating a new M-file or opening an existing M-file. For instructions, see “Starting the Editor/Debugger” on page 7-3.

Another way to open a tool is using a function. For example, `helpbrowser` opens the Help browser. These functions are documented with each tool.

The following example shows how the MATLAB desktop might look with the Command Window, Command History, and Help browser open.

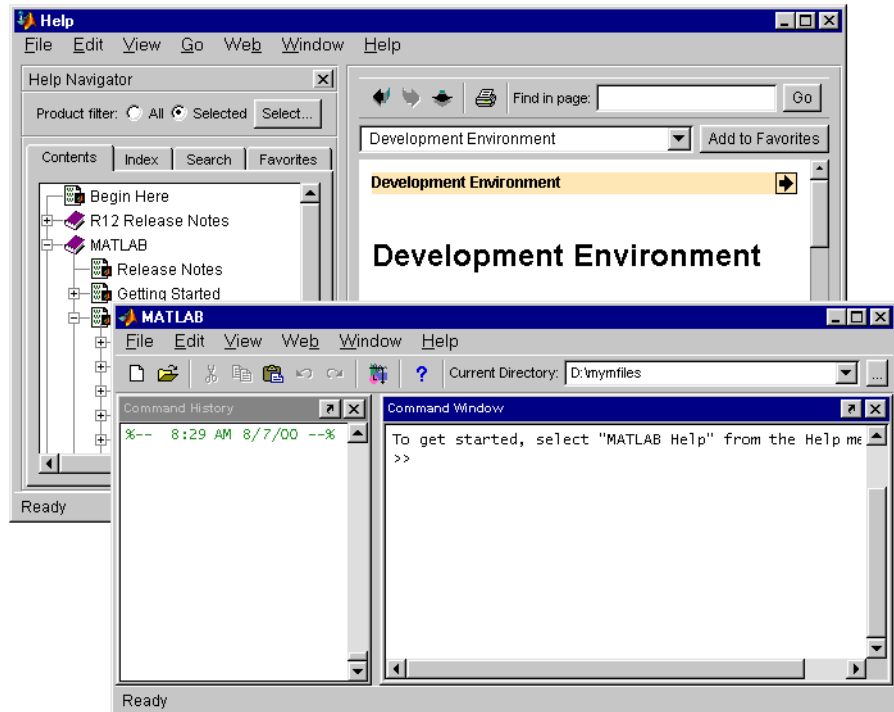

Going to Documents in Desktop Tools

The **Window** menu displays all open Editor/Debugger documents, variables in the Array Editor, and figure windows. Select an entry in the **Window** menu to go directly to that window or tabbed document. Select **Close All** to close all items listed in the **Window** menu.

For example, the **Window** menu in the following illustration shows three documents open in the Array Editor and two documents open in the Editor/

Debugger. Selecting `variance.m`, for example, makes the Editor/Debugger window with the file `variance.m` become the active window.

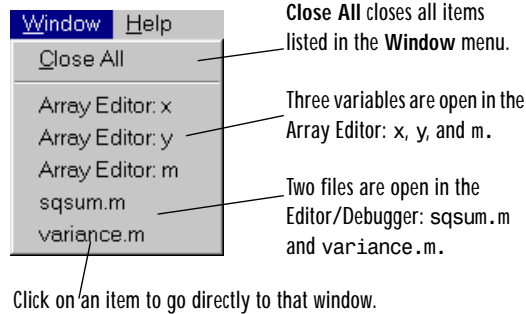

Closing Desktop Tools

To close a desktop tool, do one of the following:

- Select the item in the **View** menu (the item becomes unchecked).
- Click the close box  in the window's title bar.
- Select **Close** from the **File** menu to close the current window.

The window closes.

Resizing Windows

To resize windows in the MATLAB desktop, use the separator bar, which is the bar between two windows:

- 1 Move the cursor onto the separator bar.

The cursor assumes a different shape. On Windows platforms, it is a double-headed arrow . On UNIX, it is an arrow with a bar.

2 Drag the separator bar to change the sizes of the windows.

Drag separator bar to resize windows in the desktop

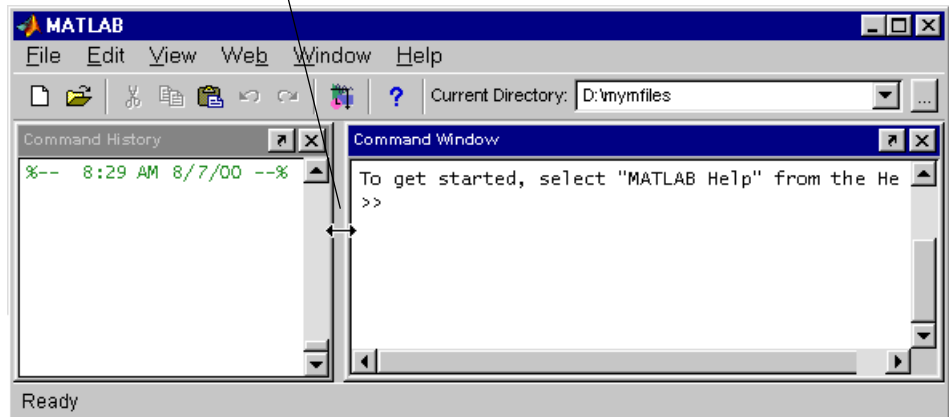

To resize the MATLAB desktop itself or windows for MATLAB tools outside of the desktop, drag any edge or corner of the window.

Moving Windows

There are three basic ways to move MATLAB desktop windows:

- “Moving Windows Within the MATLAB Desktop” on page 2-10
- “Moving Windows Out of the MATLAB Desktop” on page 2-12 and “Moving Windows Into the MATLAB Desktop” on page 2-13
- “Grouping (Tabbing) Windows Together” on page 2-13

Moving Windows Within the MATLAB Desktop

To move a window to another location in the MATLAB desktop:

- 1 Drag the title bar of the window towards where you want the window to be located.

As you drag the window, an outline of it appears. When the outline nears a position where you can dock (keep) it, the outline snaps to that location. The

status bar displays instructions about moving the window while you drag the outline.

In the following example, the Command History window is originally to the left of the Command Window and is being dragged above the Command Window. When the top of Command History window touches the bottom of the toolbar, the outline appears.

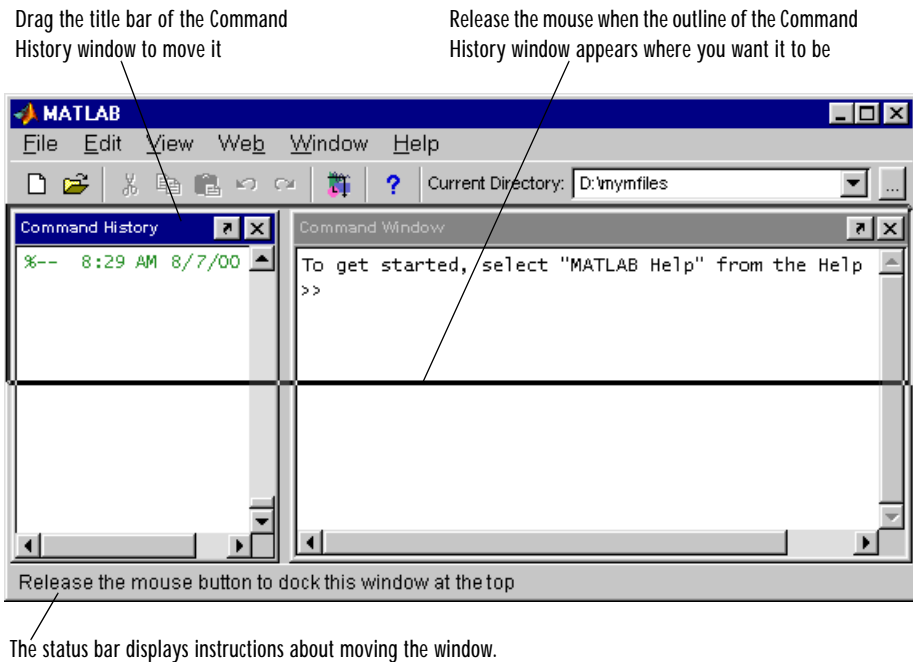

2 Release the mouse to dock the window at the new location.

Other windows in the desktop resize to accommodate the new configuration. The following example shows how the desktop looks after having moved the Command History window above the Command Window.

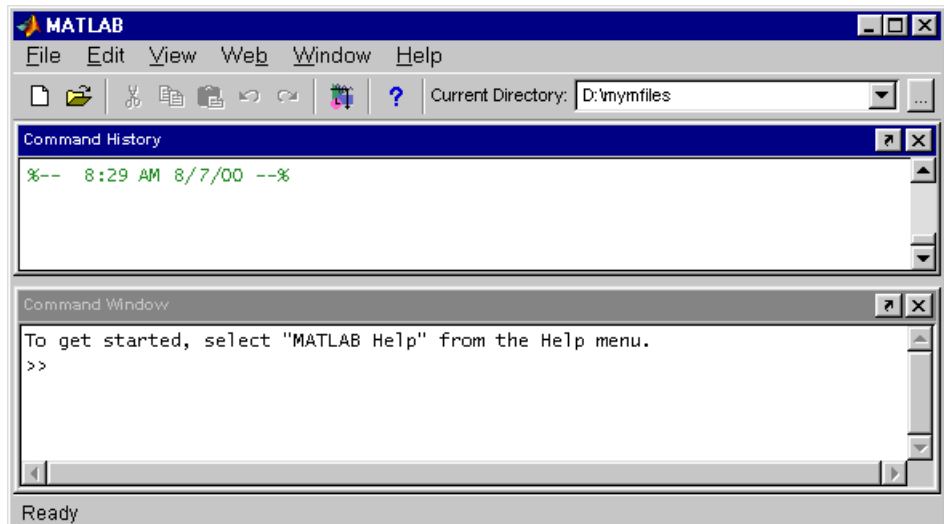

Moving Windows Out of the MATLAB Desktop

To move a window outside of the MATLAB desktop, do one of the following:

- Click the arrow  in the title bar of the window you want to move outside of the desktop.
- Select **Undock** for that tool from the **View** menu; the window must be the currently active window.
- Drag the title bar of the window outside of the desktop. As you drag, an outline of the window appears. When the cursor is outside of the MATLAB desktop, release the mouse.

The window appears outside of the MATLAB desktop. In the following example, the Command History window has been moved outside of the desktop.

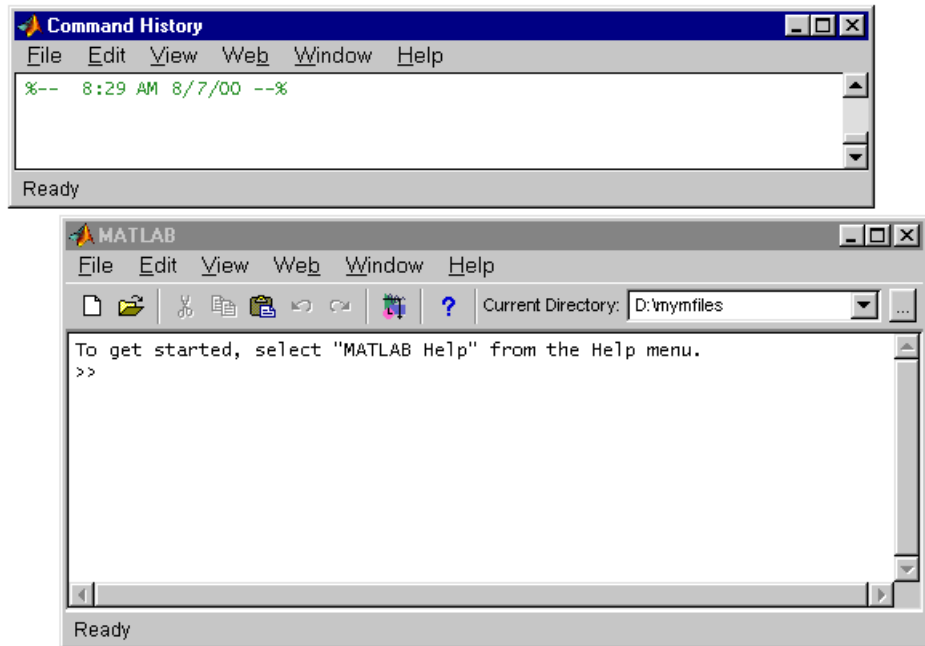

Moving Windows Into the MATLAB Desktop

To move a window that is outside of the MATLAB desktop into the desktop, select **Dock** for that tool from the window's **View** menu.

Grouping (Tabbing) Windows Together

You can group windows so that they occupy the same space in the MATLAB desktop, with access to the individual windows via tabs. These are the main features in working with tabbed windows:

- “Grouping Windows” on page 2-14
- “Viewing Tabbed Windows” on page 2-15
- “Moving Tabbed Windows” on page 2-15
- “Closing Tabbed Windows” on page 2-15

Grouping Windows. To group (also called “to tab”) windows together:

- 1 Drag the title bar of one window in the desktop on top of the title bar of another window in the desktop.

The outline of the window you’re dragging overlays the target window, and the bottom of the outline includes a tab. In the following example, the Command History window is originally to the left of the Command Window and its title bar is being dragged on top of the title bar of the Command Window.

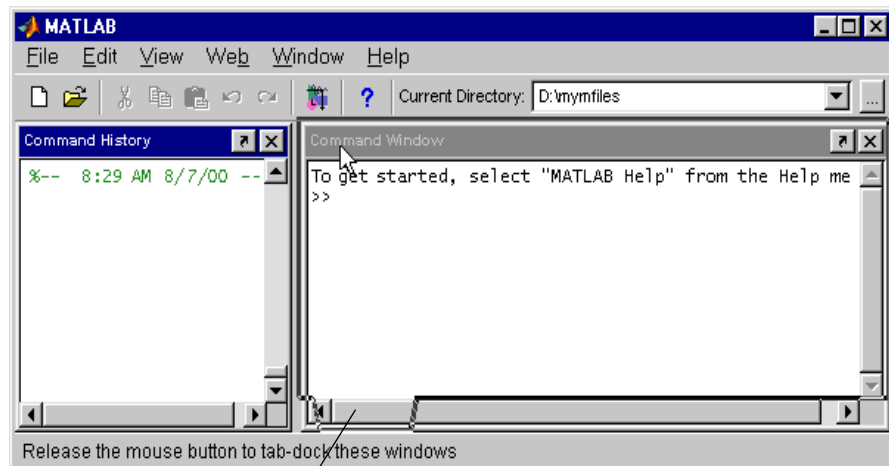

Outline of window, including tab

- 2 Release the mouse.

Both windows occupy the same space and labeled tabs appear at the bottom of that space. In the following example, the Command History and Command Window are tabbed together, with the Command History tab currently selected.

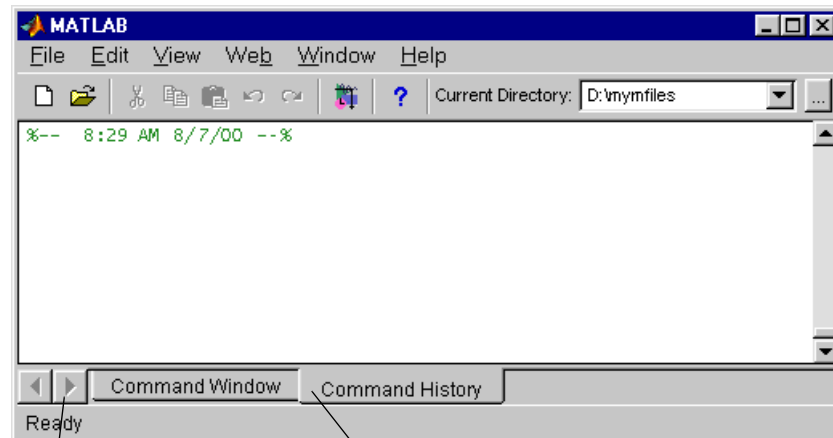

Use arrows to show any tabs that aren't in view. In this example, the arrows are grayed, indicating all tabs are in view.

There are labeled tabs for each tool tabbed together in the window. Click a tab to view that tool.

Viewing Tabbed Windows. To view a tabbed window, click the window's tab. The window moves to the foreground and becomes the currently active window. If there are more tabs in a window than are currently visible, use the arrows to the left of the tabs to see additional tabs.

Moving Tabbed Windows. To move a tabbed window to another location, drag the title bar or the tab to the new location. You can move it inside or outside of the MATLAB desktop.

Closing Tabbed Windows. When you click the close box  for a window that is part of a group of windows tabbed together, that window closes. You cannot close all of the tabbed windows at one time; instead close each window individually.

Using Predefined Desktop Configurations

There are six predefined MATLAB desktop configurations, which you can select from the **View -> Desktop Layout** menu:

- **Default** – Contains the Command Window, the Command History and Current Directory browser tabbed together, and the Launch Pad and Workspace browser tabbed together.
- **Command Window Only** – Contains only the Command Window. This makes MATLAB appear similar to how it looked in previous versions.
- **Simple** – Contains the Command History and Command Window, side-by-side.
- **Short History** – Contains the Current Directory browser and Workspace browser tabbed together above the Command Window and a small Command History.
- **Tall History** – Contains the Command History along the left, and the Current Directory browser and Workspace browser tabbed together above the Command Window.
- **Five Panel** – Contains the Launch Pad above the Command History along the left, the Workspace browser above the Current Directory browser in the center, and the Command Window on the right.

After selecting a predefined configuration, you can move, resize, and open and close windows.

Common Desktop Features

These common features are available for the desktop tools:

- “Desktop Toolbar” on page 2-17
- “Context Menus” on page 2-17
- “Keyboard Shortcuts and Accelerators” on page 2-18
- “Selecting Multiple Items” on page 2-19
- “Using the Clipboard” on page 2-20
- “Accessing The MathWorks on the Web” on page 2-20

Desktop Toolbar

The toolbar in the MATLAB desktop provides easy access to popular operations. Hold the cursor over a button and a tooltip appears describing the item. Note that some of the tools also have a toolbar within their window.

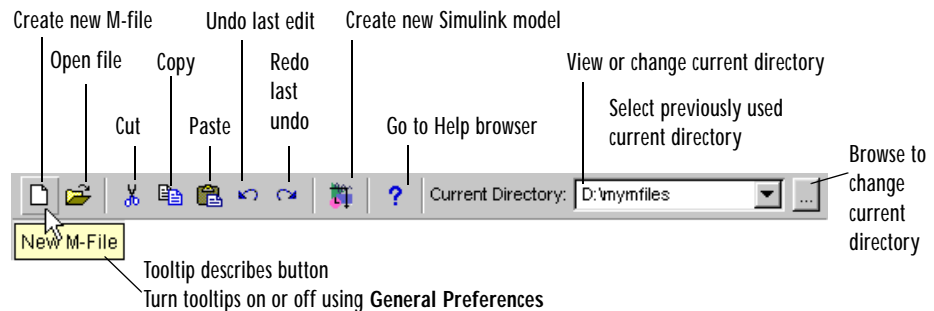

Current Directory Field

The **Current Directory** field in the toolbar shows MATLAB’s current working directory. You can change the current directory using this field and perform other file operations using the Current Directory browser – for instructions, see “File Operations” on page 5-20.

Context Menus

Many of the features of the MATLAB desktop tools are available from context menus, also known as pop-up menus. To access a context menu, right-click on

a selection and the context menu for it appears, presenting the available actions. For example, following is the context menu for a selection in the Command History window.

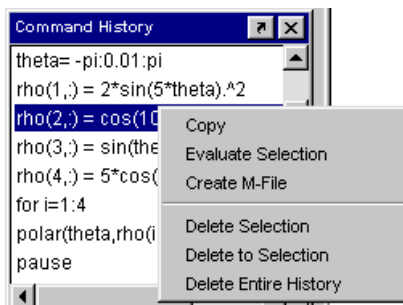

Access context (pop-up) menus by right-clicking on a selection.

Keyboard Shortcuts and Accelerators

You can access many of the menu items using keyboard shortcuts or accelerators for your platform, such as using **Ctrl+X** to perform a **Cut** on Windows platforms, or **Alt+F** to open the **File** menu. Many of the shortcuts and accelerators are listed with the menu item. For example, on Windows platforms, the **Edit** menu shows **Cut Ctrl+X**, and the **File** menu shows the **F** in **File** underlined, which indicates that **Alt+X** opens it. Many standard shortcuts for your platform will work but are not listed with the menu items.

Following are some additional shortcuts that are not listed on menu items.

Keys	Result
Enter	The equivalent of double-clicking, it performs the default action for a selection. For example, pressing Enter while a line in the Command History window is selected runs that line in the Command Window.
Escape	Cancels the current action.
Ctrl+Tab or Ctrl+F6	Moves to the next tab in the desktop, where the tab is for a tool, or for a file in the Editor/Debugger. When used in the Editor/Debugger in tabbed mode outside of the desktop, moves to the next open file.

Keys	Result (Continued)
Ctrl+Shift+Tab	Moves to the previous tab in the desktop, where the tab is for a tool, or for a file in the Editor/Debugger. When used in the Editor/Debugger in tabbed mode outside of the desktop, moves to the previous open file.
Ctrl+Page Up	Moves to the next tab within a group of tools or files tabbed together.
Ctrl+Page Down	Moves to the previous tab within a window.
Alt+F4	Closes desktop or window outside of desktop.
Alt+Space	Displays the system menu.

On the Alpha platform, even though shortcuts are not listed on the menu items, most standard Alpha shortcuts will work.

Selecting Multiple Items

In many of the desktop tools, you can select multiple items and then select an action to perform on all of the selected items. Select multiple items using the standard practices for your platform.

For example, if your platform is Windows, do the following to select multiple items:

- 1 Click on the first item you want to select.
- 2 Hold the **Ctrl** key and then click on the next item you want to select. Repeat this step until you've selected all the items you want.

If you hold the **Shift** key instead of the **Ctrl** key while clicking on an item, you'll select all the items between and including that item and the last item you clicked on.

Now you can perform an action, such as delete, on the selected items.

Using the Clipboard

You can cut and copy a selection from a desktop tool to the clipboard and then paste it from the clipboard into another desktop tool. Use the **Edit** menu, context menus, or standard keyboard shortcuts. For example, you can copy a selection of commands from the Command History window and paste them into the desktop.

The **Paste Special** item in the **Edit** menu opens the selection on the clipboard in the Import Wizard. You can use this to copy data from another application, such as Excel, into MATLAB. For details, see Chapter 6, “Importing and Exporting Data.”

To undo the most recent cut, copy, or paste command, select **Undo** from the **Edit** menu. Use **Redo** to reverse the **Undo**.

You can also copy by dragging a selection. For example, make a selection in the Command History window and drag it to the Command Window, which pastes it there. Edit the lines in the Command Window, if needed and then press the **Enter** key to run the lines from the Command Window.

Accessing The MathWorks on the Web

You can access popular MathWorks Web pages from the MATLAB desktop. Select one of the following items from the **Web** menu – the Web page opens in your default Web browser:

- **The MathWorks Web Site** – Links you to the home page of the MathWorks Web site (<http://www.mathworks.com>).
- **Technical Support Knowledge Base** – Links you to the MathWorks Support page (<http://www.mathworks.com/support>), where you can look for solutions for problems you are having or report new problems.
- **Products** – Links you to the MathWorks Products page (<http://www.mathworks.com/products/>), where you can get information about the full family of products.
- **Membership** – Links you to the MATLAB Access page (<http://www.mathworks.com/mla/index.shtml>) for Access members. If you are not a member, you can join online to help you keep up-to-date on the latest MATLAB developments.

Setting Preferences

Set preferences to modify the default behavior of some aspects of MATLAB such as the font used in the Command Window. Preferences remain persistent across MATLAB sessions. Note that some tools allow you to control these aspects from within the tool without setting a preference – use that method if you only want the change to apply to the current session.

To set preferences:

- 1 Select **Preferences** from the **File** menu.

The **Preferences** dialog box opens. The page it opens to reflects the currently active window.

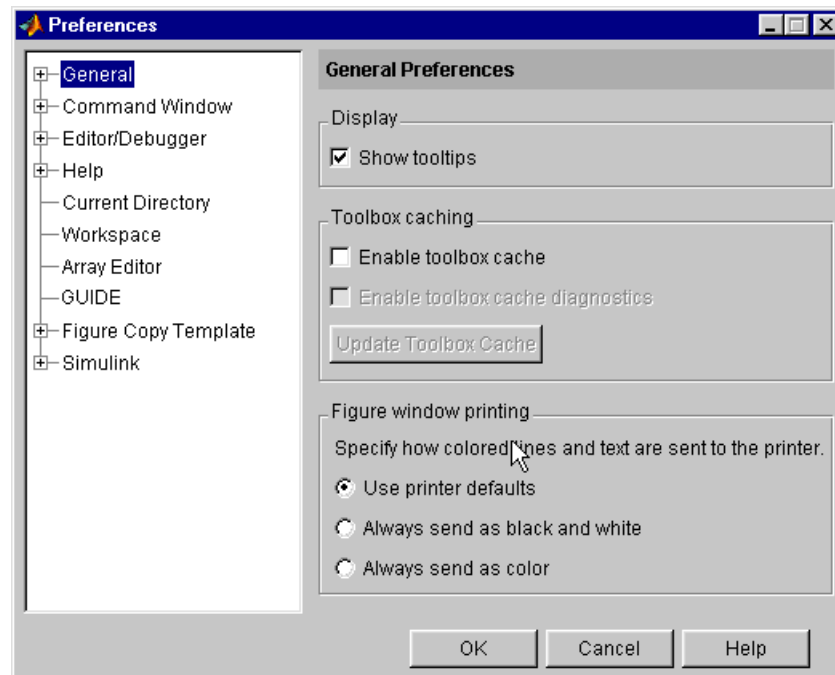

- 2 In the left pane, select the type of preferences you want to specify. In the above example, **General** preferences are selected.

If a + appears to the left of an item, click the + to display more items, and then select the item you want to set preferences for.

The right pane reflects the type of preference you selected.

- 3 In the right pane, specify the preference values and click **OK**.

The preferences take effect immediately.

Type of Preference and Where Described	Items You Can Set Preferences For
“General Preferences for MATLAB” on page 2-23	For desktop display, caching, printing, fonts, colors, and source control system
“Preferences for the Command Window” on page 3-13	Numeric format and display, echo, font, and colors
“Preferences for the Editor/Debugger” on page 7-35	Startup options, font, colors, display, keyboard shortcuts, indenting, and printing
“Printing Documentation” on page 4-26	Documentation location, products, PDF reader location, synchronization, and fonts
“Preferences for the Current Directory Browser” on page 5-30	Number of entries in history and file display options
“Preferences for the Workspace Browser” on page 5-9	Font and confirm deletion of variables
“Preferences for the Array Editor” on page 5-12	Font and numeric format

Type of Preference and Where Described	Items You Can Set Preferences For (Continued)
GUIDE	Display options
Figure Copy Template	Application, text, line, uicontrols, axis, format, background color, and size
Simulink	Display, fonts, and simulation.

The preferences file is `matlab.prf`. Type `prefdir` in the Command Window to see the location of the file. The `matlab.prf` file is loaded when MATLAB starts and overwritten when you close MATLAB.

General Preferences for MATLAB

These preferences apply to all relevant tools in the MATLAB desktop.

Display

To show tooltips when you hold the cursor over a toolbar button, check the **Show tooltips** check box.

Toolbox caching

See “Reducing Startup Time with Toolbox Path Caching” on page 1-10.

Figure window printing

Specify how colored lines and text are sent to the printer. See the Printing documentation for more information.

Font & Colors

Desktop font. Desktop font preferences specify the characteristics of the font used in tools under the control of the MATLAB desktop. The font characteristics are:

- Type, for example, SansSerif
- Style, for example, bold
- Size in points, for example, 12 points

After you make a selection, the **Sample** area shows how the font will look. Lucida Console approximates the fixedsys font available in previous versions of MATLAB.

You can specify a different font for the Command Window, Editor/Debugger, Help browser, Workspace browser, and Array Editor using preferences for those tools.

Syntax highlighting colors. Select the colors to use to highlight syntax. For more information, see “Syntax Highlighting” on page 3-5.

- **Keywords** – Flow control and other functions such as `for` and `if` are colored.
- **Comments** – All lines beginning with a `%` are colored.
- **Strings** – Single quotes and whatever is between them are colored.
- **Unterminated strings** – A single quote without a matching single quote, and whatever follows or precedes the quote are colored.
- **System commands** – Commands such as the `!` (shell escape) are colored.
- **Errors** – The error text is colored.

Click **Restore Default Colors** to return to the default settings. The following example uses the default values for color preferences.

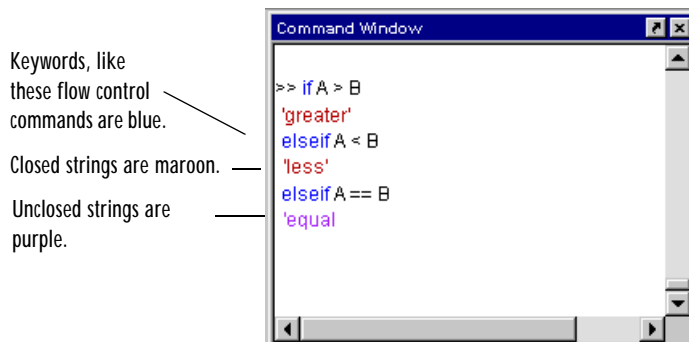

Source Control

Specify the source control system you want to interface MATLAB to. For more information, see Chapter 9, “Interfacing with Source Control Systems.”

Running MATLAB Functions

The Command Window	3-2
Opening the Command Window	3-2
Running Functions and Entering Variables	3-2
Controlling Input and Output	3-4
Running Programs	3-11
Keeping a Session Log	3-12
Preferences for the Command Window	3-13
Command History	3-17
Viewing Functions in the Command History Window	3-17
Running Functions from the Command History Window	3-18
Copying Functions from the Command History Window	3-19

The Command Window

The Command Window is the main way you communicate with MATLAB. It appears in the desktop when you first start MATLAB. Use the Command Window to run MATLAB functions (also referred to as commands) and perform MATLAB operations. The main features of the Command Window are:

- “Opening the Command Window” on page 3-2
- “Running Functions and Entering Variables” on page 3-2
- “Controlling Input and Output” on page 3-4, such as suppressing output and command line editing
- “Running Programs” on page 3-11, including M-files and external programs
- “Keeping a Session Log” on page 3-12
- “Preferences for the Command Window” on page 3-13

Opening the Command Window

To show the Command Window in the MATLAB Desktop, select **Command Window** from the **View** menu – see “Opening and Closing Desktop Tools” on page 2-7 for details.

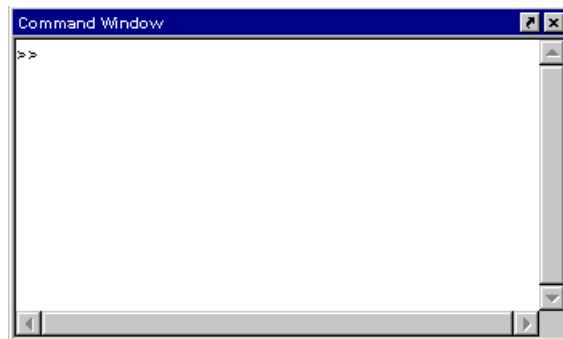

Running Functions and Entering Variables

The prompt (>>) in the Command Window indicates that MATLAB is ready to accept input from you. When you see the >> prompt, you can enter a variable or run a function. For example, to create A, a 3-by-3 matrix, type

```
A = [1 2 3; 4 5 6; 7 8 10]
```

When you press the **Enter** or **Return** key after typing the line, MATLAB responds with

```
A =  
  
     1     2     3  
     4     5     6  
     7     8    10
```

To run a function, type the function including all arguments and press **Return** or **Enter**. MATLAB displays the result. For example, type

```
magic(2)
```

and MATLAB returns

```
ans =  
     1     3  
     4     2
```

If you want to enter multiple lines before running, use **Shift+Enter** or **Shift+Return** after each line until the last. Then press **Enter** or **Return** to run all of the lines.

The `K>>` prompt in the Command Window indicates that MATLAB is in debug mode. For more information, see Chapter 7, “Editing and Debugging M-Files.”

Evaluating a Selection

To run a selection in the Command Window, make the selection, and then right-click and select **Evaluate Selection** from the context menu. You cannot evaluate a selection while MATLAB is busy, for example, running an M-file.

Opening a Selection

To open the M-file for a function, select that function in the Command Window, and then right-click and select **Open Selection** from the context window. The M-file for that function opens in the Editor/Debugger.

Running One Process

You can only run one process at a time. If MATLAB is busy running one function, any commands you issue will be stacked. The next command will run when the previous one finishes. For example, you cannot set breakpoints from

the Editor/Debugger while MATLAB is running a function in the Command Window.

Controlling Input and Output

You can control and interpret input and output in the Command Window in these ways:

- “Case and Space Sensitivity” on page 3-4
- “Entering Multiple Functions in a Line” on page 3-4
- “Entering Long Lines” on page 3-5
- “Syntax Highlighting” on page 3-5
- “Font Used in the Command Window” on page 3-6
- “Command Line Editing” on page 3-6
- “Clearing the Command Window” on page 3-9
- “Suppressing Output” on page 3-9
- “Paging of Output in the Command Window” on page 3-10
- “Controlling the Format and Spacing of Numeric Output” on page 3-10
- “Printing Command Window Contents” on page 3-11

Case and Space Sensitivity

MATLAB is case sensitive. For example, you cannot run the function `Plot` but must instead use `plot`. Similarly, the variable `a` is not the same as the variable `A`. Note that if you use the `help` function, function names are shown in all uppercase, for example, `PLOT`, solely to distinguish them. Do *not* use uppercase when running the functions. Some functions for interfacing to Java actually used mixed case and the M-file help accurately reflects that.

Blank spaces around operators such as `-`, `:`, and `()`, are optional, but they improve readability.

Entering Multiple Functions in a Line

To enter multiple functions on a single line, separate the functions with a comma `(,)` or semicolon `(;)`. Using the semicolon instead of the comma will suppress the output for the command preceding it. For example, put three functions on one line to build a table of logarithms by typing

```
format short; x = (1:10)'; logs = [x log10(x)]
```

and then press **Enter** or **Return** to run the functions in left-to-right order.

Entering Long Lines

If a statement does not fit on one line, use an ellipsis (three periods, ...) to indicate that the statement continues on the next line, press **Enter** or **Return** to advance to the next line, and then continue entering the statement. For example,

```
s = 1 - 1/2 + 1/3 - 1/4 + 1/5 - 1/6 + 1/7 ...
      - 1/8 + 1/9 - 1/10 + 1/11 - 1/12;
```

For items in single quotes, such as strings, put the quotes in each line. For example, entering the following long string

```
headers = ['Author Last Name, Author First Name, ' ...
           'Author Middle Initial']
```

results in

```
headers =
  Author Last Name, Author First Name, Author Middle Initial
```

The maximum number of characters allowed on a single line is 4096.

Syntax Highlighting

Some entries appear in different colors to help you better find elements, such as matching if/else statements:

- Type a string and it is colored purple. When you close the string, it becomes maroon.
- Type a keyword, such as the flow control function for, or a continuation (ellipsis ...), and it is colored blue. Lines you enter between the opening and closing flow control functions are indented.
- Double-click an opening or closing token, a parenthesis (), bracket [], or brace {}. This selects the characters between the token and its mate.
- Type a closing (or opening) token and the matching opening (or closing) token is highlighted briefly.
- Type a mismatched closing (or opening) token and a strikethrough character appears on the token. For example

```
>> CC=C{:+}
```

- Use an arrow key to move over an opening or closing token. That token and its matching closing or opening token briefly appear underlined.
- Type a comment symbol, %, and what follows on the line appears in green. That information is treated by MATLAB as a comment.
- Type a system command, such as the ! (shell escape), and the line appears in gold.
- Errors appear in red.

Default colors are shown here – to change them, use Preferences.

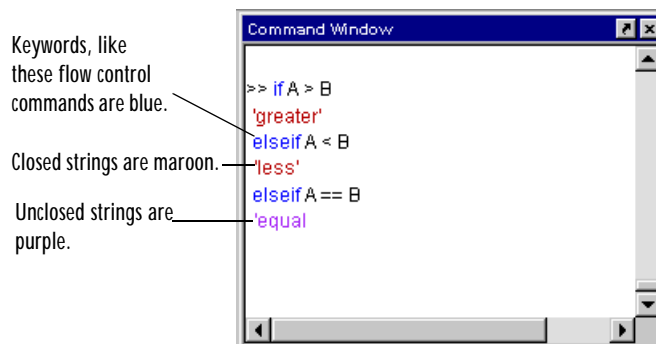

To change the colors used for syntax highlighting, see “Font & Colors Preferences for the Command Window” on page 3-15.

Font Used in the Command Window

You can specify the font type, style, and size used in the Command Window. For instructions, see “Font & Colors Preferences for the Command Window” on page 3-15.

Command Line Editing

These are time-saving features you can use in the Command Window:

- Clipboard features
- Recalling previous lines
- Tab completion

Clipboard Features. Use the **Cut**, **Copy**, **Paste**, **Undo**, and **Redo** features from the **Edit** menu when working in the Command Window. Some of these features are also available in the context menu for the Command Window.

Recalling Previous Lines. Use the arrow, tab, and control keys on your keyboard to recall, edit, and reuse functions you typed earlier. For example, suppose you mistakenly enter

```
rho = (1+ sqrt(5))/2
```

MATLAB responds with

```
Undefined function or variable 'sqrt'.
```

because you misspelled `sqrt`. Instead of retyping the entire line, press the \uparrow key. The previously typed line is redisplayed. Use the left arrow key to move the cursor and add the missing `r`. Repeated use of the up arrow key recalls earlier lines.

The functions you enter are stored in a buffer. You can use *smart recall* to recall a previous function whose first few characters you specify. For example, typing the letters `pl0` and pressing the up arrow key recalls the last function that started with `pl0`, as in the most recent `plot` function. This feature is case sensitive.

Following is the complete list of arrow and control keys you can use in the Command Window. Many of these keys should be familiar to users of the Emacs editor.

Key	Control Key	Operation
↑	Ctrl+P	Recall <i>previous</i> line. See also “Command History” on page 3-17, which is a log of previously used functions, and “Keeping a Session Log” on page 3-12.
↓	Ctrl+N	Recall <i>next</i> line.
←	Ctrl+B	Move <i>back</i> one character.
→	Ctrl+F	Move <i>forward</i> one character.
Ctrl+ →	Ctrl+R	Move <i>right</i> one word.
Ctrl+ ←	Ctrl+L	Move <i>left</i> one word.
Home	Ctrl+A	Move to beginning of line.
End	Ctrl+E	Move to <i>end</i> of line.
Esc	Ctrl+U	Clear line.
Delete	Ctrl+D	Delete character at cursor.
Backspace	Ctrl+H	Delete character before cursor.
	Ctrl+K	Delete (<i>kill</i>) to end of line.
Shift+Home		Highlight to beginning of line.
Shift+End		Highlight to end of line.

Tab Completion. MATLAB completes the name of a function, variable, filename, or handle graphics property if you type the first few letters and then press the **Tab** key. If there is a unique name, the name is automatically completed. For example, if you created a variable `costs_march`, type

```
costs
```

and press **Tab**. MATLAB completes the name, displaying

```
costs_march
```

Press **Return** or **Enter** to run the statement. In this example, MATLAB displays the contents of `costs_march`.

If there is more than one name that starts with the letters you typed, press the **Tab** key again to see a list of the possibilities. For example, type

```
cos
```

and press **Tab**. MATLAB does not display anything, indicating there are multiple names beginning with `cos`. Press **Tab** again and MATLAB displays

```
cos          cosh          costfun
cos_tr       cosint        costs_march
```

The resulting list of possibilities includes the variable name you created, `costs_march`, but also includes functions that begin with `cos`.

Note that the list might include files which are not valid commands, including private functions.

Clearing the Command Window

Select **Clear Command Window** from the **Edit** menu to clear it. This does not clear the workspace, but only clears the view. Afterwards, you still can use the up arrow key to recall previous functions.

Function Equivalent. Use `clc` to clear the Command Window. Similar to `clc`, the home function moves the prompt to the top of the Command Window.

Suppressing Output

If you end a line with a semicolon (;), MATLAB runs the statement but does not display any output when you press the **Enter** or **Return** key. This is particularly useful when you generate large matrices. For example, typing

```
A = magic(100);
```

and then pressing **Enter** or **Return** creates `A` but does not display the resulting matrix.

Paging of Output in the Command Window

If output in the Command Window is lengthy, it might not fit within the screen and will display too quickly for you to see it. Use the `more` function to control the paging of output in the Command Window. By default, `more` is off. When you type `more on`, MATLAB displays only a page (a screen full) of output at a time. After the first screen displays, press one of the following keys.

Key	Action
Enter or Return	To advance to the next line
Space Bar	To advance to the next page
q	To stop displaying the output

Controlling the Format and Spacing of Numeric Output

By default, numeric output in the Command Windows is displayed as 5-digit scaled, fixed-point values. Use the text display preference to change the numeric format of output. The text display format affects only how numbers are shown, not how MATLAB computes or saves them.

Function Equivalent. Use the `format` function to control the output format of the numeric values displayed in the Command Window. The format you specify applies only to the current session. More advanced alternatives are listed in the “See Also” section of the `format` reference page.

Examples of Formats. Here are a few examples of the various formats and the output produced from the following two-element vector `x`, with components of different magnitudes.

```
x = [4/3 1.2345e-6]

format short e
    1.3333e+000    1.2345e-006

format short
    1.3333    0.0000

format +
++
```

For a complete list and description of available formats, see the reference page for `format`. If you want more control over the output format, use the `sprintf` and `fprintf` functions.

Controlling Spacing. Use the text display preference or format function to control spacing in the output. Use

```
format compact
```

to suppress blank lines, allowing you to view more information in the Command Window. To include the blank lines, which can help make output more readable, use

```
format loose
```

Printing Command Window Contents

To print the complete contents of the Command Window, select **Print** from the **File** menu. To print only a selection, first make the selection in the Command Window and then choose **Print Selection** from the **File** menu.

Running Programs

Running M-Files

Run M-files, files that contain code in the MATLAB language, the same way that you would run any other MATLAB function. Type the name of the M-file in the Command Window and press **Enter** or **Return**.

To display each function in the M-file as it executes, use the **Display** preference and check **Echo on**, or use the `echo` function set to on.

Interrupting a Running Program

You can interrupt a running program by pressing **Ctrl+C** or **Ctrl+Break** at any time.

On Windows platforms, you may have to wait until an executing built-in function or MEX-file has finished its operation. On UNIX systems, program execution will terminate immediately.

Running External Programs

The exclamation point character, `!`, is a *shell escape* and indicates that the rest of the input line is a command to the operating system. Use it to invoke utilities or run other programs without quitting from MATLAB. On UNIX, for example,

```
!vi darwin.m
```

invokes the `vi` editor for a file named `darwin.m`. After the program completes or you quit the program, the operating system returns control to MATLAB. See the functions `unix` and `dos` to run external programs that return results and status.

Opening M-Files

To open an M-file, select the file or function name in the Command Window, and then right-click and select **Open Selection** from the context window. The M-file opens in the Editor/Debugger.

Examining Errors

If an error message appears when running an M-file, click on the underlined portion of the error message, or press **Ctrl+Enter**. The offending M-file opens in the Editor, scrolled to the line containing the error.

Keeping a Session Log

The diary Function

The `diary` function creates a copy of your MATLAB session in a disk file, including keyboard input and system responses, but excluding graphics. You can view and edit the resulting text file using any word processor. To create a file on your disk called `sept23.out` that contains all the functions you enter, as well as MATLAB's output, enter

```
diary('sept23.out')
```

To stop recording the session, use

```
diary('off')
```

Other Session Logs

There are two other means of seeing session information:

- The Command History, which contains a log of all functions executed in the current and previous sessions
- For Windows platforms, the `logfile` startup option – see “Adding Startup Options for Windows Platforms” on page 1-5

Preferences for the Command Window

Using preferences, you can specify the format for how numeric values are displayed, set echoing on automatically for each session, specify the font type, style, and size, and set the colors used for syntax highlighting for contents of the Command Window.

To set preferences for the Command Window, select **Preferences** from the **File** menu in the Command Window. The **Preferences** dialog box opens showing **Command Window Preferences**.

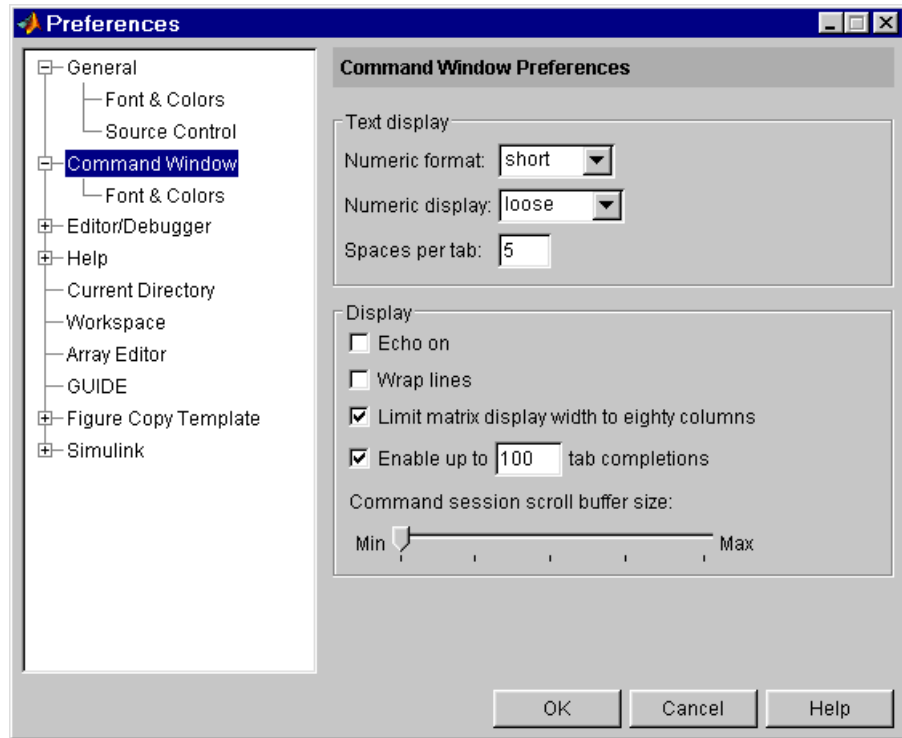

Text Display and Display Preferences for the Command Window

Text display. Specify how output appears in the Command Window:

- **Numeric format** – Output format of numeric values displayed in the Command Window. This affects only how numbers are displayed, not how MATLAB computes or saves them. The format reference page includes the list of available formats.
- **Numeric display** – Spacing of output in the Command Window. To suppress blank lines, use compact. To display blank lines, use loose. For more information, see the reference page for format.
- **Spaces per tab** – Number of spaces assigned to a tab stop when displaying output. The default is 4.

Display. Specify echoing option and buffer size:

- **Echo on** – Check the box if you want commands running in M-files to display in the Command Window during the M-file execution. For more information, see the reference page for echo.
- **Wrap lines** – Input and output in the Command Window uses multiple lines to fit within the current width of the Command Window. Note that the horizontal scroll bar does not appear in this mode because it is not needed.
- **Limit matrix display width to eighty columns** – Check the box if you want MATLAB to display only 80 columns of matrix output, regardless of the width of the Command Window. Uncheck the box if you make the Command Window wider than 80 columns and want matrix output to fill the width of the Command Window. See also the `display` reference page.
- **Enable up to n tab completions** – Check the box if you want to use tab completion when typing functions in the Command Window. Then enter a limit in the edit box. For example, if you enter 10, when you use the tab completion feature, MATLAB displays the list of possible completions if there are 10 or less. If there are more than 10, MATLAB displays a message stating there are more than 10 completions.
Uncheck the box if you do not want to use the tab completion feature. MATLAB moves the cursor to the next tab stop when you press the **Tab** key, rather than completing a function.
- **Command session scroll buffer size** – Set the size of the buffer that maintains a list of previously run commands to be used for command recall. See “Recalling Previous Lines” on page 3-7 for more information.

Font & Colors Preferences for the Command Window

Font. Command Window font preferences specify the characteristics of the font used in the Command Window. Select **Use desktop font** if you want the font in the Command Window to be the same as that specified for **General Font & Colors** preferences.

If you want the Command Window font to be different, select **Use custom font** and specify the font characteristics for the Command Window:

- Type, for example, SansSerif
- Style, for example, bold
- Size in points, for example, 12 points

After you make a selection, the **Sample** area shows how the font will look.

Colors. Specify the colors used in the Command Window:

- **Text color** – The color of nonspecial text; special text uses colors specified for **Syntax highlighting**
- **Background color** – The color of background in the window
- **Syntax highlighting** – The colors to use to highlight syntax. If checked, click **Set Colors** to specify them. For a description of syntax highlighting, see “Syntax Highlighting” on page 3-5.

Command History

The Command History window appears when you first start MATLAB. The Command History window displays a log of the functions most recently run in the Command Window. To show or hide the Command History window, use the **View** menu – see “Opening and Closing Desktop Tools” on page 2-7 for details.

Use the Command History window for:

- “Viewing Functions in the Command History Window” on page 3-17
- “Running Functions from the Command History Window” on page 3-18
- “Copying Functions from the Command History Window” on page 3-19

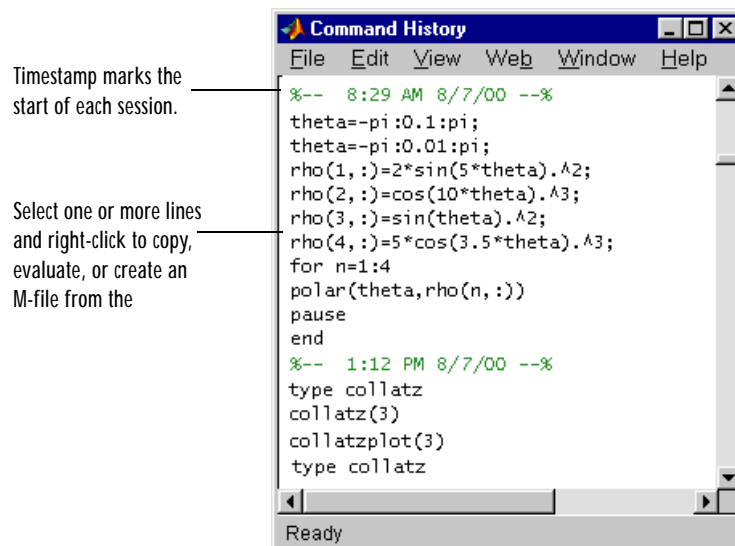

Viewing Functions in the Command History Window

The log in the Command History window includes functions from the current session, as well as from previous sessions. The time and date for each session appear at the top of the history of functions for that session. Use the scroll bar or the up and down arrow keys to move through the Command History window.

The Command History file is `history.m`. Type `prefdir` in the Command Window to see the location of the file. The `history.m` file is loaded when MATLAB starts and overwritten when you close MATLAB.

Deleting Entries in the Command History Window

Delete entries in the Command History window when you feel there are too many and it's inconvenient finding the ones you want. All entries remain until you delete them.

To delete entries in the Command History window, select an entry, or **Shift**+click or **Ctrl**+click to select multiple entries, or use **Ctrl+A** to select all entries. Then right-click and select one of the delete options from the context menu:

- **Delete Selection** – Deletes the selection
- **Delete to Selection** – Deletes all functions previous to (above) the selected function
- **Delete Entire History** – Deletes all functions in the Command History window

Another way to clear the entire history is by selecting **Clear Command History** from the **Edit** menu.

Running Functions from the Command History Window

Double-click on any function entry (entries) in the Command History window to execute that function(s). For example, double-click `edit myfile` to open `myfile.m` in the Editor. You can also run a function entry by right-clicking on it and selecting **Evaluate Selection** from the context menu, or by copying the function entry to the Command Window, as described in the next section.

Copying Functions from the Command History Window

Select a function entry, or **Shift**+click or **Ctrl**+click to select multiple entries, or use **Ctrl+A** to select all entries. Then you can do any of the following.

Action	How to Perform the Action
Run the functions in the command window	Copy the selection to the clipboard by right-clicking and selecting Copy from the context menu. Paste the selection into the Command Window. (Alternatively, drag the selection to the Command Window.) In the Command Window, edit the functions if desired, and press Enter or Return to execute the functions.
Copy the functions to another window	Copy the selection to the clipboard by right-clicking and selecting Copy from the context menu. Paste the selection into an open M-file in the Editor or any application.
Create an M-file from the functions	Right-click the selection and select Create M-File from the context menu. The Editor opens a new M-file that contains the functions you selected from the Command History window.

Getting Help

Types of Information	4-3
Using the Help Browser	4-4
Using the Help Navigator	4-7
Viewing Documentation in the Display Pane	4-17
Preferences for the Help Browser	4-21
Printing Documentation	4-26
Using Help Functions	4-28
Other Methods for Getting Help	4-31

The MathWorks provides online help for all products. Printed versions for some of the online documentation are also provided. The online material sometimes has information not included with the printed material and may be more current than the printed material.

The primary ways to access the online help are:

- “Using the Help Browser” on page 4-4 – Use the Help browser to find and view information about your MathWorks products. It includes a contents listing, global index, and search feature.
- “Using Help Functions” on page 4-28 – Type `help functionname` to get M-file help, which provides a brief description of the function and its syntax in the Command Window. Other help functions are available as well.
- “Other Methods for Getting Help” on page 4-31 – You can use product-specific help features, run demos, contact Technical Support, search documentation for other MathWorks products, view a list of other books, and participate in a MATLAB newsgroup.

In addition to using online help, you can print documentation – see “Printing Documentation” on page 4-26.

Types of Information

The Help browser and help functions provide access to the following types of documentation. Use the type of documentation most suited to your needs.

- **Release Notes** – An overview of new products and features in this release, it also includes upgrade information and any known problems and limitations. Review the Release Notes for all your products when you first start using the new release.
- **Getting Started with ...** – Primarily aimed at novice users, this documentation contains instructions for a product's main features. Review Getting Started documentation before you begin using a product or feature for the first time. Then, to learn more, go to the "Using..." collections or reference pages.
- **Using ... collections** – This material contains overviews and complete instructions for using a product. Consult it after reviewing Getting Started material.
- **Reference Pages** – Every function has a reference page that provides the syntax, description, examples, and other information for that function. It includes links to related functions and additional information. Reference pages are also provided for blocks. Use reference pages to learn about a function or to see its syntax.
- **M-File Help** – Get M-file help in the Command Window to quickly access basic information for a function. It provides a brief description of a function and its syntax. It is called M-file help because the text of the help is a series of comments at the start of the M-file for a function.
- **Product Page** – Available on MathWorks Web site, a product page contains the latest product information, such as system requirements.
- **Online Knowledge Base** – This is the MathWorks Technical Support online knowledge base. It provides solutions to questions posed by users.

Using the Help Browser

Use the Help browser to search and view documentation for MATLAB and your other MathWorks products. The Help browser is a Web browser integrated into the MATLAB desktop that displays HTML documents.

To open the Help browser, click the help button  in the toolbar, or type `helpbrowser` in the Command Window. You can also access the Help browser by selecting **Help** from the **View** menu or by using the **Help** menu in any tool. The Help browser opens.

Tabs in the **Help Navigator** pane provide different ways to find documentation.

View documentation in the display pane.

Use the close box to hide the pane.

Drag the separator bar to adjust the width of the panes.

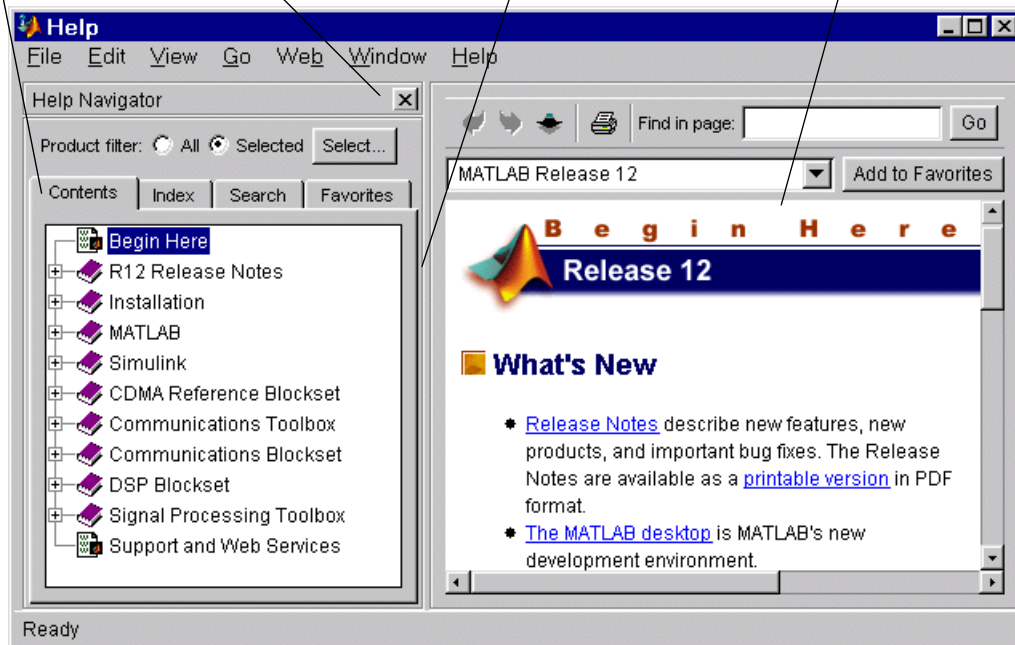



The Help browser consists of two panes:

- The Help Navigator on the left, which you use to find information. It includes a **Product Filter** and **Contents, Index, Search, and Favorites** tabs. For more information, see “Using the Help Navigator” on page 4-7.
- The display pane on the right, which is for viewing documentation.

Changing the Size of the Help Browser

To adjust the relative width of the two panes, drag the separator bar between them. You can also change the font in either of the panes – use “Help Fonts Preferences – Specifying Font Name, Style, and Size” on page 4-24.

Once you’ve found the documentation you want, you can close the **Help Navigator** pane so there is more screen space to view the documentation itself. This is shown in the following figure. To close the **Help Navigator** pane, click the close box  in the pane’s upper right corner or select **View -> Help View Options -> Show Help Navigator** from the menu, which unchecks it. To open the **Help Navigator** pane from the display pane, click the Help Navigator

button  in the upper left corner of the Help browser, or select **View -> Help View Options -> Show Help Navigator**, which checks it.

To show only the display pane, as in this illustration, click the close box in the Help Navigator pane.

Click this button to show the Help Navigator pane.

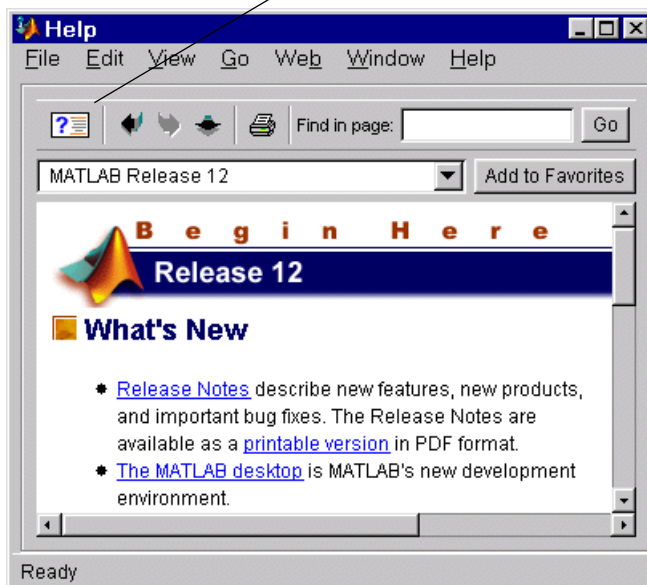

Using the Help Navigator

Use the Help Navigator, the left pane in the Help browser, to find information in the online help. These sections describe the main features:

- “Using the Product Filter” on page 4-7 – Show documentation only for specified products.
- “Viewing the Contents Listing in the Help Browser” on page 4-9 – View an expandable table of contents for documentation.
- “Finding Documentation Using the Index” on page 4-11 – Use keywords to find information.
- “Searching Documentation” on page 4-13 – Find documentation using full-text and other forms of search.
- “Bookmarking Favorite Pages” on page 4-15 – Designate favorite pages for later use.

Using the Product Filter

Use the **Product filter** in the **Help Navigator** to show documentation only for the products you specify.



To show documentation for all MathWorks products installed on your system, select **All**.

To show only a subset of the documentation for MathWorks products installed on your system, set the **Product filter** to **Selected**, which results in the following:

- The **Contents** listing shows only the subset of products you specify.
- The **Index** shows only index terms for the subset of products you specify.
- The **Search** feature only looks through the subset of products you specify.

To specify the subset of products, click the **Select** button. The **Help Product Filter** dialog box opens.

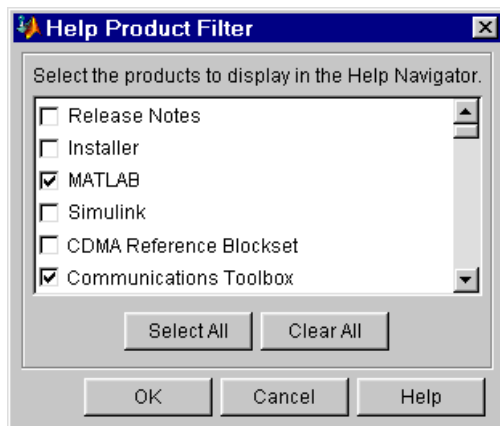

A checkmark appears for all products whose documentation is used in the Help Navigator. Make changes to the selected products and click **OK**. Then, with the **Product filter** set to **Selected**, the Help Navigator only shows documentation for those products you specified.

For example, if you're doing a search and know the information you're seeking is in MATLAB or the Communications Toolbox, in the **Help Product Filter**, click **Clear All** and then select MATLAB and Communications Toolbox. In the Help Navigator, set the **Product filter** to **Selected**. Then, the **Contents** would only show MATLAB and the Communications Toolbox documentation, the **Index** would only show entries for MATLAB and the Communications Toolbox, and the **Search** feature would only look in and show results for MATLAB and the Communications Toolbox.

The product filter settings are remembered for your next MATLAB session.

Viewing the Contents Listing in the Help Browser

To list the titles and table of contents for all product documentation, click the **Contents** tab in the **Help Navigator** pane.

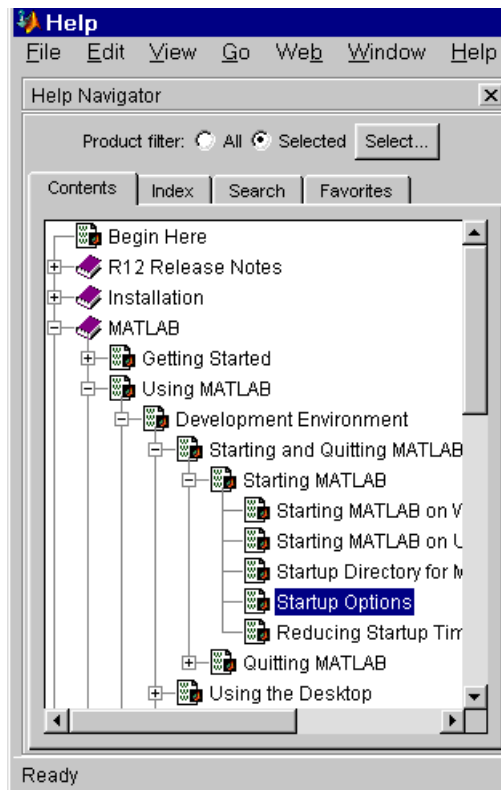

In the **Contents** listing, you can:

- Click the + to the left of an item to expand the listing for the item.
- Click the - to the left of an item, or double-click the item to collapse the listings for that item.
- Select an item to show the first page of that document or section in the display pane.

- Double-click an item to expand the listing for that item and show the first page of that document or section in the display pane.
- Use the down and up arrow keys to move through the list of items.

The **Contents** listing shows documentation for all products installed on your system, or only shows documentation for specified products if you have the **Product filter** set to **Selected**.

Product Roadmap

When you select a product in the **Contents** pane (any entry with a book icon ) , such as MATLAB or the Communications Toolbox, a *roadmap* of the documentation for that product appears in the display pane. The roadmap points to the key documentation for that product and provides links to:

- An index of documentation examples for that product
- The PDF version of the documentation, which is suitable for printing

Product Pages

After expanding the listing for a product in the Contents pane, the last entry is Product Page (Web). This allows you to link to the MathWorks Web site for latest information about that product.

Contents Pane Is Synchronized with Display Pane

By default, the topic highlighted in the **Contents** pane always matches the title of the page appearing in the display pane. The **Contents** listing is said to be synchronized with the displayed document. This feature is useful if you access documentation with a method other than the **Contents** pane, for example, using a link in a page in the display pane. With synchronization, you always know what book and section the displayed page is part of.

You can turn off synchronization. To do so, use preferences – see “General – Synchronizing the Contents Pane with the Displayed Page” on page 4-23.

Note that synchronization only applies to the **Contents** pane. The page shown in the display pane does not necessarily correspond to the selection in the **Search**, **Index**, or **Favorites** tabs.

Finding Documentation Using the Index

To find specific index entries (selected keywords) in the MathWorks documentation for your products, use the **Index** tab in the **Help Navigator** pane.

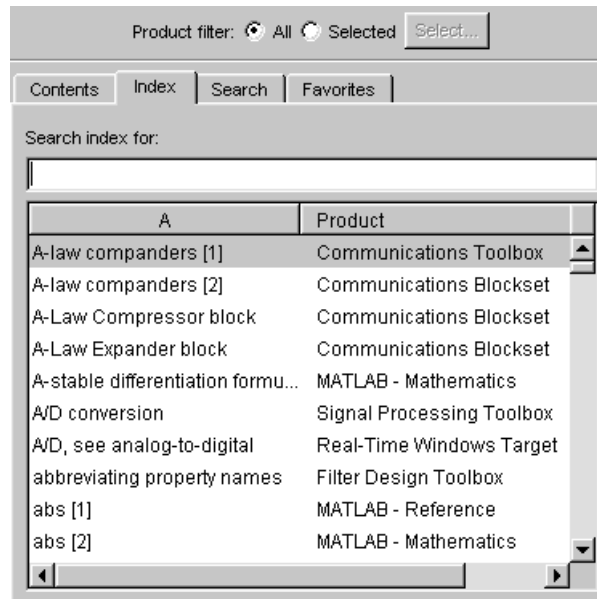

- 1 Set the **Product filter** to **All** or **Selected**.
- 2 Click the **Index** tab.
- 3 Type a word or words in the **Search index for** field. As you type, the index displays matching entries and their subentries (indented). It might take a few moments for the display to appear.

The product and title of the document that includes the matching index entry are listed next to the index entry, which is useful when there are multiple matching index entries. You might have to make the **Help Navigator** pane wider to see the product and document.

- 4 Select the index entry from the list to display that page.

The page appears in the display pane, scrolled to the location where the index entry appears.

- 5 To see more matching entries, scroll through the results.

Tips for Using the Index. If you're not satisfied with the resulting index entries, try one of the following:

- If the **Product filter** is set to **Selected**, change it to **All** to see more results. If it's set to **All**, change it to **Selected** to see fewer results.
- Type a different term or reverse the order of the words you type. For example, if you're looking for `writing M-files`, instead type `M-files` and look for the subentry `creating`.
- Search for the term in the displayed page using the **Find in page** field.
- Make the **Help Navigator** pane wider to see the name of the product and document to which the index entry pertains.
- Try the Search tab – for instructions, see “Searching Documentation” on page 4-13.

Searching Documentation

To look for a specific phrase in the documentation, use the **Search** tab in the **Help Navigator** pane.

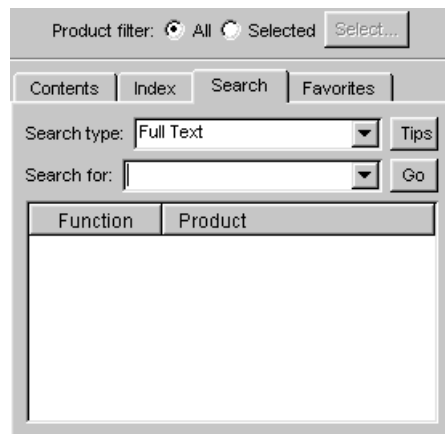

- 1 Set the **Product filter** to **All** or **Selected**.
- 2 Click the **Search** tab.
- 3 Select a **Search type**:
 - **Full Text** searches through all the text in the documentation. This can result in a very large number of results, so it's best to use this after using the **Document Titles** or **Function Name** search types.
 - **Document Titles** searches through the headings in the documentation. This is the best way to start most searches.
 - **Function Name** searches through the function reference pages. This is the equivalent of the doc function.
 - **Online Knowledge Base** connects to the MATLAB Web site and searches through the Technical Support information.

- 4 Type the word or words you want to look for in the **Search for** field, and click **Go** (or press **Enter** or **Return**). The search automatically performs a boolean AND for multiple words. Do not explicitly type AND or similar boolean expressions between words and do not place quotes around terms.

The documents containing the search term are listed, grouped by product. The number of pages containing the search term is displayed in the status bar. For each result, the **Title** and **Section** of the document containing the search phrase are displayed. You might have to make the **Help Navigator** pane wider to see the **Section** name.

- 5 Select an entry from the list of results.

The page containing the search term appears in the display pane and all occurrences of the search term are highlighted in the page. For example, if the search term is font preferences, all occurrences of font and all occurrences of preference are highlighted in the page. To see variants of the term in the page, use the **Find in page** field.

- 6 To see more matching search results, scroll through the list.

Tips for Using Search

Try “Narrowing Search Results” or “More Search Results and Information”.

Narrowing Search Results. If you see many results that are not relevant, try the following.

- Change the **Search type**. For example, for a general topic, use the type **Document Titles**, or to go to the reference page for a function use the **Function name** search type.
- Scroll through the list of results. Results are grouped by product, with a labeled banner separating each group.
- If the **Product filter** is set to **All**, change it to **Selected** to see fewer results.
- Type more than one word in the **Search for** field. For example, type font preferences. The search performs a Boolean AND between the search words. In the example font preferences, it finds all pages that have both the word font and the word preferences, although the page may not necessarily have the exact term “font preferences”. At the top of the results list are any pages that contain both words in the page title.

- Try the **Index**. For operators and special characters, you must use the **Index**, because **Search** won't find them. Index results might return fewer but more relevant entries because the specified term is a keyword, whereas search results include pages with any mention of the specified term.

More Search Results and Information. To see more information about the search results or to get more results, try the following suggestions.

- Search for variants of the term or other terms on the displayed page using the **Find in page** field.
- If the **Product filter** is set to **Selected**, change it to **All** to see more results.
- Make the **Help Navigator** pane wider so you can see the second column, which displays the documentation section that the result appears in.
- To get more search results, try variations of the search word(s) since the search looks for an exact match. For example, search for preferences. If you don't find what you want, try preference. If you are searching for information about an option, try including the - before the option, for example, save -append.

Bookmarking Favorite Pages

Click the **Favorites** tab in the **Help Navigator** to view a list of documents you previously designated as favorites. From the list of favorites you can:

- Select an entry – That document appears in the display pane.
- Remove an entry – Right-click the item in the favorites list and select **Remove** from the context menu, or press the **Delete** key.
- Rename an entry – Right-click the item in the favorites list and select **Rename** from the context menu. Type over the existing name to replace it with a new name.

Adding Favorites

To designate a document page as a favorite, do one of the following:

- While a page is open in the display pane, click the **Add to Favorites** button in the display pane toolbar.
- In the **Contents** listing, right-click an item and select **Add to Favorites** from the context menu.

- In the Help browser index or search results list, right-click an entry and select **Add to Favorites** from the context menu.

The bookmarks file is `matlab_help.hst`. Type `prefdir` in the Command Window to see the location of the file. The `matlab_help.hst` file is loaded when MATLAB starts, and is overwritten when you close MATLAB.

Viewing Documentation in the Display Pane



After finding documentation with the Help Navigator, view the documentation in the display pane. The features available to you while viewing the documentation are:

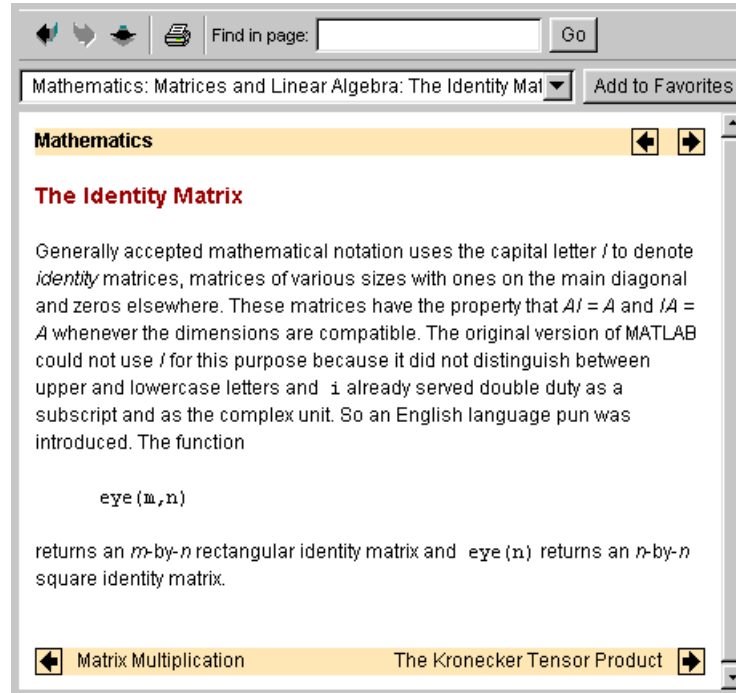

- “Browsing to Other Pages” on page 4-18
- “Bookmarking Pages” on page 4-18
- “Revisiting Pages” on page 4-19
- “Printing Pages” on page 4-19
- “Finding Terms in Displayed Pages” on page 4-19
- “Copying Information” on page 4-19
- “Evaluating a Selection” on page 4-19
- “Viewing the Page Source (HTML)” on page 4-20
- “Viewing Web Pages” on page 4-20

Browsing to Other Pages

Use the arrow buttons in the page and the toolbar to go to other pages.



View the next page in the document by clicking the right arrow  at the top or bottom of the page. View the previous page in the document by clicking the left arrow  at the top or bottom of the page. The arrows at the bottom of the page are labeled with the title of the page they go to.

View the page previously shown by clicking the back button  in the display pane toolbar. After using the back button, view the next page shown by clicking the forward button  in the display pane toolbar. You can also go back or forward by right-clicking on the page and selecting **Back** or **Forward** from the context menu, or by selecting **Back** or **Forward** from the **Go** menu.

Bookmarking Pages

Add the currently displayed page to your list of favorite documents by clicking **Add to Favorites** in the display pane toolbar.

Revisiting Pages

To display a page that you previously viewed in the current MATLAB session, select the page title from the drop-down list in the display pane toolbar.

Printing Pages

For instructions to print the currently displayed page, see “Printing a Page from the Help Browser” on page 4-26.

Finding Terms in Displayed Pages

To find a phrase in the currently displayed page:

- 1 In the **Find in page** field in the display pane toolbar, type the phrase you’re looking for. Then press **Enter** or **Return**, or click **Go**. You can type a partial word, for example, preference to find all occurrences of preference and preferences.

The page scrolls to the location containing the phrase, and highlights it.

- 2 Press **Enter** or **Return** again to find the next occurrence in that page.

See “Searching Documentation” on page 4-13 for instructions to look through all of the documentation instead of just on one page.

Copying Information

To copy information from the display pane, first select the information. Then either right-click and select **Copy** from the context menu, or select **Copy** from the **Edit** menu. You can then paste the information into another tool, such as the Command Window, or into another application, such as a word processor.

Evaluating a Selection

To run code examples that appear in the documentation, select the code in the display pane. Then right-click and select **Evaluate Selection** from the context menu, or select **Evaluate Selection** from the **Go** menu. The functions execute in the Command Window.

Viewing the Page Source (HTML)

To view the HTML source for the currently displayed page, select **View -> Help View Options -> Page Source**. The HTML version of the page appears in the Editor/Debugger. You can modify or copy the HTML source. To view a modified page, use the reload button  in the display pane toolbar, or select **Reload** from the **Go** menu.

Viewing Web Pages

You can use the Help browser to view any Web page, although the Help browser might not support all the features you are used to in your usual Web browser. In the display pane page title field, type the URL and press the **Enter** key. For example, type `www.mathworks.com`. The MathWorks Web page appears in the Help browser.

Preferences for the Help Browser

Using preferences, you can specify the location of your help files, fonts used in the Help browser, and the products whose documentation you want to include in your Help browser.

To set preferences for the Help browser, select **Preferences** from the **File** menu. The **Preferences** dialog box opens showing **Help Preferences**.

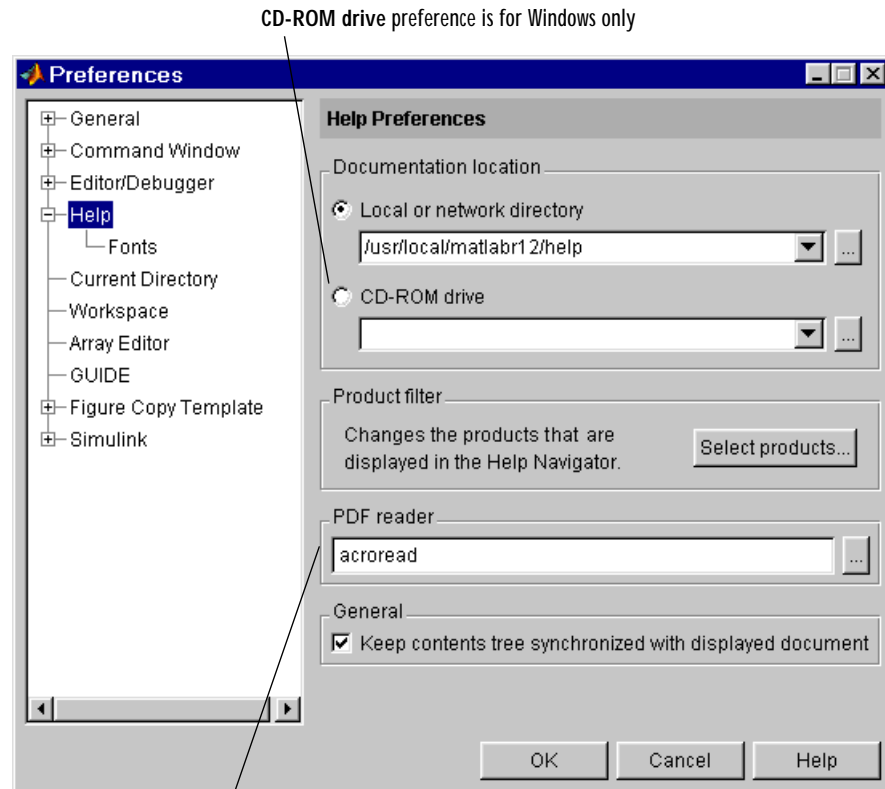

PDF reader preference is for UNIX systems only.

Set the preferences and then click **OK**. Help browser preferences include:

- “Documentation Location – Specifying the help Directory” on page 4-22
- “Product Filter – Limiting the Product Documentation” on page 4-23
- “PDF Reader – Specifying Its Location” on page 4-23
- “General – Synchronizing the Contents Pane with the Displayed Page” on page 4-23
- “Help Fonts Preferences – Specifying Font Name, Style, and Size” on page 4-24

Documentation Location – Specifying the help Directory

Use the **Documentation location** preference to specify where the MATLAB help directory resides for your system. The help directory contains the online help files used by the Help browser:

- If you elected to install the help files when you installed MATLAB, the documentation location should already be set to point to the help files. If the help files location changes or you want to access different help files, change the **Documentation location** for **Local or network directory**. On Windows, use the ... button to browse your file system to select the new location.
- On Windows platforms, if you did not install the help files during MATLAB installation, the Help browser attempts to find the files on the documentation CD. You need to specify the **Documentation location** to be **CD-ROM drive**. Use the ... button to browse your file system to select the drive's location and select the help directory, as shown in the following example.

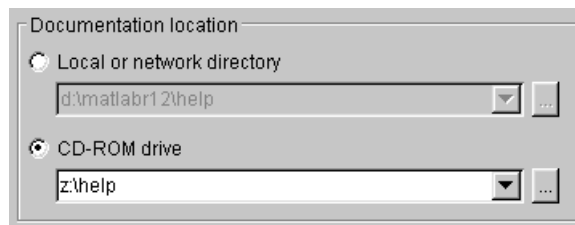

For UNIX platforms that do not support Java GUIs, use the `docopt` function to specify the location of your help directory.

Product Filter – Limiting the Product Documentation

If you have MathWorks products in addition to MATLAB, such as Simulink and toolboxes, you can use the **Product filter** to limit the product documentation used.

In **Help Preferences**, under **Product filter**, click **Select products**. The **Help Product Filter** dialog box opens. Select the products whose documentation you want to appear in the Help Navigator. Then, to use only those products you specified, in the Help browser set the **Product filter** to **Selected**. When you want to use all product documentation, in the Help browser set the **Product filter** to **All**. Note that you can also access the **Help Product Filter** dialog box by clicking the **Select** button in the Help browser.

PDF Reader – Specifying Its Location

If you want to access the PDF versions of the documentation, the Help system needs to know the location of your PDF reader (Adobe Acrobat).

For Windows systems, MATLAB reads the location from the registry so you cannot specify its location in the preferences.

For UNIX systems, when you installed MATLAB, it looked for your system's PDF reader. If found, MATLAB automatically supplied the PDF reader location in the preferences **PDF reader** field. If MATLAB could not locate your PDF reader or if you moved your PDF reader since installation, change the location in the **PDF reader** field. Use the ... button to browse your file system to select the location.

General – Synchronizing the Contents Pane with the Displayed Page

To turn synchronization off, uncheck the item **Keep contents tree synchronized with displayed document**, which is in **Help Preferences, General**. Check the item to turn synchronization on. For more information, see “Contents Pane Is Synchronized with Display Pane” on page 4-10.

Help Fonts Preferences – Specifying Font Name, Style, and Size

You can specify the font name, style, and size used in the Help Navigator, and the font used in the display pane. Expand the Help listing in the left pane of the **Preferences** dialog box and select the **Fonts** item. The **Help Fonts Preferences** panel appears.

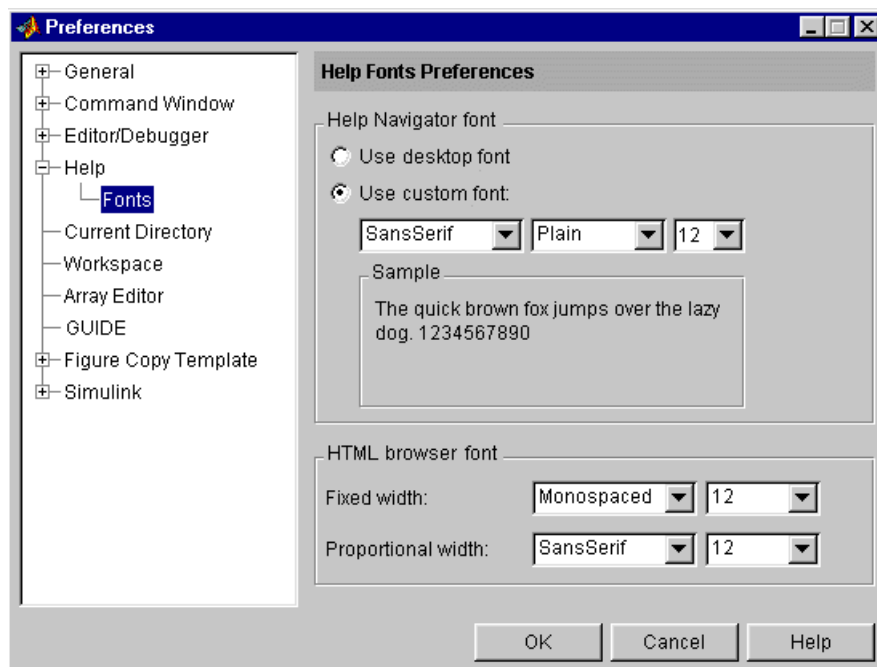

Help Navigator Font

Use **Help Navigator font** preferences to specify the characteristics of the font in the Help Navigator. For example, specify a smaller font size for the Help Navigator to see more information without scrolling.

Select **Use desktop font** if you want the font in the Help Navigator to be the same as that specified under **General - Font & Colors**. If you want the Help

Navigator font to be different, select **Use custom font** and specify the font characteristics for the Help Navigator:

- Type, for example, SansSerif
- Style, for example, bold
- Size in points, for example, 12 points

After you make a selection, the **Sample** area shows how the font will look.

HTML Browser Font

Specify the font type and size used in the display pane for **Fixed width** and **Proportional width** fonts. In MathWorks documentation, most of the text uses proportional-width fonts. A fixed-width font is used for code examples, function names, and system input and output, as shown in this example.

```
t = 0:pi/20:2*pi;  
y = exp(sin(t));  
plotyy(t,y,t,y,'plot','stem')
```

To easily distinguish code, function names, and system input and output from surrounding text in the documentation, specify a different font for fixed width than for proportional width.

Printing Documentation

You can print the current page displayed in the Help browser, or can print a page to an entire book from the PDF version of the documentation. If you wish to purchase printed documentation, see the online store at the MathWorks Web site at <http://www.mathworks.com>.

Printing a Page from the Help Browser

To print the page currently shown in the Help browser, select the print button  from the display pane toolbar, or select **Print** from the **File** menu. The **Print** dialog box appears. Complete the dialog box and press **OK** to print the page.

Printing the PDF Version of Documentation

If you need to print only a few pages and if the quality does not need to be equivalent to pages in a printed book, you can print directly from the MATLAB Help browser – see “Printing Pages” on page 4-19.

If you need to print more than a few pages of documentation, or if you need the pages to appear as if they came from a printed book, print the PDF version of the documentation. PDF documentation is shown and printed using your PDF reader, Adobe Acrobat Reader. The PDF documentation reproduces the look and feel of the printed book, complete with fonts, graphics, formatting, and images. In the PDF document, use links from the table of contents, index, or within the document to go directly to the page of interest.

To print a PDF version of documentation:

- 1 For Windows systems only, insert the documentation CD provided with MATLAB into your CD-ROM drive. PDF files are on the CD and are not installed on your system. (For UNIX systems, the PDF files are installed). If you have problems, check the Help preferences – see “Documentation Location – Specifying the help Directory” on page 4-22.
- 2 In the Help browser, go to the **Contents** tab and select the title (first entry) for a product.

The Roadmap page opens for that product, providing links to key documentation for that product.

- 3** On the bottom of the Roadmap page, listed under **Printing the Documentation**, is a link for printing. Click that link.

If there is only one manual for the product, Acrobat Reader opens, displaying the table of contents and first page of the manual.

If there is more than one item you can print for the product, a page listing the choices appears. Select the item you want to print. Acrobat Reader opens, displaying the documentation.

If you have problems, check the Help preferences – see “PDF Reader – Specifying Its Location” on page 4-23.

- 4** To print the documentation, select **Print** from the **File** menu in Acrobat.

Using Help Functions

There are several help functions that provide different forms of help than the Help browser, or provide alternative ways to access help.

Function	Description
<code>doc</code>	Displays the reference page for the specified function in the Help browser, providing syntax, a description, examples, and links to related functions.
<code>docopt</code>	For UNIX platforms that do not support Java GUIs, use <code>docopt</code> to specify the location of help files.
<code>help</code>	Displays M-file help (a description and syntax) in the Command Window for the specified function.
<code>helpbrowser</code>	Opens the Help browser, the MATLAB interface for accessing documentation.
<code>helpdesk</code>	Opens the Help browser. In previous releases, <code>helpdesk</code> displayed the Help Desk, which was the precursor to the Help browser. In a future release, the <code>helpdesk</code> function will be phased out.
<code>helpwin</code>	Displays in the Help browser a list of all functions, providing access to M-file help for the functions.
<code>lookfor</code>	Displays in the Command Window a list and brief description for all functions whose brief description includes the specified keyword.
<code>web</code>	Opens the specified URL in the specified Web browser, with the default being the MATLAB Help browser. You can use the <code>web</code> function in your own M-files to display documentation.

Viewing Function Reference Pages – the doc Function

To view the reference page for a function in the Help browser, use `doc`. This is like using the Help browser search feature, with **Search type** set to **Function name**. For example, type

```
doc format
```

to view the reference page for the `format` function.

Overloaded Functions

When a function name is used in multiple products, it is said to be an overloaded function. The `doc` function displays the reference page for the first function with that name found on the path, and lists the overloaded functions in the Command Window. To get help for an overloaded function, specify the name of the directory containing the function you want the reference page for, followed by the function name. For example, to display the reference page for the `set` function in the Database Toolbox, type

```
doc database/set
```

Getting Help in the Command Window – the help Function

To quickly view a brief description and syntax for a function in the Command Window, use the `help` function. For example, typing

```
help bar
```

displays a description and syntax for the `bar` function in the Command Window. This is called the M-file help. For other arguments you can supply, see the reference page for `help`.

If you need more information than the `help` function provides, use the `doc` function, which displays the reference page in the Help browser. It can include color, images, links, and more extensive examples than the M-file help. For example, typing

```
doc bar
```

displays the reference page for the `bar` function in the Help browser.

Note M-file help displayed in the Command Window uses all uppercase characters for the function and variable names to make them stand out from the rest of the text. When typing function names, however, use lowercase characters. Some functions for interfacing to Java do use mixed case; the M-file help accurately reflects that and you should use mixed case when typing them.

Overloaded Functions

When a function name is used in multiple products, it is said to be an overloaded function. The `help` function displays M-file help for the first function with that name found on the path, and lists the overloaded functions at the end. To get help for an overloaded function, specify the name of the directory containing the function you want help for, followed by the function name. For example, to get help for the `set` function in the Database Toolbox, type

```
help database/set
```

Creating M-File Help for Your Own M-Files

You can create M-file help for your own M-files and access it using the `help` command. See the `help` reference page for details.

Other Methods for Getting Help

In addition to using the Help browser and help functions, these are the other ways to get help for MathWorks products:

- “Product-Specific Help Features” on page 4-31
- “Running Demos” on page 4-31
- “Contacting Technical Support” on page 4-32
- “Providing Feedback” on page 4-32
- “Getting Version and License Information” on page 4-32
- “Accessing Documentation for Other Products” on page 4-33
- “Participating in the Newsgroup for MathWorks Products” on page 4-33

Product-Specific Help Features

In addition to the Help browser and help functions, some products and tools allow other methods for getting help. You will encounter some methods in the course of using a product, such as entries in the **Help** menu, **Help** buttons in dialog boxes, and selecting **Help** from a context menu. These methods all display context-sensitive help in the Help browser. Other methods for getting help, such as pressing the **F1** key, are described in the documentation for the product or tool that uses the method.

Running Demos

Many products include demos that show the key features. It’s often helpful to run demos when you first use a product. To see a list of the demos available for a product, use the Launch Pad, and then select a demo to run it. Some products also provide access to their demos on the **Help** menu.

Contacting Technical Support

If your computer is connected to the Internet, you can contact MathWorks Technical Support for help with product problems.

- Find specific Technical Support information using the Help browser **Search** feature, with the **Search type** set to **Online Knowledge Base**. The knowledge base provides the most up-to-date solutions for questions users pose.
- Select **Technical Support Knowledge Base** from the **Web** menu to go the Technical Support Web page. The page displays in your system's default Web browser. You can find out about other types of information including third-party books, ask questions, make suggestions, and report possible bugs.

Providing Feedback

To report any problems or provide any comments or suggestions to The MathWorks about the documentation and help features, send e-mail to `doc@mathworks.com`.

Alternatively, you can fill out a form on the Web. To access the form, go to the **Contents** pane in the Help browser. Open the last entry, **Support and Web Services**, and select **Feedback on Help**.

To suggest enhancements for or provide feedback about MathWorks products, send e-mail to `suggest@mathworks.com`. To report problems, send e-mail to `bugs@mathworks.com` or contact Technical Support.

Getting Version and License Information

If you need the product version or license information, select **About** from the **Help** menu for that product. The version is displayed in an **About** dialog box. Click **Show License** in the dialog box to view license information. Note that the information displayed does not cover your specific license agreement. If the product does not have a **Help** menu, use the `ver` function. To see the license number for MATLAB, type `license` in the Command Window. See also the `ver` and `version` functions.

Accessing Documentation for Other Products

The Help browser provides access to documentation for all products installed on your system. If you want to look through documentation for MathWorks products you don't have, you can:

- View any product's online documentation at the MathWorks Web site, <http://www.mathworks.com>. Use Access login. If you are not an Access member, select **Membership** from the **Web** menu and follow the instructions to join.
- You can access documentation for all products from the documentation CD provided with MATLAB. It contains PDF files for all products. Use preferences for the Help browser to set the documentation location to the CD-ROM drive and use the product filter to specify those products whose documentation you want to see. For instructions, see "Preferences for the Help Browser" on page 4-21.

Participating in the Newsgroup for MathWorks Products

The USENET newsgroup for MATLAB and related products, `comp.soft-sys.matlab`, is read by thousands of users worldwide. Access the newsgroup to ask or provide help or advice, and to share code or examples. You can view and search through a sizable archive of postings from the `comp.soft-sys.matlab` link on the Technical Support Web page. Select **Technical Support Knowledge Base** from the **Web** menu.

Workspace, Search Path, and File Operations

MATLAB Workspace	5-3
Workspace Browser	5-3
Viewing and Editing Workspace Variables Using the Array Editor	5-10
Search Path	5-14
How the Search Path Works	5-14
Viewing and Setting the Search Path	5-15
File Operations	5-20
Current Directory Field	5-20
Current Directory Browser	5-20
Viewing and Making Changes to Directories	5-22
Creating, Renaming, Copying, and Removing Directories and Files	5-23
Opening, Running, and Viewing the Content of Files	5-26
Finding and Replacing Content Within Files	5-28
Preferences for the Current Directory Browser	5-30

When you work with MATLAB, you'll need to understand these important aspects:

- **Workspace** – The workspace is the set of variables maintained in memory during a MATLAB session. Use the Workspace browser or equivalent functions to view the workspace.
- **Search path** – MATLAB uses a search path to find M-files and other MATLAB related files. Use the **Set Path** dialog box or equivalent functions to view and change the path.
- **File operations** – To search for, view, open, and make changes to MATLAB related directories and files, use the MATLAB Current Directory browser or equivalent functions.

MATLAB Workspace

The MATLAB workspace consists of the set of variables (named arrays) built up during a MATLAB session and stored in memory. You add variables to the workspace by using functions, running M-files, and loading saved workspaces. For example, if you type

```
t = 0:pi/4:2*pi;  
y = sin(t);
```

the workspace includes two variables, `y` and `t`, each having nine values.

Workspace Browser

Use the Workspace browser to perform operations on the MATLAB workspace. Equivalent functions are available and are documented for each feature of the Workspace browser.

To open the Workspace browser, do one of the following:

- From the **View** menu in the MATLAB desktop, select **Workspace**.
- In the Launch Pad, under MATLAB, double-click **Workspace**.
- Type `workspace` at the Command Window prompt.

The Workspace browser opens.

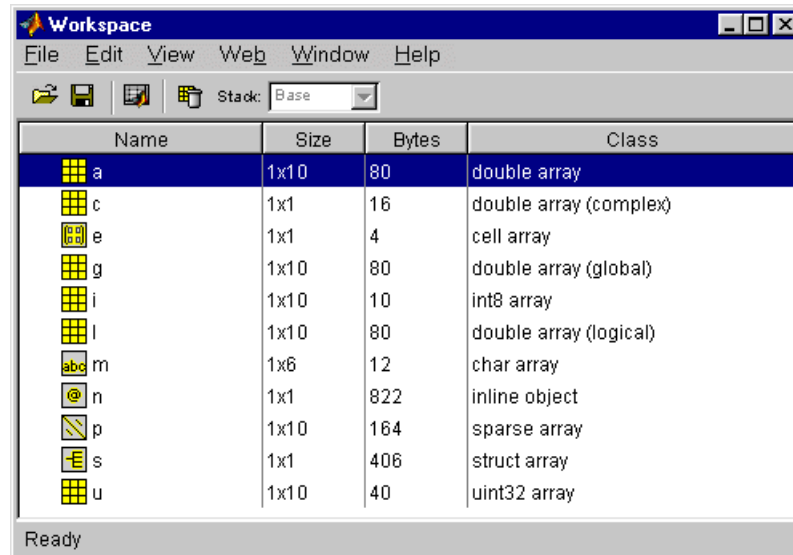

Workspace operations you can perform from the Workspace browser or with functions are:

- “Viewing the Current Workspace” on page 5-4
- “Saving the Current Workspace” on page 5-5
- “Loading a Saved Workspace” on page 5-7
- “Clearing Workspace Variables” on page 5-8
- “Viewing Base and Function Workspaces Using the Stack” on page 5-8
- “Creating Graphics from the Workspace Browser” on page 5-9
- “Viewing and Editing Workspace Variables Using the Array Editor” on page 5-10

You can also set preferences – see “Preferences for the Workspace Browser” on page 5-9.

Viewing the Current Workspace

The Workspace browser shows the name of each variable, its array size, its size in bytes, and the class. The icon for each variable denotes its class.

To resize the columns of information, drag the column header borders. To show or hide any of the columns, or to specify the sort order, select **Workspace View Options** from the **View** menu.

You can select the column on which to sort in the Workspace browser as well as reverse the sort order of any column. Click on a column heading to sort on that column. Click on the column heading again to reverse the sort order in that column. For example, to sort on **Size**, click the column heading once. To change from ascending to descending, click on the heading again.

Function Alternative. Use `who` to list the current workspace variables. Use `whos` to list the variables and information about their size and class. For example:

```
who
Your variables are:
A           M           S           v

whos
Name      Size      Bytes  Class
A         4x4        128    double array
M         8x1       2368    cell array
S         1x1        398    struct array
v         5x9         90    char array
Grand total is 286 elements using 2984 bytes
```

Use the `exist` function to see if the specified variable is in the workspace.

Saving the Current Workspace

The workspace is not maintained across MATLAB sessions. When you quit MATLAB, the workspace is cleared. You can save any or all of the variables in the current workspace to a MAT-file, which is a MATLAB specific binary file. You can then load the MAT-file at a later time during the current or another session to reuse the workspace variables. MAT-files use a `.mat` extension. Note that the `.mat` extension is also used by Microsoft Access.

Saving All Variables. To save all of the workspace variables using the Workspace browser:

- 1 From the **File** or context menu, select **Save Workspace As**, or click the save button  in the Workspace browser toolbar.

The **Save** dialog box opens.

- 2 Specify the location and **File name**. MATLAB automatically supplies the .mat extension.
- 3 Click **Save**.

The workspace variables are saved under the MAT-file name you specified.

You can also save the workspace variables from the Command Window by selecting **Save Workspace As** from the **File** menu.

Saving Selected Variables. To save some but not all of the current workspace variables:

- 1 Select the variable in the Workspace browser. To select multiple variables, **Shift+click** or **Ctrl+click**.
- 2 Right-click and from the context menu, select **Save Selection As**.

The **Save to MAT-File** dialog box opens.

- 3 Specify the location and **File name**. MATLAB automatically supplies the .mat extension.
- 4 Click **Save**.

The workspace variables are saved under the MAT-file name you specified.

Function Alternative. To save workspace variables, use the save function followed by the filename you want to save to. For example,

```
save('june10')
```

saves all current workspace variables to the file june10.mat.

If you don't specify a filename, the workspace is saved to matlab.mat in the current working directory. You can specify which variables to save, as well as control the format in which the data is stored, such as ascii. For these and other

forms of the function, see the reference page for `save`. MATLAB provides additional functions for saving information – see Chapter 6, “Importing and Exporting Data.”

Loading a Saved Workspace

To load a workspace that you previously saved:

- 1 Click the load data button  on the toolbar in the Workspace browser, or right-click in the Workspace browser and select **Import Data** from the context menu.

The **Open** dialog box opens.

- 2 Select the MAT-file you want to load and click **Open**.

The variables and their values, as stored in the MAT-file, are loaded into the workspace.

You can also load a saved workspace using the Import Wizard. Select **Import Data** from the **File** menu and then select a file from the Import dialog box. The Import Wizard opens. Use the Import Wizard to open the saved workspace. For instructions, see “Using the Import Wizard with Binary Data Files” on page 6-20.

Function Alternative. Use `load` to open a saved workspace. For example,

```
load('june10')
```

loads all workspace variables from the file `june10.mat`.

Note If the saved MAT-file `june10` contains the variables `A`, `B`, and `C`, then loading `june10` places the variables `A`, `B`, and `C` back into the workspace. If the variables already exist in the workspace, they are overwritten with the variables from `june10`. For more information, see the reference page for `load`. MATLAB provides other functions for loading information – see Chapter 6, “Importing and Exporting Data.”

Clearing Workspace Variables

You can delete a variable, which removes it from the workspace.

To clear a variable using the Workspace browser:

- 1 In the Workspace browser, select the variable, or **Shift**+click or **Ctrl**+click to select multiple variables. To select all variables, choose **Select All** from the **Edit** or context menus.
- 2 Do one of the following to clear the selected variables:
 - Press the **Delete** key.
 - From the **Edit** menu, select **Delete**.
 - Click the delete button  on the toolbar.
 - Right-click and select **Delete Selection** from the context menu.
- 3 A confirmation dialog box may appear. If it does, click **Yes** to clear the variables.

The confirmation dialog box appears if you specify it as a preference. See “Preferences for the Workspace Browser” on page 5-9 to change the preference.

To delete all variables at once, select **Clear Workspace** from the **Edit** menu, or from the context menu in the Workspace browser.

Function Alternative. Use the `clear` function. For example,

```
clear A M
```

clears the variables A and M from the workspace.

Viewing Base and Function Workspaces Using the Stack

When you run M-files, MATLAB assigns each function its own workspace, called the function workspace, which is separate from MATLAB’s base workspace. You can access the base and function workspaces when debugging M-files by using the **Stack** field in the Workspace browser. The **Stack** field is only available in debug mode; otherwise it is grayed out. The **Stack** field is also accessible from the Editor/Debugger. See “Debugging M-Files” on page 7-17 for more information.

Creating Graphics from the Workspace Browser

From the Workspace browser, you can generate a graph of a variable. Right-click on the variable you want to graph. From the context menu, select **Graph Selection** and then choose the type of graph you want to create. The graph appears in a figure window. For more information about creating graphs in MATLAB, see MATLAB graphics documentation.

Preferences for the Workspace Browser

You can specify as a preference the fonts to use in the Workspace browser and whether or not you want a confirmation dialog box to appear when you clear variables using the Workspace browser.

From the Workspace browser **File** menu, select **Preferences**. The **Preferences** dialog box opens to the **Workspace Preferences** panel.

Font. Workspace browser font preferences specify the characteristics of the font used in the Workspace browser. Select **Use desktop font** if you want the font in the Workspace browser to be the same as that specified for **General Font & Colors** preferences.

If you want the Workspace browser font to be different, select **Use custom font** and specify the font characteristics for the Workspace browser:

- Type, for example, SansSerif
- Style, for example, bold
- Size in points, for example, 12 points

After you make a selection, the **Sample** area shows how the font will look.

Confirm Deletion of Variables. Check the box for **Confirm deletion of variables** if you want a confirmation dialog box to appear when you delete a variable.

Viewing and Editing Workspace Variables Using the Array Editor

Use the Array Editor to view and edit a visual representation of one or two-dimensional numeric arrays, strings, and cell arrays of strings. The Array Editor features are:

- “Opening the Array Editor” on page 5-10
- “Changing Values of Elements in the Array Editor” on page 5-12
- “Controlling the Display of Values in the Array Editor” on page 5-12

In addition, you can set preferences. See “Preferences for the Array Editor” on page 5-12.

Opening the Array Editor

You can open the Array Editor from the Workspace browser:

- 1 In the Workspace browser, select the variable you want to open. **Shift**+click or **Ctrl**+click to select multiple
- 2 variables to open.
- 3 Click the open selection button  on the toolbar, or right-click and select **Open Selection** from the context menu.

Alternatively, for one variable, you can double-click it to open it.

The Array Editor opens, displaying the values for the selected variable.

You cannot open an array with 10,000 or more elements.

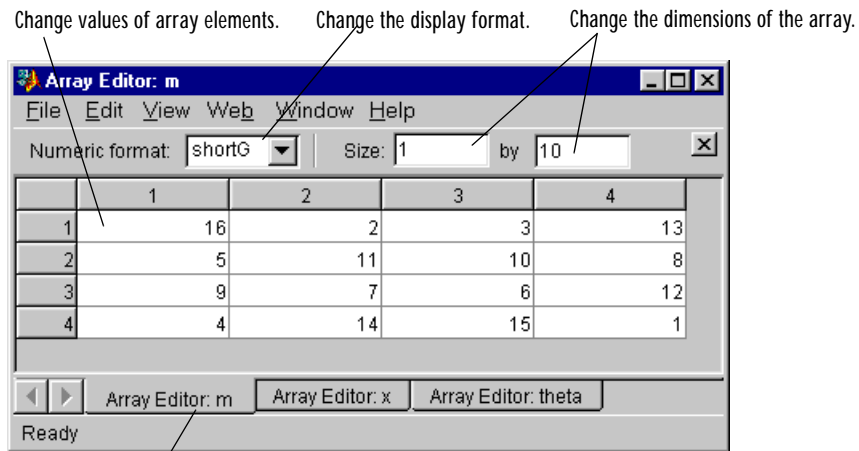

Use the tabs to view the different variables you have open in the Array Editor.

Repeat the steps to open additional variables in the Array Editor. Access each variable via its tab at the bottom of the window, or use the **Window** menu.

Function Alternative. To see the contents of a variable in the workspace, just type the variable name at the Command Window prompt. For example, type

```
m
```

and MATLAB returns

```
m =
    16     2     3    13
     5    11    10     8
     9     7     6    12
     4    14    15     1
```

To open a variable in the Array Editor, use `openvar` with the name of the variable you want to open as the argument. For example, type

```
openvar('m')
```

MATLAB opens `m` in the Array Editor.

Changing Values of Elements in the Array Editor

In the Array Editor, click in the cell whose value you want to change. Type a new value. Press **Enter** or **Return**, or click in another cell and the change takes effect.

To change the dimensions of an array, type the new values for the rows and columns in the **Size** fields. If you increase the size, the new rows and columns are added to the end and are filled with zeros. If you decrease the size, you will lose data – MATLAB removes rows and columns from the end. Some data types do not allow you to change the dimension; for these variables, the **Size** field is not editable.

If you opened an existing MAT-file and made changes to it using the Array Editor, you'll have to save that MAT-file if you want the changes to be saved. For instructions, see “Saving the Current Workspace” on page 5-5.

Controlling the Display of Values in the Array Editor

In the Array Editor, select an entry in the **Numeric format** list box to control how numeric values are displayed. For descriptions of the formats, see the reference page for `format`. The format applies only to the Array Editor display for that variable for the current session; it does not affect how MATLAB computes or saves the numeric value, nor does it affect the format used for display in the Command Window.

To specify a format for all variables in the Array Editor and keep it persistent across sessions, specify the format for the Array Editor using preferences as discussed in the next topic.

Preferences for the Array Editor

Using preferences for the Array Editor, you can specify the format for how numeric values are displayed, as well as their font type, style, and size.

To set preferences for the Array Editor, select **Preferences** from the **File** menu. The **Preferences** dialog box opens showing **Array Editor Preferences**.

Specify the **Font** and **Default format** preferences.

Font. Array Editor font preferences specify the characteristics of the font used in the Array Editor. Select **Use desktop font** if you want the font in the Array Editor to be the same as that specified for **General Font & Colors** preferences. If you want the Array Editor font to be different, select **Use custom font** and specify the font characteristics for the Array Editor:

- Type, for example, SansSerif
- Style, for example, bold
- Size in points, for example, 12 points

After you make a selection, the **Sample** area shows how the font will look.

Default Format. Specify the output format of numeric values displayed in the Array Editor. This affects only how numbers are displayed, not how MATLAB computes or saves them. For more information, see “Controlling the Display of Values in the Array Editor” on page 5-12 or see the reference page for format.

Search Path

MATLAB uses a *search path* to find M-files and other MATLAB related files, which are organized in directories on your file system. These files and directories are provided with MATLAB and associated toolboxes. Any file you want to run in MATLAB must reside in a directory that is on the search path or in the current directory. By default, the files supplied with MATLAB and MathWorks toolboxes are included in the search path.

If you create any MATLAB related files, add the directories containing the files to MATLAB's search path. When you create your own M-files or if you modify any MATLAB supplied M-files, save them in a directory that is *not* in `$matlabroot/toolbox/matlab`. If you do keep any of your files in `$matlabroot/toolbox/matlab`, they may be overwritten when you install a new version of MATLAB. In addition, you might need to restart MATLAB or use the `rehash` function before you use the new or updated file. This is because the locations of those files are loaded and cached in memory at the beginning of each MATLAB session to improve performance, and changes are not always recognized automatically.

For instructions to view and modify the search path, see “Viewing and Setting the Search Path” on page 5-15.

How the Search Path Works

The search path is also referred to as the *MATLAB path*. Files included are considered to be *on the path*. When you include a directory on the search path, you *add it to the path*. Subdirectories must be explicitly added to the path; they are not on the path just because their parent directories are. The search path is stored in the file `pathdef.m`.

The order of directories on the path is relevant. MATLAB looks for a named element, for example, `foo`, as described here. If you enter `foo` at the MATLAB prompt, MATLAB performs the following actions:

- 1 Looks for `foo` as a variable.
- 2 Checks for `foo` as a built-in function.
- 3 Looks in the current directory for a file named `foo.m`.
- 4 Searches the directories on the MATLAB search path, in order, for `foo.m`.

Although the actual search rules are more complicated because of the restricted scope of private functions, subfunctions, and object-oriented functions, this simplified perspective is accurate for the ordinary M-files you usually work with.

The order of the directories on the search path is important if there is more than one function with the same name. When MATLAB looks for that function, only the first one in the search path order is found; other functions with the same name are considered to be *shadowed* and cannot be executed. For more information, see “How MATLAB Determines Which Method to Call”.

To see the pathname used, use `which` for a specified function. For more information, see the reference page for `which`.

Viewing and Setting the Search Path

Use the **Set Path** dialog box to view and modify MATLAB’s search path and see files in directories that are on the path. Equivalent functions are documented for each feature of the **Set Path** dialog box.

Select **Set Path** from the **File** menu, or type `pathtool` at the Command Window prompt. The **Set Path** dialog box opens.

When you click one of these buttons, the change is made to the current search path. However, the search path is not automatically saved for future sessions.

Directories on the current MATLAB search path.

Make changes to the search path.

Save changes for use in future MATLAB sessions.

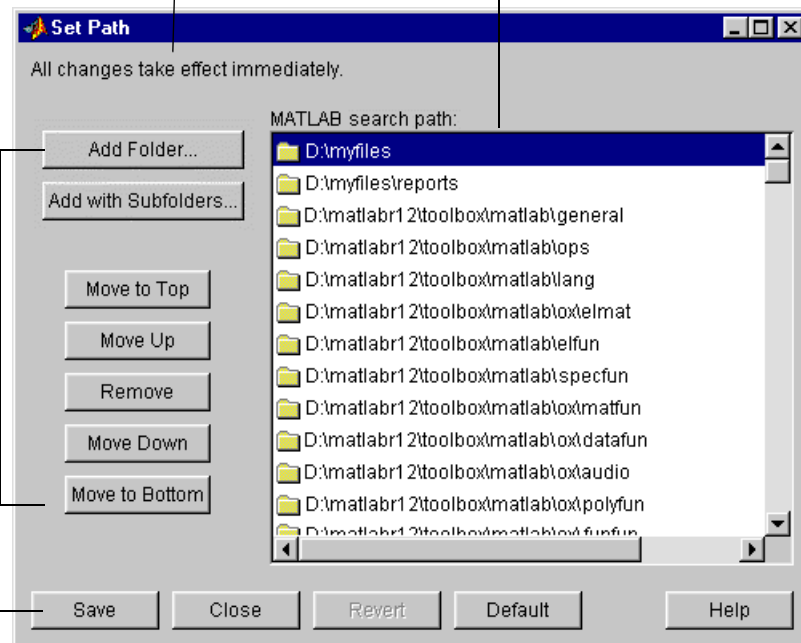

Use the Set Path dialog box for the following:

- “Viewing the Search Path” on page 5-17
- “Adding Directories to the Search Path” on page 5-17
- “Moving Directories within the Search Path” on page 5-17
- “Removing Directories from the Search Path” on page 5-18
- “Restoring the Default Search Path” on page 5-18
- “Reverting to the Previous Path” on page 5-18
- “Saving Settings to the Path” on page 5-18

Viewing the Search Path

The **MATLAB search path** field in the **Set Path** dialog box lists all of the directories on the search path.

Function Alternative. Use the `path` function to view the search path.

Adding Directories to the Search Path

To add directories to the MATLAB search path using the **Set Path** dialog box:

- 1 Click the **Add Folder** or the **Add with Subfolders** button.
 - If you want to add only the selected directory but do not want to add all of its subdirectories, click **Add Folder**.
 - If you want to add the selected directory and all of its subdirectories, click **Add with Subfolders**.

The **Browse for Folder** dialog box opens.

- 2 In the **Browse for Folder** dialog box, use the view of your file system to select the directory to add, and then click **OK**.

The selected directory, and subdirectories if specified, are added to the front (top) of the search path. They remain on the search path until you end the current MATLAB session. To use the newly modified search path in subsequent sessions, you need to save the path – see “Saving Settings to the Path” on page 5-18.

You cannot add method directories (directories that start with @) or private directories directly to the search path. Instead, add their parent directories.

Function Equivalent. To add directories to the search path, use `addpath`. The `addpath` function offers an option to get the path as a string and to concatenate multiple strings to form a new path.

You can include `addpath` in your startup M-file to automatically modify the path when MATLAB starts.

Moving Directories within the Search Path

The order of files on the search path is relevant – for more information, see “How the Search Path Works” on page 5-14.

To modify the order of directories within the search path, first select the directory you want to move. Then select one of the **Move** buttons, such as **Move to Top**. The top of the list corresponds to the front of the search path and the bottom of the list corresponds to the end of the search path.

The new order of files on the search path remains in effect until you end the current MATLAB session. To use the newly modified search path in subsequent sessions, you need to save the path – see “Saving Settings to the Path” on page 5-18.

Removing Directories from the Search Path

To remove directories from the MATLAB search path using the **Set Path** dialog box:

- 1 Select the directory to remove.
- 2 Click **Remove**.

The directory is removed from the search path for the remainder of the current MATLAB session. To use the newly modified search path in subsequent sessions, you need to save the path – see “Saving Settings to the Path” on page 5-18.

Function Equivalent. To remove directories from the search path, use `rmpath`.

You can include `rmpath` functions in your startup M-file to automatically modify the path when MATLAB starts.

Restoring the Default Search Path

To restore the default search path, click **Default** in the **Set Path** dialog box. This changes the search path so that it uses the factory settings.

Reverting to the Previous Path

To restore the previous path, click **Revert** in the **Set Path** dialog box. This cancels any unsaved changes you’ve made in the **Set Path** dialog box.

Saving Settings to the Path

When you make changes to the search path, they remain in effect during the current MATLAB session. To keep the changes in effect for subsequent

sessions, save the changes. To save changes using the **Set Path** dialog box, click **Save**.

The search path is stored in the `pathdef.m` file. By default, `pathdef.m` is stored in `$matlabroot\toolbox\local`. On Windows platforms, you can use a different `pathdef.m` if you store it in your startup directory – see “Startup Directory for MATLAB” on page 1-3.

You can directly edit `pathdef.m` with a text editor to change the path.

On UNIX workstations you may not have file system permission to edit `pathdef.m`. In this case, put `path` and `addpath` functions in your startup M-file to change your path defaults.

File Operations

MATLAB file operations use the current directory as a reference point. Any file you want to run must either be in the current directory or on the search path. Also, when you open a file in MATLAB, the starting point for the file open dialog box is the current directory. The keys tools for performing file operations are:

- Current directory field
- Current directory browser

Current Directory Field

A quick way to view or change the current directory is by using the **Current Directory** field in the desktop toolbar.



To change the current directory from this field, do one of the following:

- In the field, type the path for the new current directory.
- Click the down arrow to view a list of previous working directories, and select an item from the list to make that directory become MATLAB's current working directory. The directories are listed in order, with the most recently used at the top of the list. You can clear the list and set the number of directories saved in the list – see “Preferences for the Current Directory Browser” on page 5-30.
- Click the browse button (...) to set a new current directory.

Current Directory Browser

To search for, view, open, and make changes to MATLAB related directories and files, use the MATLAB Current Directory browser. Equivalent functions are documented for each feature of the Current Directory browser.

To open the Current Directory browser, select **Current Directory** from the **View** menu in the MATLAB desktop, or type `filebrowser` at the Command

Window prompt. You can also open it from the Launch Pad, under MATLAB. The Current Directory browser opens.

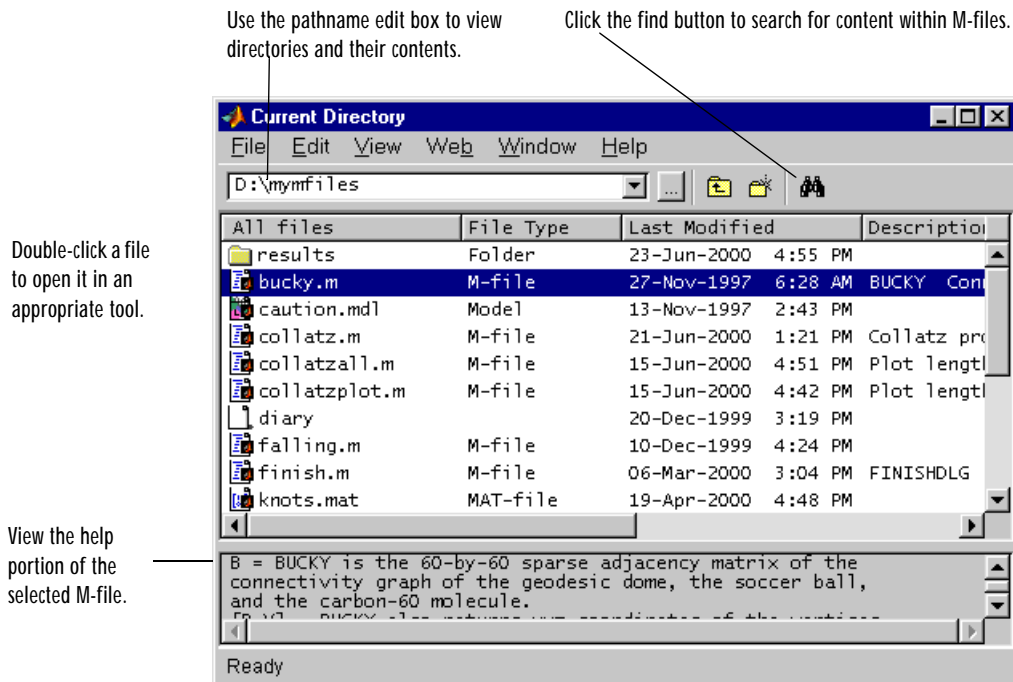

The main file operations you can perform using the Current Directory browser are:

- “Viewing and Making Changes to Directories” on page 5-22
- “Creating, Renaming, Copying, and Removing Directories and Files” on page 5-23
- “Opening, Running, and Viewing the Content of Files” on page 5-26
- “Finding and Replacing Content Within Files” on page 5-28

You can also set preferences – see “Preferences for the Current Directory Browser” on page 5-30.

Viewing and Making Changes to Directories

The ways to view and make changes to directories are:

- “Changing the Current Working Directory and Viewing Its Contents” on page 5-22
- “Adding Directories to the MATLAB Search Path” on page 5-23
- “Changing the Display” on page 5-23

Changing the Current Working Directory and Viewing Its Contents

To change the current directory, type the directory name in the pathname edit box in the Current Directory browser, and press the **Enter** or **Return** key. That directory becomes the current working directory and the files and subdirectories in it are listed.

To view a directory that has recently been displayed, click the down arrow at the right side of the pathname edit box in the Current Directory browser. The previously displayed directories are listed, sorted by most recent to least recent. Select an entry to view the contents of that directory. You can clear the list and set the number of directories saved in the list – see “Preferences for the Current Directory Browser” on page 5-30.

To view the contents of a subdirectory within the directory being displayed, double-click the subdirectory in the Current Directory browser, or select the subdirectory and press the **Enter** or **Return** key. You can also right-click on that subdirectory and select **Open** from the context menu.

To move up one level in the directory structure, click the up button  in the Current Directory browser toolbar, or press the **Back Space** key.

Function Alternative. Use `dir` to view the contents of the current working directory or another specified directory.

Use `what` to see only the MATLAB related files in a directory. With no arguments, `what` displays the MATLAB related files in the current working directory. Use `which` to display the pathname for the specified function. Use `exist` to see if a directory or file exists.

Adding Directories to the MATLAB Search Path

From the Current Directory browser, you can add directories to the MATLAB search path. Right-click and from the context menu, select **Add to Path**. Then select one of the options:

- **Current Directory** – Adds the current directory to the path.
- **Selected Folders** – Adds the directory selected in the Current Directory browser to the path.
- **Selected Folder and Subfolders** – Adds the directory selected in the Current Directory browser to the path, and adds all of its subdirectories to the path.

Changing the Display

To specify the types of files shown in the Current Directory browser, use **View -> Current Directory Filter**. For example, you can show only M-files.

You can sort the information shown in the Current Directory browser by column. Click the title of column on which you want to sort. The display is sorted, with the information in the that column shown in ascending order. Click a second time on the column title to sort the information in descending order.

If you make changes to the current directory from your file system, the Current Directory browser display won't immediately reflect those changes. Select **Refresh** from the context menu to update the Current Directory browser display.

Creating, Renaming, Copying, and Removing Directories and Files

If you have write permission, you can create, copy, remove, and rename MATLAB related files and directories for the directory shown in the Current Directory browser. If you do not have write permission, you can still copy files and directories to another directory.

Creating New Files

To create a new file in the current directory:

- 1 Select **New** from the context menu or **File** menu and then select the type of file to create.

An icon for that file type, for example, an M-file icon , with the default name `Untitled` appears at the end of the list of files shown in the Current Directory browser.

- 2 Type over `Untitled` with the name you want to give to the new file.
- 3 Press the **Enter** or **Return** key.

The file is added.

- 4 To enter the contents of the new M-file, open the file – see “Opening, Running, and Viewing the Content of Files” on page 5-26. If you created the file using the context menu, the new file opens with a template for writing an M-file function.

Create New Directories

To create a new directory in the current directory:

- 1 Click the new folder button  in the Current Directory browser toolbar, or select **New** -> **Folder** from context menu.

An icon, with the default name `NewFolder` appears at the end of the list of files shown in the Current Directory browser.

- 2 Type over `NewFolder` with the name you want to give to the new directory.
- 3 Press the **Enter** or **Return** key.

The directory is added.

Function Equivalent. To create a directory, use the `mkdir` function. For example,

```
mkdir ..\testdata newdir
```

creates the directory `newdir` within the directory `testdata`.

Renaming Files and Directories

To rename a file or directory, select the item, right-click, and select **Rename** from the context menu. Type over the existing name with the new name for the file or directory, and press the **Enter** or **Return** key. The file or directory is renamed.

Cutting or Deleting Files and Directories

To cut or delete files and directories:

- 1 Select the files and directories to remove. Use **Shift**+click or **Ctrl**+click to select multiple items.
- 2 Right-click and select **Cut** or **Delete** from the context menu. **Cut** is also available from the **Edit** menu.

The files and directories are removed.

Function Equivalent. To delete a file, use the delete function. For example,

```
delete('d:\myfiles\testfun.m')
```

deletes the file testfun.m.

Copying and Pasting Files

You can copy and paste files, but not directories. To copy and paste files:

- 1 Select the files. Use **Shift**+click or **Ctrl**+click to select multiple items.
- 2 Right-click and select **Copy** from the context menu, or select **Copy** from the **Edit** menu.
- 3 Move to the directory where you want to paste the files you just copied or cut.
- 4 Paste the files by right-clicking and selecting **Paste** from the context menu, or by selecting **Paste** from the **Edit** menu.

Opening, Running, and Viewing the Content of Files

Opening Files

You can open a file using the open feature of the Current Directory browser. The file opens in the tool associated with that file type.

To open a file, select one or more files and perform one of the following actions:

- Press the **Enter** or **Return** key.
- Right-click and select **Open** from the context menu.
- Double-click on the file(s).

The files open in the appropriate tools. For example, the Editor/Debugger opens for M-files, and Simulink opens for model (mdl) files.

To open any file in the Editor, no matter what type it is, select **Open as Text** from the context menu.

You can also import data from a file. Select the file, right-click, and select **Import Data** from the context menu. The Import Wizard opens. See Chapter 6, “Importing and Exporting Data” for instructions to import the data.

Function Alternative. Use the open function to open a file into the tool appropriate for the file, given its file extension. Default behavior is provided for standard MATLAB file types. You can extend the interface to include other file types and to override the default behavior for the standard files.

File Type	Extension	Action
Figure file	fig	Open figure in a figure window.
HTML file	html	Open HTML file name in the Help browser.
M-file	m	Open M-file name in the Editor.
MAT-file	mat	Open MAT-file name in the Import Wizard.
Model	mdl	Open model name in Simulink.
P-file	p	Open the corresponding M-file, name .m, if it exists, in the Editor.

File Type	Extension	Action (Continued)
Variable	not applicable	Open the numeric or string array name in the Array Editor; open calls <code>openvar</code> .
Other	custom	Open <code>name.custom</code> by calling the helper function <code>opencustom</code> , where <code>opencustom</code> is a user-defined function.

To view the content of an ASCII file, such as an M-file, use the `type` function. For example

```
type('startup')
```

displays the contents of the file `startup.m` in the Command Window.

Running M-Files

To run an M-file from the Current Directory browser, select it, right-click, and select **Run** from the context menu. The results appear in the Command Window.

Viewing Help for an M-File

You can view help for the M-file selected in the Current Directory browser. From the context menu, select **View Help**. The reference page for that function appears in the Help browser, or if a reference page does not exist, the M-file help appears.

You can view the M-file help in the Current Directory browser – for instructions, see “Preferences for the Current Directory Browser” on page 5-30.

Finding and Replacing Content Within Files

From the Current Directory browser, you can search for a specified string within files. If the file is open in the Editor, you can replace the specified string in a file.

Finding a Specified String Within a File

To search for a specified string in files:

- 1 Click the find button  in the Current Directory browser toolbar.

The **Find & Replace** dialog box appears. This provides the same features as the **Find & Replace** dialog box accessible from the Editor/Debugger.

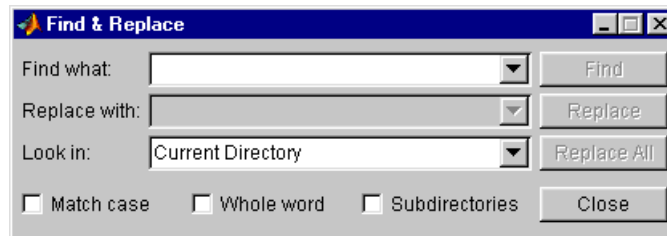

- 2 Complete the **Find & Replace** dialog box to find all occurrences of the string you specify.
 - Type the string in the **Find what** field.
 - Select the directories to search through from the **Look in** listbox, or type a directory name directly in this field.
 - Constrain the search by checking **Match case** or **Whole word**.
 - Check the box for **Subdirectories** if you want the search to also look through the subdirectories.

3 Click **Find**.

Results appear in the lower part of the **Find & Replace** dialog box and include the filename, M-file line number, and content of that line.

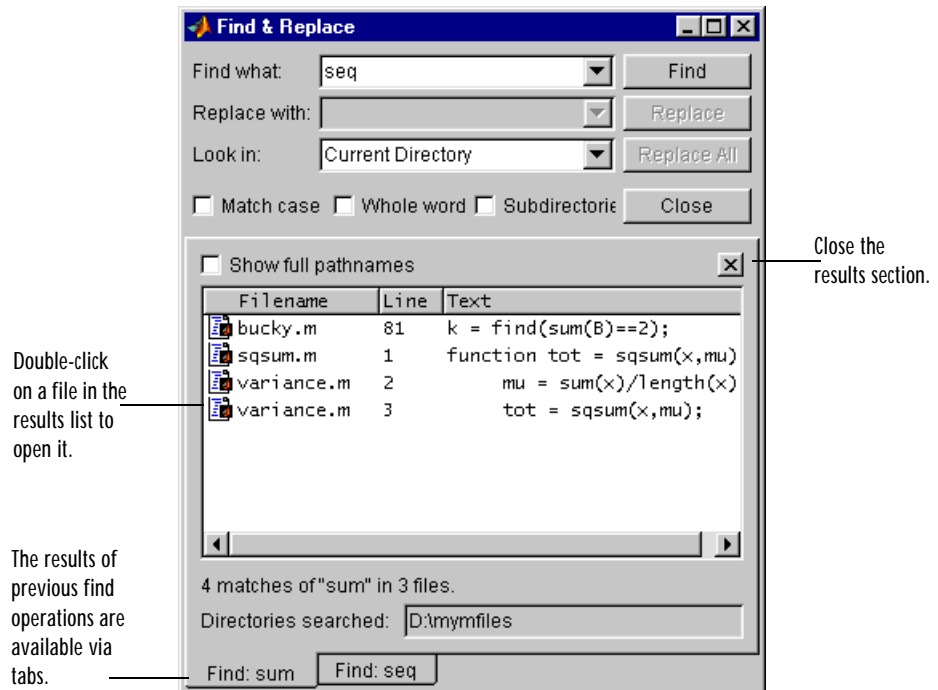

4 Open any M-file(s) in the results list by doing one of the following:

- Double-clicking the file(s)
- Selecting the file(s) and pressing the **Enter** or **Return** key
- Right-clicking the file(s) and selecting **Open** from the context menu

The M-file(s) opens in the Editor, scrolled to the line number shown in the results section of the **Find & Replace** dialog box.

5 If you perform another search, the results of each search are accessible via tabs just below the current results list. Click a tab to see that results list as well as the search criteria.

Function Equivalent. Use `lookfor` to search for the specified string in the first line of help in all M-files on the search path.

Replacing a Specified String Within Files

After searching for a string within a file, you can replace the string.

- 1 Open the file in MATLAB Editor. You can open the file from the Current Directory browser **Find & Replace** dialog box results list – see step 4 in “Finding a Specified String Within a File” on page 5-28. Be sure that the file in which you want to replace the string is the current file in the Editor.
- 2 In the **Look in** field in the **Find & Replace** dialog box, select the name of the file in which you want to replace the string.

The **Replace** button in the **Find & Replace** dialog box becomes selectable.

- 3 In the **Replace with** field, type the text that is to replace the specified string.
- 4 Click **Replace** to replace the string in the selected line, or click **Replace All** to replace all instances in the currently open file.

The text is replaced.

- 5 To save the changes, select **Save** from the **File** menu in the Editor.

Preferences for the Current Directory Browser

You can specify the number of recently used current directories to maintain in the history list as well as the type of information to display in the Current Directory browser using preferences.

From the Current Directory browser **File** menu, select **Preferences**. The **Current Directory Preferences** panel appears in the **Preferences** dialog box.

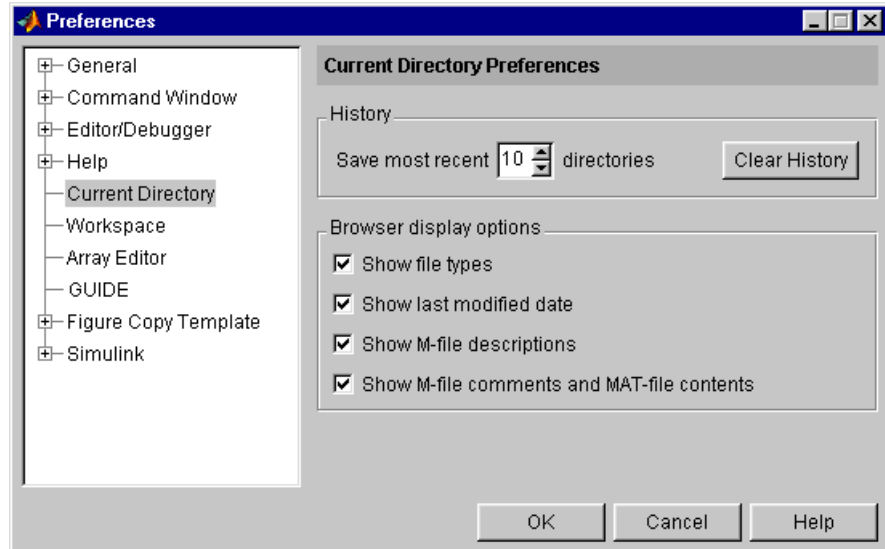

History

The drop down list in the Current Directory browser toolbar, as well as in the MATLAB desktop Current Directory field, show the most recently used current directories. The list contains all of the current directories used in the current MATLAB session.

Removing Directories. To remove the entries in the list, select **Clear History**. The list is cleared immediately.

Saving Directories. When the MATLAB session ends, the list of directories will be maintained. Use the **Save most recent directories** field to specify how many directories will appear on the list in at the start of the next MATLAB session.

Browser display options

In the Current Directory browser, you can view the file type, last modified date, M-file descriptions, and M-file comments and MAT-file contents by checking the appropriate **Browser display options**.

Importing and Exporting Data

Importing Text Data	6-4
Exporting ASCII Data	6-16
Importing Binary Data	6-20
Exporting Binary Data	6-25
Working with HDF Data	6-29
Using Low-Level File I/O Functions	6-51

MATLAB provides many ways to load data from disk files or the clipboard into the workspace, a process called *importing* data, and to save workspace variables to a disk file, a process called *exporting* data. Your choice of which mechanism to use depends on which operation you are performing, importing or exporting, and the format of the data, text or binary.

Note The easiest way to import data into MATLAB is to use the Import Wizard. When you use the Import Wizard, you do not need to know the format of the data. You simply specify the file that contains the data and the Import Wizard processes the file contents automatically. For more information, see “Using the Import Wizard with Text Data” on page 6-4 and “Using the Import Wizard with Binary Data Files” on page 6-20.

Text Data

In text formats, the data values are American Standard Code for Information Interchange (ASCII) codes that represent alphabetic and numeric characters. ASCII text data can be viewed in a text editor. For more information about working with text data, see:

- “Importing Text Data” on page 6-4
- “Exporting ASCII Data” on page 6-16

Binary Data

In binary format, the values are not ASCII codes and cannot be viewed in a text editor. Binary files contain data that represents images, sounds, and other formats. For more information about working with binary data, see:

- “Importing Binary Data” on page 6-20
- “Exporting Binary Data” on page 6-25

Other Formats

MATLAB also supports the importing of scientific data that uses the Hierarchical Data Format (HDF). See “Working with HDF Data” on page 6-29 for more information.

Low-Level File I/O

MATLAB also supports C-style, low-level I/O functions that you can use with any data format. For more information, see “Using Low-Level File I/O Functions” on page 6-51.

Importing Text Data

The easiest way to import text data into the workspace is to use the MATLAB Import Wizard. You simply start the Import Wizard and specify the file that contains the data you want to import. The Import Wizard can process most numeric data files automatically, even if they contain text headers. See “Using the Import Wizard with Text Data” below for more detailed information.

If you need to work from the MATLAB command line or perform import operations as part of an M-file, you must use one of the MATLAB import functions. Your choice of which function to use depends on the type of data in the file and how the data is formatted. MATLAB has functions that work with numeric data and other functions that can handle both alphabetic and numeric data. See “Using Import Functions with Text Data” on page 6-9 for more information about choosing the function that is right for your data.

Caution When you import data into the MATLAB workspace, you overwrite any existing variable in the workspace with the same name.

Using the Import Wizard with Text Data

To import text data using the Import Wizard, perform these steps:

- 1 Start the Import Wizard, by selecting the **Import Data** option on the MATLAB **File** menu. MATLAB displays a file selection dialog box. You can also use the `uiimport` function to start the Import Wizard.

To use the Import Wizard to import data from the clipboard, select the **Paste Special** option on the MATLAB **Edit** menu. You can also right-click in the MATLAB command window and choose **Paste Special** from the context menu. Skip to step 3 to continue importing from the clipboard.

- 2 Specify the file you want to import in the file selection dialog box and click **Open**. The Import Wizard opens the file and attempts to process its contents.
- 3 Specify the character used to separate the individual data items. This character is called the delimiter or column-separator. The Import Wizard

can determine the delimiter used in many cases. However, you may need to specify the character used in your text file. See “Specifying the Delimiter” on page 6-5 for more information. Once the Import Wizard has correctly processed the data, click **Next**.

- 4 Select the variables that you want to import. By default, the Import Wizard puts all the numeric data in one variable and all the text data in other variables but you can choose other options. See “Selecting the Variables to Import” on page 6-7 for more information.
- 5 Click **Finish** to import the data into the workspace.

Specifying the Delimiter

When the Import Wizard opens a text file, or copies data from the clipboard, it displays a portion of the raw data in the Preview pane of the dialog box. You can use this display to verify that the file contains the data you expected.

The Import Wizard also attempts to process the data, identifying the delimiter used in the data. The Import Wizard displays the variables it has created based on its interpretation of the delimiter, using tabbed panels to display multiple variables.

For example, in the following figure, the Import Wizard has opened this sample file, `grades.txt`.

John	85	90	95
Ann	90	92	98
Martin	100	95	97
Rob	77	86	93

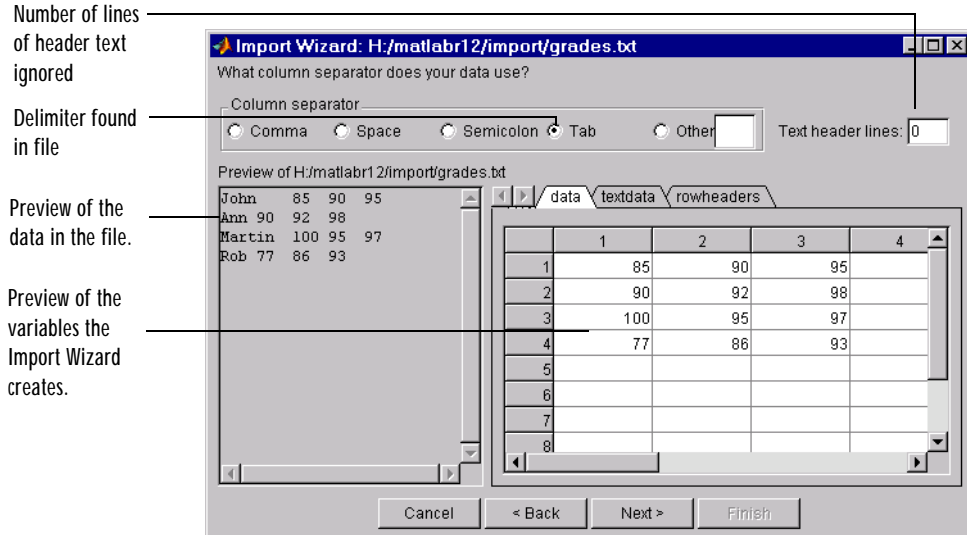

In the figure, note how the Import Wizard has correctly identified the tab character as the delimiter used in the file and has created three variables from the data:

- data -- containing all the numeric data in the file
- textdata -- containing all the text found in the file
- rowheaders -- containing the names in the left-most column of data.

Handling Alphabetic Data. The Import Wizard recognize data files that use row or column headers and extract these headers into separate variables. It can also ignore any text header lines that may precede the data in a file.

Specifying Other Delimiters. If the Import Wizard cannot determine the delimiter used in the data, it displays a preview of the raw data, as before, but the variables it displays will not be correct. If your data uses a character other than a comma, space, tab, or semicolon as a delimiter, you must specify it by clicking the **Other** button and entering the character in the text box. The Import Wizard immediately reprocesses the data, displaying the new variables it creates.

Selecting the Variables to Import

The Import Wizard displays a list of the variables it has created from your data. You can select which variables you want to import by clicking in the check box next to its name. By default, all variables are selected.

The Import Wizard displays the contents of the variable that is highlighted in the list in the right pane of the dialog box. To view the contents of one of the other variables, click on it. Choose the variables you want to import and click **Next**.

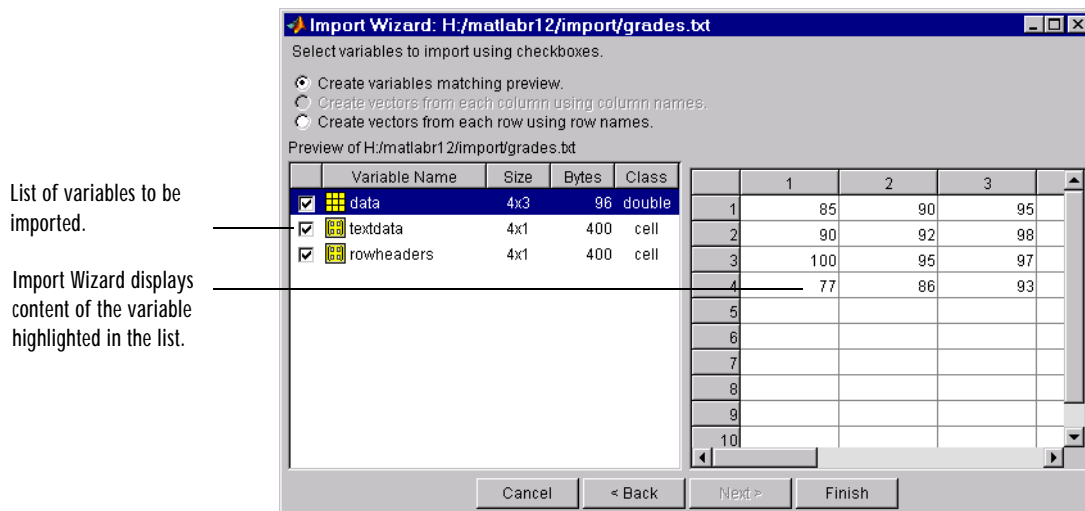

Changing the Variable Selection. By default, the Import Wizard puts all the numeric data in the file into one variable. If the file contains text data, the Import Wizard puts it in a separate variable. If the file contains row- or column-headers, the Import Wizard puts them in a separate variables, called rowheaders or colheaders, respectively.

In some cases, it might be more convenient to create variables out of each row or column of data and use the row headers or column header text as the name of each variable. To do this, click the appropriate button from the list of buttons at the top of the dialog box.

- Create variables matching preview.
- Create vectors from each column using column names.
- Create vectors from each column using row names.

For example, it would ease calculations of the student averages if we created separate variables for each student that contained that student's grades. To create these variables, click the **Create variables from each column using row names** button. When you click this option, the Import Wizard reprocesses the file creating these new variables.

Select option to create variables from row header.

List contains variables by row header.

Variable is a vector made from row of data file.

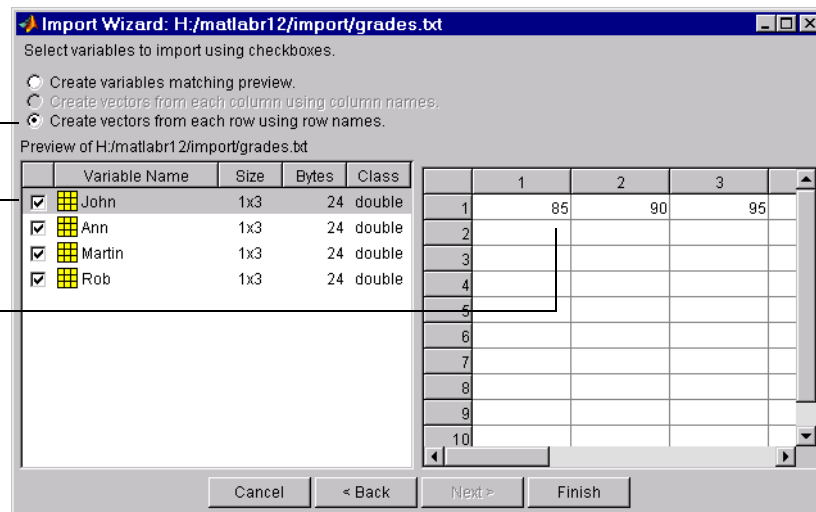

When you are satisfied with the list of variables to be imported, click **Next** to bring the data into the MATLAB workspace. This button also dismisses the Import Wizard. The Import Wizard displays a message in the MATLAB command window, reporting that it created variables in the workspace. In the following example, note how the numeric text data in each variable is imported as an array of doubles.

```
Import Wizard created variables in the current workspace.
>> whos
      Name          Size          Bytes  Class
      _____  _____  _____  _____
```



```

Ann          1x3          24 double array
John         1x3          24 double array
Martin       1x3          24 double array
Rob          1x3          24 double array

```

Grand total is 12 elements using 96 bytes

Using Import Functions with Text Data

To import text data from the command line or in an M-file, you must use one of the MATLAB import functions. Your choice of function depends on how the data in the text file is formatted.

The text data must be formatted in a uniform pattern of rows and columns, using a text character, called a *delimiter* or *column separator*, to separate each data item. The delimiter can be space, comma, semicolon, tab, or any other character. The individual data items can be alphabetic or numeric characters or a mix of both.

The text file may also contain one or more lines of text, called *header lines*, or may use text headers to label each column or row. The following example illustrates a tab-delimited text file with header text and row and column headers.

Text header line	_____				
		Class Grades for Spring Term			
Column Headers	_____	Grade1	Grade2	Grade3	
	John	85	90	95	
Row Headers	_____	Ann	90	92	98
	Martin	100	95	97	
	Rob	77	86	93	
Tab-delimited data	_____				

To find out how your data is formatted, view it in a text editor. After you determine the format, scan the data format samples in Table 6-1 and look for the sample that most closely resembles the format of your data. Read the topic referred to in the table for more information.

Table 6-1: ASCII Data File Formats and MATLAB Import Commands

Data Format Sample	File Extension	Description
1 2 3 4 5 6 7 8 9 10	.txt .dat or other	See “Importing Numeric Text Data” on page 6-11 for more information. You can also use the Import Wizard for this data format. See “Using the Import Wizard with Text Data” on page 6-4 for more information.
1; 2; 3; 4; 5 6; 7; 8; 9; 10 or 1, 2, 3, 4, 5 6, 7, 8, 9, 10	.txt .dat .csv or other	See “Importing Delimited ASCII Data Files” on page 6-12 for more information. You can also use the Import Wizard for this data format. See “Using the Import Wizard with Text Data” on page 6-4 for more information.
Ann Type1 12.34 45 Yes Joe Type2 45.67 67 No	.txt .dat or other	See “Importing Numeric Data with Text Headers” on page 6-13 for more information.
Grade1 Grade2 Grade3 91.5 89.2 77.3 88.0 67.8 91.0 67.3 78.1 92.5	.txt .dat or other	See “Importing Numeric Data with Text Headers” on page 6-13 for more information. You can also use the Import Wizard for this data format. See “Using the Import Wizard with Text Data” on page 6-4 for more information.

If you are familiar with MATLAB import functions but not sure when to use them, view Table 6-2 which compares the features of each function.

Table 6-2: ASCII Data Import Function Feature Comparison

Function	Data Type	Delimiters	Number of Return Values	Notes
csvread	Numeric data	Only commas	One	Primarily used with spreadsheet data. See also the binary format spreadsheet import functions.
dlmread	Numeric data	Any character	One	Flexible and easy to use.
fscanf	Alphabetic and numeric; however, both types returned in a single return variable	Any character	One	Part of low-level file I/O routines. Requires use of fopen to obtain file identifier and fclose after read.
load	Numeric data	Only spaces	One	Easy to use. Use the functional form of load to specify the name of the output variable.
textread	Alphabetic and numeric	Any character	Multiple return values.	Flexible, powerful, and easy to use. Use format string to specify conversions.

Importing Numeric Text Data

If your data file contains only numeric data, you can use many of the MATLAB import functions (listed in Table 6-2), depending on how the data is delimited. If the data is rectangular, that is, each row has the same number of elements, the simplest command to use is the `load` command. (The `load` command can also be used to import MAT-files, MATLAB's binary format for saving the workspace.)

For example, the file named `my_data.txt` contains two rows of numbers delimited by space characters.

```
1 2 3 4 5
6 7 8 9 10
```

When you use `load` as a command, it imports the data and creates a variable in the workspace with the same name as the filename, minus the file extension.

```
load my_data.txt;
whos
  Name          Size          Bytes   Class

  my_data       2x5           80     double array

my_data

my_data =
   1   2   3   4   5
   6   7   8   9  10
```

If you want to name the workspace variable something other than the file name, use the functional form of `load`. In the following example, the data from `my_data.txt` is loaded into the workspace variable `A`.

```
A = load('my_data.txt');
```

Importing Delimited ASCII Data Files

If your data file uses a character other than a space as a delimiter, you have a choice of several import functions you can use. (See Table 6-4 for a complete list.) The simplest to use is the `d1mread` function.

For example, consider a file named `ph.dat` whose contents are separated by semicolons.

```
7.2;8.5;6.2;6.6
5.4;9.2;8.1;7.2
```

To read the entire contents of this file into an array named `A`, enter

```
A = d1mread('ph.dat', ';');
```

You specify the delimiter used in the data file as the second argument to `d1mread`. Note that, even though the last items in each row are not followed by a delimiter, `d1mread` can still process the file correctly. `d1mread` ignores space characters between data elements. So, the preceding `d1mread` command works even if the contents of `ph.dat` are

```
7.2; 8.5;      6.2;6.6
5.4; 9.2 ;8.1;7.2
```

Importing Numeric Data with Text Headers

To import an ASCII data file that contains text headers, use the `textread` function, specifying the `headerlines` parameter. `textread` accepts a set of predefined parameters that control various aspects of the conversion. (For a complete list of these parameters, see the `textread` reference page.) The `headerlines` parameter lets you specify the number of lines at the head of the file that `textread` should ignore.

For example, the file, `grades.dat`, contains formatted numeric data with a one-line text header.

```
Grade1 Grade2 Grade3
78.8    55.9    45.9
99.5    66.8    78.0
89.5    77.0    56.7
```

To import this data, use this command:

```
[grade1 grade2 grade3] = textread('grades.dat','%f %f %f',...
'headerlines',1)
```

```
grade1 =
    78.8000
    99.5000
    89.5000
```

```
grade2 =
    55.9000
    66.8000
    77.0000
```

```
grade3 =  
    45.9000  
    78.0000  
    56.7000
```

Importing Mixed Alphabetic and Numeric Data

If your data file contains a mix of alphabetic and numeric ASCII data, use the `textread` function to import the data. `textread` can return multiple output variables and you can specify the data type of each variable.

For example, the file `mydata.dat` contains a mix of alphabetic and numeric data.

```
Sally    Type1 12.34 45 Yes  
Larry    Type2 34.56 54 Yes  
Tommy    Type1 67.89 23 No
```

Note To read an ASCII data file that contains primarily numeric data but with text column headers, see “Importing Numeric Data with Text Headers” on page 6-13.

To read the entire contents of the file `mydata.dat` into the workspace, specify the name of the data file and the format string as arguments to `textread`. In the format string, you include conversion specifiers that define how you want each data item to be interpreted. For example, specify `%s` for strings data, `%f` for floating point data, and so on. (For a complete list of format specifiers, see the `textread` reference page.)

For each conversion specifier in your format string, you must specify a separate output variable. `textread` processes each data item in the file as specified in the format string and puts the value in the output variable. The number of output variables must match the number of conversion specifiers in the format string.

In this example, `textread` reads the file `mydata.dat`, applying the format string to each line in the file until the end of the file.

```
[names,types,x,y,answer] = textread('mydata.dat','%s %s %f ...  
    %d %s',1)
```

```
names =
    'Sally'
    'Larry'
    'Tommy'

types =
    'Type1'
    'Type2'
    'Type1'

x =
    12.3400
    34.5600
    67.8900

y =
    45
    54
    23

answer =
    'Yes'
    'Yes'
    'No'
```

If your data uses a character other than a space as a delimiter, you must use the `textread` parameter `'delimiter'` to specify the delimiter. For example, if the file `mydata.dat` used a semicolon as a delimiter, you would use this command.

```
[names,types,x,y,answer]=textread('mydata.dat','%s %s %f ...
    %d %s', 'delimiter',';')
```

See the `textread` reference page for more information about these optional parameters.

Exporting ASCII Data

MATLAB supports several ways to export data in many different ASCII formats. For example, you may want to export a MATLAB matrix as text file where the rows and columns are represented as space-separated, numeric values.

This section describes how to use MATLAB functions to export data in several common ASCII formats, including:

- “Exporting Delimited ASCII Data Files” on page 6-17
- “Using the diary Command to Export Data” on page 6-18

The function you use depends on the amount of data you want to export and its format.

If you are not sure which section describes your data, scan the data format samples in Table 6-3 and look for the sample that most nearly matches the data format you want to create. Then, read the section referred to in the table.

If you are familiar with MATLAB export function but not sure when to use them, view Table 6-4, which compares the features of each function.

Note If C or Fortran routines for writing data files in the form needed by other applications exist, create a MEX file to write the data. See the *External Interfaces Guide* for more information.

Table 6-3: ASCII Data File Formats and MATLAB Export Commands

Data Format Sample	MATLAB Export Function
1 2 3 4 5 6 7 8 9 10	See “Exporting Delimited ASCII Data Files” on page 6-17 and “Using the diary Command to Export Data” on page 6-18 for information about these options.
1; 2; 3; 4; 5; 6; 7; 8; 9; 10;	See “Exporting Delimited ASCII Data Files” on page 6-17 for more information. The example shows a semicolon-delimited file but you can specify other characters as the delimiter.

Table 6-4: ASCII Data Export Function Feature Comparison

Function	Use With	Delimiters	Notes
csvwrite	Numeric data	Only commas	Primarily used with spreadsheet data. See also the binary format spreadsheet export functions
diary	Numeric data or cell array	Only spaces	Can be used for small arrays. Requires editing of data file to remove extraneous text.
dlmwrite	Numeric data	Any character	Easy to use, flexible.
fprintf	Alphabetic and numeric data	Any character	Part of low-level file I/O routines. Most flexible command but most difficult to use. Requires use of fopen to obtain file identifier and fclose after write.
save	Numeric data	Tabs or spaces	Easy to use; output values are high precision.

Exporting Delimited ASCII Data Files

To export an array as a delimited ASCII data file, you can use either the `save` command, specifying the `-ASCII` qualifier, or the `dlmwrite` function. The `save` command is easy to use; however, the `dlmwrite` function provides more flexibility, allowing you to specify any character as a delimiter and to export subsets of an array by specifying a range of values.

Using the `save` Command

To export the array `A`,

```
A = [ 1 2 3 4 ; 5 6 7 8 ];
```

use the `save` command, as follows.

```
save my_data.out A -ASCII
```

If you view the created file in a text editor, it looks like this.

```
1.0000000e+000 2.0000000e+000 3.0000000e+000 4.0000000e+000
5.0000000e+000 6.0000000e+000 7.0000000e+000 8.0000000e+000
```

By default, `save` uses spaces as delimiters but you can use tabs instead of spaces by specifying the `-tabs` qualifier.

When you use `save` to write a character array to an ASCII file, it writes the ASCII equivalent of the characters to the file. If you write the character string 'hello' to a file, `save` writes the values

```
104 101 108 108 111
```

Using the `dlmwrite` Function

To export an array in ASCII format and specify the delimiter used in the file, use the `dlmwrite` function.

For example, to export the array `A`,

```
A = [ 1 2 3 4 ; 5 6 7 8 ];
```

as an ASCII data file that uses semicolons as a delimiter, use this command

```
dlmwrite('my_data.out',A, ';')
```

If you view the created file in a text editor, it looks like this

```
1;2;3;4 5;6;7;8
```

Note that `dlmwrite` does not insert delimiters at the end of rows.

By default, if you do not specify a delimiter, `dlmwrite` uses commas as a delimiter. You can specify a space (' ') as a delimiter or, if you specify empty quotes (""), no delimiter.

Using the `diary` Command to Export Data

To export small numeric arrays or cell arrays, you can use the `diary` command. `diary` creates a verbatim copy of your MATLAB session in a disk file (excluding graphics).

For example, if you have the array, `A`, in your workspace

```
A = [ 1 2 3 4; 5 6 7 8 ];
```

execute these commands at the MATLAB prompt to export this array using `diary`:

- 1 Turn on the diary function. You can optionally name the output file `diary` creates.

```
diary my_data.out
```

- 2 Display the contents of the array you want to export. This example displays the array `A`. You could also display a cell array or other MATLAB data type.

```
A =  
    1    2    3    4  
    5    6    7    8
```

- 3 Turn off the diary function.

```
diary off
```

`diary` creates the file, `my_data.out`, and records all the commands executed in the MATLAB session until it is turned off.

```
A =  
    1    2    3    4  
    5    6    7    8
```

```
diary off
```

- 4 Open the diary file, `my_data.out`, in a text editor and remove all the extraneous text.

Importing Binary Data

The easiest way to import binary data is by using the Import Wizard. You simply start the Import Wizard and specify the file that contains the data you want to import. For more information, see “Using the Import Wizard with Binary Data Files” on page 6-20.

If you need to work from the MATLAB command line or perform import operations as part of an M-file, you must use one of the MATLAB import functions. MATLAB supports many functions to import data in different binary formats, such as image files or spreadsheet data files. Your choice of which function to use depends on the type of data in the file and how the data is formatted.

Caution When you import data into the MATLAB workspace, it overwrites any existing variables in the workspace with the same name.

Using the Import Wizard with Binary Data Files

To import text data using the Import Wizard, perform these steps:

- 1 Start the Import Wizard, by selecting the **Import Data** option on the MATLAB **File** menu. MATLAB displays a file selection dialog box. You can also use the `uiimport` function to start the Import Wizard.

To use the Import Wizard to import data from the clipboard, select the **Paste Special** option on the MATLAB **Edit** menu. You can also right-click in the MATLAB command window and choose **Paste Special** from the context menu. Skip to step 3 to continue importing from the clipboard.

- 2 Specify the file you want to import in the file selection dialog box and click **Open**. The Import Wizard opens the file and attempts to process its contents. See Viewing the variables for more information.
- 3 Select the variables that you want to import. By default, the Import Wizard creates variables depending on the type of data in the file.
- 4 Click **Finish** to import the data into the workspace.

Viewing the Variables

When the Import Wizard opens a binary data file, it attempts to process the data in the file, creating variables from the data it finds in the file.

For example, if you use the Import Wizard to import this sample MAT-file, `my_data.mat`,

```
A =
    1  2  3  4  5
    6  7  8  9 10
```

```
B =
    a test string
```

it creates two variables, listed in the Preview pane. You can select the variables you want to import by clicking in the check box next to its name. All variables are preselected by default.

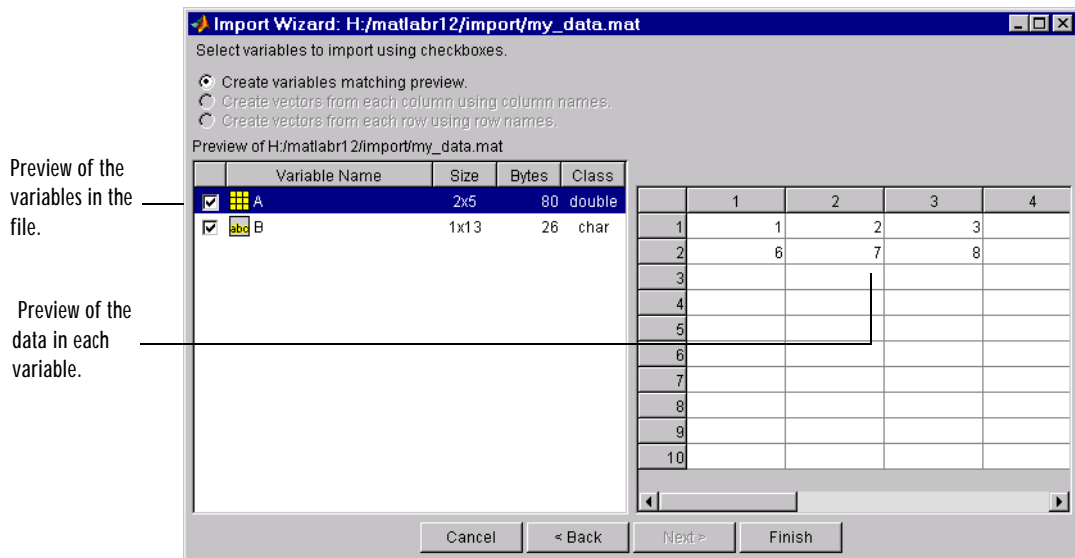

For other binary data types, such as images and sound files, the Import Wizard displays information about the data in the left pane and provides a Preview button in the right pane of the dialog box. Click the preview button to view (or listen to) the data.

For example, when used to import a movie in Audio Video Interleaved (AVI) format, the Import Wizard displays this dialog box..

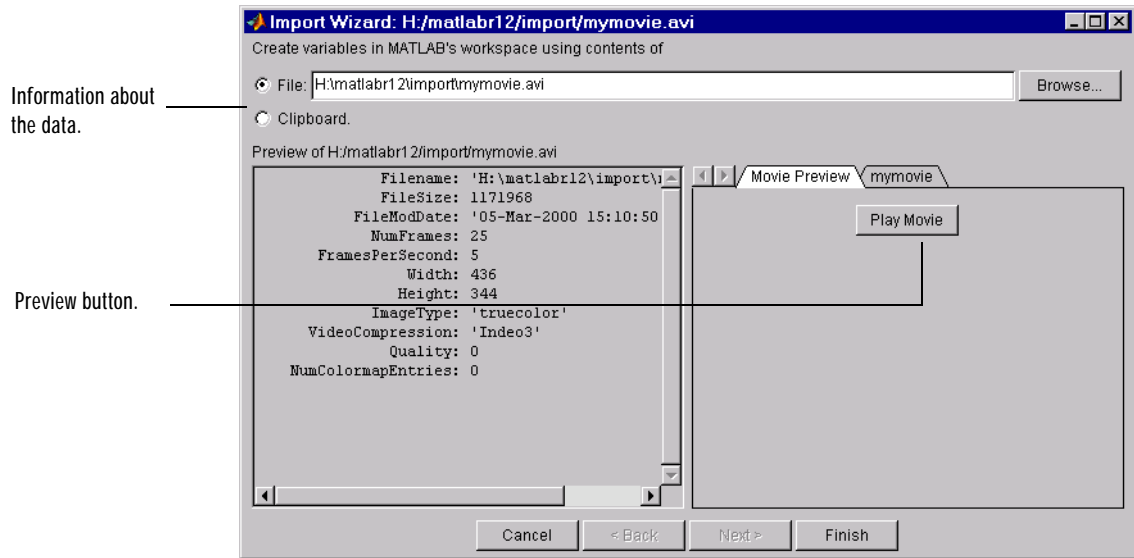

Using Import Functions with Binary Data

To import binary data from the command line or in an M-file, you must use one of the MATLAB import functions. Your choice of function depends on how the data in the text file is formatted.

To find the function designed to work with a particular binary data format, scan the data formats listed in Table 6-5. The table lists the binary formats and the MATLAB high-level functions you use to import them, along with pointers to additional information.

Table 6-5: Binary Data Formats and MATLAB Import Functions

Data Format	File Extension	Description
Audio files	.au .wav	Use the <code>auread</code> function to import audio files on Sun Microsystems platforms and the <code>wavread</code> function to import audio files on Microsoft Windows systems.
Audio-video Interleaved (AVI)	.avi	Use the <code>aviread</code> function to import Audio-video Interleaved (AVI) files.
Hierarchical Data Format (HDF)	.hdf	For HDF image files, use <code>imread</code> . For all other HDF files, see “Working with HDF Data” on page 6-29 for complete information.
Image files	.jpeg .tiff .bmp .gif .png .hdf .pcx .xwd	Use the <code>imread</code> function to import image data in many different formats. See Reading, Writing, and Querying Graphics Image Files for more information.
MATLAB proprietary format (MAT-files)	.mat	Use the <code>load</code> command to import data in MATLAB proprietary format. See “Loading a Saved Workspace” on page 5-7 for more information.
Spreadsheets	.xls .wk1	Use <code>xlsread</code> to import Excel spreadsheet data or <code>wk1read</code> to import Lotus 123 data.

To view the alphabetical list of MATLAB binary data export functions, see Table 6-6.

If MATLAB does not support a high-level function that works with a data format, you can use the MATLAB low-level file I/O functions, if you know how the binary data is formatted in the file. See “Using Low-Level File I/O Functions” on page 6-51 for more information.

Table 6-6: Binary Data Import Functions

Function	File Extension	Data Format
auread	.au	Import sound data in Sun Microsystems format.
aviread	.avi	Import audio-visual data in AVI format.
hdf	.hdf	Import data in Hierarchical Data Format (HDF). For HDF image file formats, use imread. For all other HDF files, see “Working with HDF Data” on page 6-29 for complete information.
imread	.jpeg, .tiff, .bmp, .png, .hdf, .pcx, .xwd, .gif	Import images in many formats.
load	.mat	Import MATLAB workspace variables in MAT-files format.
wavread	.wav	Import sound data in Microsoft Windows format.
wk1read	.wk1	Import data in Lotus 123 spreadsheet format.
xlsread	.xls	Import data in Microsoft Excel spreadsheet format.

Exporting Binary Data

To export binary data in one of the standard binary formats, you can use the MATLAB high-level function designed to work with that format.

To find the function designed to work with a particular binary data format, scan the data formats listed in Table 6-7. The table lists the binary formats and the MATLAB high-level functions you use to import them, with pointers to sources of additional information.

Table 6-7: Binary Data Formats and MATLAB Export Functions

Data Format	File Extension	Description
Audio files	.au .wav	Use the <code>auwrite</code> function to export audio files on Sun Microsystems platforms and the <code>wavwrite</code> function to export audio files in Microsoft Windows format.
Audio Video Interleaved (AVI)	.avi	You must use the <code>avifile</code> , <code>addframe</code> , and the <code>close</code> function overloaded for AVI data to export a sequence of MATLAB figures in AVI format. See “Exporting MATLAB Graphs in AVI Format” on page 6-27 for more information.
Hierarchical Data Format (HDF)	.hdf	To export image data in HDF format, use <code>imwrite</code> . For all other HDF formats, see “Working with HDF Data” on page 6-29 for complete information.
Image files	.jpeg .tiff .bmp .png .hdf .pcx .xwd	Use the <code>imwrite</code> function to export image data in many different formats. See <i>Reading, Writing, and Querying Graphics Image Files</i> for more information.

Data Format	File Extension	Description
MATLAB proprietary format (MAT-files)	.mat	Use the <code>save</code> command to export data in MATLAB proprietary format. See “Saving the Current Workspace” on page 5-5 for more information.
Spreadsheets	.xls .wk1	Use the <code>wk1write</code> function to export data in Lotus 123 format.

To view the alphabetical list of MATLAB binary data export functions, see Table 6-6.

If MATLAB does not support a high-level function that works with a data format, you can use the MATLAB low-level file I/O functions, if you know how the binary data is formatted in the file. See “Using Low-Level File I/O Functions” on page 6-51 for more information.

Table 6-8: Binary Data Export Functions

Function	File Extension	Data Format
<code>addframe</code>	.au	Capture snapshots of the current axes and put them in an AVI file object. See also <code>avifile</code> .
<code>auwrite</code>	.au	Export sound data in Sun Microsystems format.
<code>avifile</code>	.au	Export audio-visual data in AVI format. Creates an AVI file object. See also <code>addframe</code> .
<code>hdf</code>	.hdf	Export data in Hierarchical Data Format (HDF). For HDF image file formats, use <code>imwrite</code> . For all other HDF files, see “Working with HDF Data” on page 6-29 for complete information.
<code>imwrite</code>	.jpeg, .tiff, .bmp, .png, .hdf, .pcx, .xwd	Export image files in many formats.
<code>save</code>	.mat	Export MATLAB variables in MAT-files format.

Function	File Extension	Data Format
wavwrite	.wav	Export sound data on Microsoft Windows platforms.
wk1write	.wk1	Export data in Lotus 123 spreadsheet format.

Exporting MATLAB Graphs in AVI Format

In MATLAB, you can save a sequence of graphs as a *movie* that can then be played back using the `movie` function. You can export a MATLAB movie by saving it in MAT-file format, like any other MATLAB workspace variable. However, anyone who wants to view your movie must have MATLAB. (For more information about MATLAB movies, see the “Animation” section in *Using MATLAB Graphics*.)

To export a sequence of MATLAB graphs in a format that does not require MATLAB for viewing, save the figures in Audio Video Interleaved (AVI) format. AVI is a file format that allows animation and video clips to be played on a PC running Windows or on UNIX systems.

Creating an AVI Format Movie

To export a sequence of MATLAB graphs as an AVI format movie, perform these steps:

- 1 Create an AVI file, using the `avifile` function.
- 2 Capture the sequence of graphs and put them into the AVI file, using the `addframe` function.
- 3 Close the AVI file, using the `close` function, overloaded for AVI files.

Note To convert an existing MATLAB movie into an AVI file, use the `movie2avi` function.

For example, this code example exports a sequence of MATLAB graphs as the AVI file `mymovie.avi`. The numbers in comments correspond to notes following the code example.

```
aviobj = avifile('mymovie.avi','fps',5);

for k=1:25
    h = plot(fft(eye(k+16)));
    set(h,'EraseMode','xor');
    axis equal;
    frame = getframe(gca);
    aviobj = addframe(aviobj,frame);
end

aviobj = close(aviobj);
```

Note the following items in this code example:

- The `avifile` function creates an AVI file and returns a handle to an AVI file object. AVI file objects support properties that let you control various characteristics of the AVI movie, such as colormap, compression, and quality. (See the `avifile` reference page for a complete list.) `avifile` uses default values for all properties, unless you specify a value. In the example, the call to `avifile` explicitly sets the value of one frames per second (`fps`) property.
- The example uses a `for` loop to capture the series of graphs to be included in the movie. You typically use `addframe` to capture a sequence of graphs for AVI movies. However, because this particular MATLAB animation uses XOR graphics, you must call `getframe` to capture the graphs and then call `addframe` to add the captured frame to the movie. See the `addframe` reference page for more information.
- The example calls the `close` function to finish writing the frames to the file and to close the file.

Working with HDF Data

Hierarchical Data Format (HDF) is a general-purpose, machine-independent standard for storing scientific data in files. The National Center for Supercomputing Applications (NCSA), the original developer of HDF, distributes libraries of C and Fortran routines that scientists use to read and write data in HDF format.

This section describes how to call these NCSA routines from within MATLAB. Topics include:

- An overview of MATLAB HDF support
- MATLAB HDF function calling conventions
- Importing HDF data into the MATLAB workspace
- Exporting MATLAB data in an HDF file
- Including metadata in an HDF file
- Using MATLAB specific HDF functions

Additional Information Sources

This section does not attempt to describe all HDF features and routines. To use the MATLAB HDF interface effectively, you must use this documentation in conjunction with the official HDF documentation, available in many formats at the NCSA Web site (<http://hdf.ncsa.uiuc.edu/>). In particular, consult the following documentation:

- The *HDF User's Guide*, which describes key HDF concepts and programming models and provides tutorial information about using the library routines
- The *HDF Reference Manual*, which provides detailed reference information about the hundreds of HDF routines, their arguments, and return values

The National Aeronautics and Space Administration (NASA) has created an extension of HDF as one of the data standards for the Earth Observing System (EOS). For information about this extension to HDF, consult the official HDF-EOS documentation at the EOS Web site (<http://hdfeos.gsfc.nasa.gov/hdfeos/workshop.html>).

Finally, for details about the syntax of the MATLAB HDF functions, consult the MATLAB online Function Reference. For most HDF routines, the

MATLAB syntax is essentially the same as the HDF version; however, for certain routines, the MATLAB version has a different syntax.

Overview of MATLAB HDF Support

The NCSA organizes the routines in the HDF library into collections, called *External Interfaces (APIs)*. Each API works with particular type of data. For example, the HDF Scientific Data (SD) API works with multidimensional arrays of numeric data. Table , , lists all the HDF APIs supported by MATLAB (listed alphabetically by acronym). The table includes a MATLAB specific API made up of utility functions.

In addition to these standard HDF APIs, MATLAB also supports the EOS extension to HDF. HDF-EOS provides functions to store, manage, and retrieve multidimensional arrays of numeric data, point data, and swath data. See the HDF-EOS documentation for more information.

Note MATLAB supports the version 4.1r3 of the NCSA multifile APIs to HDF data. The multifile APIs replace the original NCSA APIs. MATLAB does not support HDF version 5.0, which is a completely new format and is not compatible with version 4.1r3.

Table 6-9: Supported HDF Application Programming Interfaces (APIs)

Application Programming Interface	Acronym	Description
Annotations	AN	Stores, manages, and retrieves text used to describe an HDF file or any of the data structures contained in the file.
General Raster Images	DF24 DFR8	Stores, manages, and retrieves raster images, their dimensions and palettes. It can also manipulate unattached palettes. Note: Use the MATLAB high-level functions <code>imread</code> and <code>imwrite</code> with HDF raster image formats.

Table 6-9: Supported HDF Application Programming Interfaces (APIs)

Application Programming Interface	Acronym	Description
HDF Utilities	H, HD, and HE	Provides functions to open and close HDF files and handle errors.
MATLAB HDF Utilities	ML	Provides utility functions that help you work with HDF files in the MATLAB environment.
Scientific Data	SD	Stores, manages, and retrieves multidimensional arrays of character or numeric data, along with their dimensions and attributes.
V Groups	V	Creates and retrieves groups of other HDF data objects, such as raster images or V data.
V Data	VS VF VH	Stores, manages, and retrieves multivariate data stored as records in a table.

MATLAB HDF Function Calling Conventions

Each HDF API includes many individual routines to read data from files, write data to files, and perform other related functions. For example, the HDF SD API includes separate C routines to open (SDopen), close (SDend), and read data (SDreaddata).

MATLAB, instead of supporting a corresponding function for each individual HDF API routine, supports a single function for each HDF API. You use this single function to access all the individual routines in the HDF API, specifying the name of the individual HDF routine as the first argument.

For example, to call the HDF SD API routine to terminate access to an HDF file in a C program, you use

```
status = SDend(sd_id);
```

To call this routine from MATLAB, use the MATLAB function associated with the API. By convention, the name of the MATLAB function associated with an HDF API includes the API acronym in the function name. For example, the MATLAB function used to access routines in the HDF SD API is called `hdfsd`.

As the first argument to this function, specify the name of the API routine, minus the acronym, and pass the remaining arguments expected by the routine in the order they are required. Thus, to call the `SDend` routine from MATLAB, use this syntax.

```
status = hdfsd('end',sd_id);
```

Note For some HDF API routines, particularly those that use output arguments to return data, the MATLAB calling sequence is different. (See “Handling HDF Routines with Output Arguments” on page 6-32 for more information.) Refer to the MATLAB online Function Reference to make sure you have the correct syntax.

Handling HDF Routines with Output Arguments

When calling HDF API routines that use output arguments to return data, you must specify all output arguments as return values. For example, in C syntax, the `SDfileinfo` routine returns data about an HDF file in two output arguments, `ndatasets` and `nglobal_atts`.

```
status = SDfileinfo(sd_id, ndatasets, nglobal_atts);
```

To call this routine from MATLAB, change the output arguments into return values.

```
[ndatasets, nglobal_atts, status] = hdfsd('fileinfo',sd_id);
```

Specify the return values in the same order as they appear as output arguments. The function status return value is always specified last.

Handling HDF Library Symbolic Constants

The C versions of the HDF APIs use symbolic constants, defined in header files, to specify modes and data types. For example, the `SDstart` routine uses a symbolic constant to specify the mode in which to open an HDF file.

```
sd_id = SDstart("my_file.hdf",DFACC_RDONLY);
```

When calling this routine from MATLAB, specify these constants as text strings.

```
sd_id = hdfsd('start','my_file.hdf','DFACC_RDONLY')
```

In MATLAB, you can specify the entire constant or leave off the prefix. For example, in this call to `SDstart`, you can use any of these variations as the constant text string: `'DFACC_RDONLY'`, `'dfacc_rdonly'`, or `'rdonly'`. Note that you can use any combination of upper- and lower-case characters.

Importing HDF Data into the MATLAB Workspace

To import HDF data into MATLAB, you must use the routines in the HDF API associated with the particular HDF data type. Each API has a particular programming model, that is, a prescribed way to use the routines to open the HDF file, access data sets in the file, and read data from the data sets. (In HDF terminology, the numeric arrays stored in HDF files are called data sets.)

To illustrate this concept, this section details the programming model of one particular HDF API: the Scientific Data (SD) API. For information about working with other HDF APIs, see the official NCSA documentation.

Note The following sections, when referring to specific routines in the HDF SD API, use the C library name rather than the MATLAB function name. The MATLAB syntax is used in all examples.

The HDF SD Import Programming Model

To import data in HDF SD format, you must use API routines to perform these steps:

- 1 Open the file containing HDF SD data sets.
- 2 Select the data set in the file that you want to import.
- 3 Read the data from the data set.
- 4 Close access to the data set and HDF file.

There are several additional steps that you may also need to perform, such as retrieving information about the contents of the HDF file or the data sets in the file. The following sections provide more detail about the basic steps as well as optional steps.

Opening HDF Files

To import an HDF SD data set, you must first open the file containing the data set. In the HDF SD API, you use the `SDstart` routine to open the file and initialize the HDF interface. In MATLAB, you use the `hdfsd` function with `start` specified as the first argument.

`SDstart` accepts these arguments:

- A text string specifying the name of the file you want to open
- A text string specifying the mode in which you want to open it

For example, this code opens the file `mydata.hdf` for read access.

```
sd_id = hdfsd('start','mydata.hdf','read');
```

If `SDstart` can find and open the file specified, it returns an HDF SD file identifier, named `sd_id` in the example. Otherwise, it returns `-1`.

The HDF SD API supports several file access modes. You use a symbolic constant, defined by the HDF SD API, to specify each mode. In MATLAB, you specify these constants as text strings. You can specify the full HDF constant or one of the abbreviated forms listed in table.

HDF File Creation Mode	HDF Symbolic Constant	MATLAB String
Create a new file	'DFACC_CREATE'	'create'
Read access	'DFACC_RDONLY'	'read' or 'rdonly'
Read and write access	'DFACC_RDWR'	'rdwr' or 'write'

Retrieving Information About an HDF File

After opening a file, you can get information about what the file contains using the `SDfileinfo` routine. In MATLAB, you use the `hdfsd` function with `fileinfo` specified as the first argument. This function returns the number of data sets in the file and whether the file includes any global attributes. (For more information about global attributes, see “Retrieving Attributes from an HDF File” on page 6-35.)

As an argument, `SDfileinfo` accepts the SD file identifier, `sd_id`, returned by `SDstart`. In this example, the HDF file contains three data sets and one global attribute.

```
[ndatasets, nglobal_atts, stat] = hdfsd('fileinfo',sd_id)

ndatasets =
    3

nglobal_atts =
    1

status =
    0
```

Retrieving Attributes from an HDF File

HDF files are self-documenting, that is, they can optionally include information, called *attributes*, that describes the data the file contains. Attributes associated with an HDF file are called *global* attributes. (You can also associate attributes with data sets or dimensions. For more information about these attributes, see “Including Metadata in an HDF File” on page 6-47.)

In the HDF SD API, you use the `SDreadattr` routine to retrieve global attributes from an HDF file. In MATLAB, you use the `hdfsd` function, specifying `readattr` as the first argument. As other arguments, you specify:

- The HDF SD file identifier (`sd_id`) returned by the `SDstart` routine
- The index value specifying the attribute you want to view. HDF uses zero-based indexing so the first global attribute has an index value zero, the second has an index value one, and so on.

For example, this code returns the contents of the first global attribute, which is simply the character string 'my global attribute'.

```
attr_idx = 0;
[attr, status] = hdfsd('readattr', sd_id, attr_idx)

attr =
    my global attribute

stat =
    0
```

MATLAB automatically sizes the return value, `attr`, to fit the data in the attribute.

Retrieving Attributes by Name. Attributes have names as well as values. If you know the name of an attribute, you can use the `SDfindattr` function to determine its index value so you can retrieve it. In MATLAB, you use the `hdfsd` function, specifying `findattr` as the first argument.

As other arguments, you specify:

- The HDF SD file identifier, when searching for global attributes
- A text string specifying the name of the attribute

`SDfindattr` searches all the global attributes associated with the file. If it finds an attribute with this name, `SDfindattr` returns the index of the attribute. You can then use this index value to retrieve the attribute using `SDreadattr`.

This example uses `SDfindattr` to obtain the index for the attribute named `my_att` and then passes this index as an argument to `SDreadattr`.

```
attr_idx = hdfsd('findattr',sd_id,'my_att');  
[attr, status] = hdfsd('readattr', sd_id, attr_idx);
```

Selecting Data Sets in HDF Files

After opening an HDF file, you must specify the data set in the file that you want to read. An HDF file can contain multiple data sets. In the HDF SD API, you use the `SDselect` routine to select a data set. In MATLAB, you use the `hdfsd` function, specifying `select` as the first argument.

As arguments, this function accepts:

- The HDF SD file identifier (`sd_id`) returned by `SDstart`
- The index value specifying the attribute you want to view. HDF uses zero-based indexing so the first global attribute has an index value zero, the second has an index value one, and so on.

For example, this code selects the third data set in the HDF file identified by `sd_id`. If `SDselect` finds the specified data set in the file, it returns an HDF SD data set identifier, called `sds_id` in the example. If it cannot find the data set, it returns `-1`.

Note Do not confuse HDF SD *file* identifiers, named `sd_id` in the examples, with HDF SD *data set* identifiers, named `sds_id` in the examples.

```
sds_idx = 2; % HDF uses zero-based indexing.
sds_id = hdfsd('select',sd_id,sds_idx)
```

Retrieving Data Sets by Name

Data sets in HDF files can be named. If you know the name of the data set you are interested in, but not its index value, you can determine its index by using the `SDnametoindex` routine. In MATLAB, use the `hdfsd` function, specifying `nametoindex` as the first argument.

Getting Information About a Data Set

After you select a data set in an HDF file, you can obtain information about the data set, such as the number and size of the array dimensions. You need this information to read the data set using the `SDreaddata` function. (See “Reading Data from an HDF File” on page 6-39 for more information.)

In the HDF SD API, you use the `SDgetinfo` routine to gather this information. In MATLAB, use the `hdfsd` function, specifying `getinfo` as the first argument. In addition, you must specify the HDF SD data set identifier returned by `SDselect` (`sds_id`).

This table lists the information returned by `SDgetinfo`.

Data Set Information Returned	MATLAB Data Type
Name	Character array
Number of dimensions	Scalar
Size of each dimension	Vector
Data type of the data stored in the array	Character array
Number of attributes associated with the data set	Scalar

For example, this code retrieves information about the data set identified by `sds_id`.

```
[dsname, dsndims, dsdims, dstype, dsatts, stat] =  
    hdfsd('getinfo',sds_id)  
dsname =  
    A  
  
dsndims =  
    2  
  
dsdims =  
    5    3  
  
dstype =  
    double  
  
dsatts =  
    0  
  
stat =  
    0
```

Retrieving Data Set Attributes

Like HDF files, HDF SD data sets are self-documenting, that is, they can optionally include information, called *attributes*, that describes the data in the data set. Attributes associated with a data set are called *local* attributes. (You can also associate attributes with files or dimensions. For more information about these attributes, see “Including Metadata in an HDF File” on page 6-47.)

In the HDF SD API, you use the `SDreadattr` routine to retrieve local attributes. In MATLAB, use the `hdfsd` function, specifying `readattr` as the first argument. As other arguments, specify

- The HDF SD data set identifier (`sds_id`) returned by `SDselect`
- The index of the attribute you want to view. HDF uses zero-based indexing so the first attribute has the index value zero, the second has an index value one, and so on.

This code example returns the contents of the first attribute associated with a data set identified by `sds_id`. In this case, the value of the attribute is the

character string 'my local attribute'. MATLAB automatically sizes the return value, `ds_attr`, to fit the value of the attribute.

```
attr_idx = 0;
[ds_attr, status] = hdfsd('readattr', sds_id, attr_idx)

ds_attr =
    my local attribute

stat =
    0
```

Reading Data from an HDF File

After you open an HDF file and select a data set in the file, you can read the entire data set, or part of the data set. In the HDF SD API, you use the `SDreaddata` routine to read a data set. In MATLAB, use the `hdfsd` function, specifying `readdata` as the first argument. As other arguments, specify:

- The HDF SD data set identifier (`sds_id`) returned by `SDselect`
- The location in the data set where you want to start reading data, specified as a vector of index values, called the *start* vector in HDF terminology
- The number of elements along each dimension to skip between each read operation, specified as a vector scalar values, called the *stride* vector in HDF terminology
- The total number of elements to read along each dimension, specified as a vector of scalar values, called the *edges* vector in HDF terminology

For example, to read the entire contents of a data set containing this 3-by-5 matrix of numeric values

```
1 2 3 4 5
6 7 8 9 10
11 12 13 14 15
```

you could use this code.

```
[ds_name, ds_ndims, ds_dims, ds_type, ds_atts, stat] =
    hdfsd('getinfo', sds_id);

ds_start = zeros(1, ds_ndims); % Creates the vector [0 0]
ds_stride = [];
```

```
ds_edges = ds_dims;

[ds_data, status] =
    hdfsd('readdata',sds_id,ds_start,ds_stride,ds_edges);

disp(ds_data)
     1     2     3     4     5
     6     7     8     9    10
    11    12    13    14    15
```

In this example, note the following:

- The return values of `SDgetinfo` are used to specify the dimensions of the return values and as arguments to `SDreaddata`.
- To read from the beginning of a data set, specify zero for each element of the start vector (`ds_start`). Note how the example uses `SDgetinfo` to determine the length of the start vector.
- To read every element of a data set, specify one for each element of the stride vector or specify an empty array (`[]`).
- To read every element of a data set, set each element of the edges vector to the size of each dimension of the data set.

Note Use the dimensions vector returned by `SDgetinfo`, `dsdims`, to set the value of the edges vector because `SDgetinfo` returns these values in row-major order, the ordering used by HDF. MATLAB stores data in column-major order. An array referred to as a 3-by-5 array in MATLAB is described as a 5-by-3 array in HDF.

Reading a Portion of a Data Set

To read less than the entire data set, use the start, stride, and edges vectors to specify where you want to start reading data and how much data you want to read.

For example, this code fragment uses `SDreaddata` to read the entire second row of the sample data set.

```

1 2 3 4 5
6 7 8 9 10
11 12 13 14 15

```

Note that in the `start`, `stride`, and `edges` arguments, you must specify the dimensions in column-major order, that is, `[columns,rows]`. In addition, note that you must use zero-based indexing in these arguments.

```

ds_start = [0 1] % Start reading at the first column, second row
ds_stride = []; % Read each element
ds_edges = [5 1]; % Read a 1-by-5 vector of data

[ds_data, status] =
    hdfsd('readdata',sds_id,ds_start,ds_stride,ds_edges);

disp(ds_data)
    6     7     8     9    10

```

For more information about specifying ranges in data sets, see “Writing MATLAB Data to an HDF File” on page 6-44.

Closing HDF Files and HDF Data sets

After reading data from a data set in an HDF file, you must close access to the data set and the file. The HDF SD API includes functions to perform these tasks. See “Closing HDF Data Sets” on page 6-46 for more information.

Exporting MATLAB Data in an HDF File

To export data from MATLAB in an HDF file, you must use the functions in the HDF API associated with the HDF data type. Each API has a particular programming model, that is, a prescribed way to use the routines to open the HDF file, access data sets in the file, and write data to the data sets. (In HDF terminology, the numeric arrays stored in HDF files are called data sets.)

To illustrate this concept, this section details the programming model of one particular HDF API: the Scientific Data (SD) API. For information about working with other HDF APIs, see the official NCSA documentation.

The HDF SD Export Programming Model

The programming model for exporting HDF SD data involves these steps:

- 1 Create the HDF file, or open an existing one.
- 2 Create a data set in the file, or select an existing one.
- 3 Write data to the data set.
- 4 Close access to the data set and the HDF file.

You can optionally include information in the HDF file that describes your data. See “Including Metadata in an HDF File” on page 6-47 for more information.

Creating an HDF File

To export MATLAB data in HDF format, you must first create an HDF file, or open an existing one. In the HDF SD API, you use the `SDstart` routine. In MATLAB, use the `hdfsd` function, specifying `start` as the first argument. As other arguments, specify:

- A text string specifying the name you want to assign to the HDF file (or the name of an existing HDF file)
- A text string specifying the HDF SD interface file access mode

For example, this code creates an HDF file named `mydata.hdf`.

```
sd_id = hdfsd('start', 'mydata.hdf', 'DFACC_CREATE');
```

If it can create (or open) the file, `SDstart` returns an HDF SD file identifier, named `sd_id` in the example. Otherwise, it returns `-1`.

When you specify the `DFACC_CREATE` access mode, `SDstart` creates the file and initializes the HDF SD multifile interface. If you specify `DFACC_CREATE` mode and the file already exists, `SDstart` fails, returning `-1`. To open an existing HDF file, you must use HDF read or write modes. For information about using `SDstart` in these modes, see “Opening HDF Files” on page 6-34.

Creating an HDF Data Set

After creating the HDF file, or opening an existing one, you must create a data set in the file for each MATLAB array you want to export. In the HDF SD API, you use the `SDcreate` routine to create data sets. In MATLAB, you use the `hdfsd` function, specifying `create` as the first argument. To write data to an existing data set, you must obtain the HDF SD data set identifier. See “Selecting Data Sets in HDF Files” on page 6-36 for more information.

This table lists the other arguments to `SDcreate`.

Argument	MATLAB Data Type
Valid HDF SD file identifier	Returned from <code>SDstart</code>
Name you want assigned to the data set	Text string
Data type of the data set	Text string. For information about specifying data types, see “Importing HDF Data into the MATLAB Workspace” on page 6-33
Number of dimensions in the data set. This is called the <i>rank</i> of the data set in HDF terminology	Scalar numeric value
Size of each dimension	Vector

The values you assign to these arguments depend on the MATLAB array you want to export. For example, to export this MATLAB 3-by-5 array of doubles,

```
A = [ 1 2 3 4 5 ; 6 7 8 9 10 ; 11 12 13 14 15 ];
```

you could set the values of these arguments as in this code fragment.

```
ds_name = 'A';
ds_type = 'double';
ds_rank = ndims(A);
ds_dims = fliplr(size(A));

sds_id = hdfsd('create',sd_id,ds_name,ds_type,ds_rank,ds_dims);
```

If `SDcreate` can successfully create the data set, it returns an HDF SD data set identifier (`sds_id`). Otherwise, `SDcreate` returns -1.

Note In this example, note how the code fragment reverses the order of the values in the dimensions argument (`ds_dims`). This processing is necessary because the MATLAB `size` function returns the dimensions in column-major order and HDF expects to receive dimensions in row-major order.

Once you create a data set, you cannot change its characteristics. You can, however, modify the data it contains. To do this, initiate access to the data set, using `SDselect`, and write to the data set as described in “Writing MATLAB Data to an HDF File” on page 6-44.

Writing MATLAB Data to an HDF File

After creating an HDF file and creating a data set in the file, you can write data to the entire data set or just a portion of the data set. In the HDF SD API, you use the `SDwritedata` routine. In MATLAB, use the `hdfsd` function, specifying `writedata` as the first argument.

This table lists the other arguments to `SDwritedata`.

Argument	MATLAB Data Type
Valid data set identifier (<code>sds_id</code>)	Returned by <code>SDcreate</code>
Location in the data set where you want to start writing data, called the <i>start</i> vector in HDF terminology	Vector of index values
Number of elements along each dimension to skip between each write operation, called the <i>stride</i> vector in HDF terminology	Vector of scalar values
Total number of elements to write along each dimension, called the <i>edges</i> vector in HDF terminology	Vector of scalar values
MATLAB array to be written	Array of doubles

Note You must specify the values of the start, stride, and edges arguments in row-major order, rather than the column-major order used in MATLAB. Note how the example uses `fliplr` to reverse the order of the dimensions in the vector returned by the `size` function before assigning it as the value of the edges argument.

The values you assign to these arguments depend on the MATLAB array you want to export. For example, this code fragment writes this MATLAB 3-by-5 array of doubles,

```
A = [ 1 2 3 4 5; 6 7 8 9 10; 11 12 13 14 15 ];
```

into an HDF file.

```
ds_start = zeros(1:ndims(A)); % Start at the beginning
ds_stride = []; % Write every element.
ds_edges = fliplr(size(A)); % Reverse the dimensions.

stat = hdfsd('writedata',sds_id,
            ds_start, ds_stride, ds_edges, A)
```

If it can write the data to the data set, `SDwritedata` returns 0; otherwise, it returns -1.

Note `SDwritedata` queues write operations. To ensure that these queued write operations are executed, you must close the file, using the `SDend` routine. See “Closing an HDF File” on page 6-46 for more information. As a convenience, MATLAB provides a function, `MLcloseall`, that you can use to close all open data sets and file identifiers with a single call. See “Using the MATLAB HDF Utility API” on page 6-49 for more information.

Writing Data to Portions of Data Sets

To write less than the entire data set, use the start, stride, and edges vectors to specify where you want to start writing data and how much data you want to write.

For example, this code fragment uses `SDwritedata` to replace the values of the entire second row of the sample data set

```
1 2 3 4 5
6 7 8 9 10
11 12 13 14 15
```

with the vector, `B`.

```
B = [ 9 9 9 9 9]
```

In the example, the start vector specifies that you want to start the write operation in the first column of the second row. Note how HDF uses zero-based indexing and specifies the column dimension first. In MATLAB, you would specify this location as `(2, 1)`. The `edges` argument specifies the dimensions of the data to be written. Note that the size of the array of data to be written must match the edge specification.

```
ds_start = [0 1] % Start writing at the first column, second row.
ds_stride = []; % Write every element.
ds_edges = [5 1]; % Each row is a 1-by-5 vector.

stat = hdfsd('writedata',sds_id,ds_start,ds_stride,ds_edges,B);
```

Closing HDF Data Sets

After writing data to a data set in an HDF file, you must close access to the data set. In the HDF SD API, you use the `SDendaccess` routine to close a data set. In MATLAB, use the `hdfsd` function, specifying `endaccess` as the first argument. As the only other argument, specify a valid HDF SD data set identifier, `sds_id` in this example.

```
stat = hdfsd('endaccess',sds_id);
```

Closing an HDF File

After writing data to a data set and closing the data set, you must also close the HDF file. In the HDF SD API, you use the `SDend` routine. In MATLAB, use the `hdfsd` function, specifying `end` as the first argument. As the only other argument, specify a valid HDF SD file identifier, `sd_id` in this example.

```
stat = hdfsd('end',sd_id);
```

You must close access to all the data sets in an HDF file before closing it.

Note Closing an HDF file executes all the write operations that have been queued using `SDwritedata`. As a convenience, the MATLAB HDF Utility API provides a function, `MLcloseall`, that can close all open data set and file identifiers with a single call. See “Using the MATLAB HDF Utility API” on page 6-49 for more information.

Including Metadata in an HDF File

You can optionally include information in an HDF file that describes your data. HDF defines an separate annotation API, however, the HDF SD API includes an annotation capability. This section only describes the annotation capabilities of the HDF SD API. For information about the Annotation API, see the official NCSA documentation.

Types of Attributes

Using HDF SD API, you can associate attributes with three types of HDF objects:

- An entire HDF file – File attributes, also called *global* attributes, generally contain information pertinent to all the data sets in the file.
- A data set in and HDF file – Data set attributes, also called *local* attributes, describe individual data sets.
- A dimension of a data set – Dimension attributes provide information applicable to an individual data set dimension.

Multiple Attributes

You can associate multiple attributes with a single HDF object. HDF maintains an attribute index for each object. The attribute index is zero-based. The first value has the index value zero, the second has the value one, and so on. You access an attribute by its index value.

Each attribute has the format `name=value`, where `name` (called `label` in HDF terminology) is a text string up to 256 characters in length and `value` contains one or more entries of the same data type. A single attribute can have multiple values.

Associating Attributes with HDF SD Objects

In the HDF SD API, you use the `SDsetattr` routine to associate an attribute with a file, data set or dimension. In MATLAB, use the `hdfsd` function, specifying `setattr` as the first argument. As other arguments, specify

- A valid HDF SD identifier associated with the object. This value could be a file identifier (`sd_id`), a data set identifier (`sds_id`), or a dimension identifier (`dim_id`).
- A text string that defines the name of the attribute. The SD interface supports predefined attributes that have reserved names and, in some cases, data types. For information about these attributes, see “Creating Predefined Attributes” on page 6-48.
- The attribute value

For example, this code creates a global attribute, named `my_global_attr`, and associates it with the HDF file identified by `sd_id`.

```
status = hdfsd('setattr',sd_id,'my_global_attr','my_attr_val');
```

Note In the NCSA documentation, the `SDsetattr` routine has two additional arguments: data type and the number of values in the attribute. When calling this routine from MATLAB, you do not have to include these arguments. The MATLAB HDF function can determine the data type and size of the attribute from the value you specify.

Creating Predefined Attributes

Predefined attributes are identical to user-defined attributes except that the HDF SD API has already defined their names and data types. For example, the HDF SD API defines an attribute, named `coordsys`, in which you can specify the coordinate system used by the data set. Possible values of this attribute include the text strings `'cartesian'`, `'polar'`, and `'spherical'`.

Predefined attributes can be useful because they establish conventions that applications can depend on. The HDF SD API supports predefined attributes for data sets and dimensions only; there are no predefined attributes for files. For a complete list of the predefined attributes, see the NCSA documentation.

In the HDF SD API, you create predefined attributes the same way you create user-defined attributes, using the `SDsetattr` routine. In MATLAB, use the `hdfsd` function, specifying `setattr` as the first argument.

```
attr_name = 'cordsys';
attr_value = 'polar';

status = hdfsd('setattr',sds_id,attr_name,attr_value);
```

The HDF SD API also includes specialized functions for writing and reading the predefined attributes. These specialized functions, such as `SDsetdatastrs`, are sometimes easier to use, especially when reading or writing multiple related predefined attributes. You must use specialized functions to read or write the predefined dimension attributes.

Using the MATLAB HDF Utility API

In addition to the standard HDF APIs, listed in Table , , on page 6-30, MATLAB supports an API of utility functions that are designed to make using HDF in the MATLAB environment easier.

For example, the MATLAB utility API includes a function, `MLlistinfo`, which you can use to view all types of open HDF identifiers, such as HDF SD file identifiers. MATLAB updates these lists whenever HDF identifiers are created or closed.

This code obtains a list of all open HDF file and data set identifiers, using the `MLlistinfo` function. In this example, only two identifiers are open.

```
hdfml('listinfo')
No open RI identifiers
No open GR identifiers
No open grid identifiers
No open grid file identifiers
No open annotation identifiers
No open AN identifiers
Open scientific dataset identifiers:
  262144
Open scientific data file identifiers:
  393216
No open Vdata identifiers
No open Vgroup identifiers
```

```
No open Vfile identifiers
No open point identifiers
No open point file identifiers
No open swath identifiers
No open swath file identifiers
No open access identifiers
No open file identifiers
```

Closing All Open HDF Identifiers

To close all open HDF identifiers in a single call, use the `MLcloseall` function. This call closes all open HDF identifiers.

```
hdfml('closeall')
```

Using Low-Level File I/O Functions

MATLAB includes a set of low-level file I/O functions that are based on the I/O functions of the ANSI Standard C Library. If you know C, therefore, you are probably familiar with these routines.

For example, the MATLAB file I/O functions use the same programming model as the C language routines. To read or write data, you perform these steps:

- 1 Open the file, using `fopen`. `fopen` returns a file identifier which you use with all the other low-level file I/O routines.
- 2 Operate on the file.
 - a Read binary data using `fread`.
 - b Write binary data using `fwrite`.
 - c Read text strings from a file line-by-line using `fgets/fgetl`.
 - d Read formatted ASCII data using `fscanf`.
 - e Write formatted ASCII data using `fprintf`.
- 3 Close the file, using `fclose`.

This section also describes how these functions affect the current position in the file where read or write operations happen and how you can change the position in the file.

Note While the MATLAB file I/O commands are modeled on the C language I/O routines, in some ways their behavior is different. For example, the `fread` function is “vectorized,” that is, it continues reading until it encounters a text string or the end of file. These sections, and the MATLAB reference pages for these functions, highlight any differences in behavior.

Opening Files

Before reading or writing a text or binary file, you must open it with the `fopen` command.

```
fid = fopen('filename', 'permission')
```

Specifying the Permissions String

The permission string specifies the kind of access to the file you require. Possible permission strings include:

- `r` for reading only
- `w` for writing only
- `a` for appending only
- `r+` for both reading and writing

Note Systems such as Microsoft Windows that distinguish between text and binary files may require additional characters in the permission string, such as `'rb'` to open a binary file for reading.

Using the Returned File Identifier (`fid`)

If successful, `fopen` returns a nonnegative integer, called a *file identifier* (`fid`). You pass this value as an argument to the other I/O functions to access the open file. For example, this `fopen` statement opens the data file named `penny.dat` for reading.

```
fid = fopen('penny.dat', 'r')
```

If `fopen` fails, for example if you try to open a file that does not exist, `fopen`:

- Assigns `-1` to the file identifier.
- Assigns an error message to an optional second output argument. Note that the error messages are system dependent and are not provided for all errors on all systems. The function `ferror` may also provide information about errors.

It's good practice to test the file identifier each time you open a file in your code. For example, this code loops a readable filename is entered.

```

fid=0;
while fid < 1
    filename=input('Open file: ', 's');
    [fid,message] = fopen(filename, 'r');
    if fid == -1
        disp(message)
    end
end
end

```

Now assume that `nofile.mat` does not exist but that `goodfile.mat` does exist. On one system, the results are

```

Open file: nofile.mat
Cannot open file. Existence? Permissions? Memory? . . .

Open file: goodfile.mat

```

Opening Temporary Files and Directories

The `tempdir` and `tempname` commands assist in locating temporary data on your system.

Function	Purpose
<code>tempdir</code>	Get temporary directory name.
<code>tempname</code>	Get temporary filename.

You can create temporary files. Some systems delete temporary files every time you reboot the system. On other systems, designating a file as temporary may mean only that the file is not backed up.

A function named `tempdir` returns the name of the directory or folder that has been designated to hold temporary files on your system. For example, issuing `tempdir` on a UNIX system returns the `/tmp` directory.

MATLAB also provides a `tempname` function that returns a filename in the temporary directory. The returned filename is a suitable destination for temporary data. For example, if you need to store some data in a temporary file, then you might issue the following command first.

```

fid = fopen(tempname, 'w');

```

Note The filename that `tempname` generates is not guaranteed to be unique; however, it is likely to be so.

Reading Binary Data

The `fread` function reads all or part of a binary file (as specified by a file identifier) and stores it in a matrix. In its simplest form, it reads an entire file and interprets each byte of input as the next element of the matrix. For example, the following code reads the data from a file named `nickel.dat` into matrix `A`.

```
fid = fopen('nickel.dat','r');
A = fread(fid);
```

To echo the data to the screen after reading it, use `char` to display the contents of `A` as characters, transposing the data so it displays horizontally.

```
disp(char(A'))
```

The `char` function causes MATLAB to interpret the contents of `A` as characters instead of as numbers. Transposing `A` displays it in its more natural horizontal format.

Controlling the Number of Values Read

`fread` accepts an optional second argument that controls the number of values read (if unspecified, the default is the entire file). For example, this statement reads the first 100 data values of the file specified by `fid` into the column vector `A`.

```
A = fread(fid,100);
```

Replacing the number 100 with the matrix dimensions `[10 10]` reads the same 100 elements into a 10-by-10 array.

Controlling the Data Type of Each Value

An optional third argument to `fread` controls the data type of the input. The data type argument controls both the number of bits read for each value and the interpretation of those bits as character, integer, or floating-point values.

MATLAB supports a wide range of precisions, which you can specify with MATLAB specific strings or their C or Fortran equivalents.

Some common precisions include:

- 'char' and 'uchar' for signed and unsigned characters (usually 8 bits)
- 'short' and 'long' for short and long integers (usually 16 and 32 bits, respectively)
- 'float' and 'double' for single and double precision floating-point values (usually 32 and 64 bits, respectively)

Note The meaning of a given precision can vary across different hardware platforms. For example, a 'uchar' is not always 8 bits. `fread` also provides a number of more specific precisions, such as 'int8' and 'float32'. If in doubt, use these precisions, which are not platform dependent. Look up `fread` in online help for a complete list of precisions.

For example, if `fid` refers to an open file containing single-precision floating-point values, then the following command reads the next 10 floating-point values into a column vector `A`.

```
A = fread(fid,10,'float');
```

Writing Binary Data

The `fwrite` function writes the elements of a matrix to a file in a specified numeric precision, returning the number of values written. For instance, these lines create a 100-byte binary file containing the 25 elements of the 5-by-5 magic square, each stored as 4-byte integers.

```
fwriteid = fopen('magic5.bin','w');  
count = fwrite(fwriteid,magic(5),'int32');  
status = fclose(fwriteid);
```

In this case, `fwrite` sets the count variable to 25 unless an error occurs, in which case the value is less.

Controlling Position in a File

Once you open a file with `fopen`, MATLAB maintains a file position indicator that specifies a particular location within a file. MATLAB uses the file position indicator to determine where in the file the next read or write operation will begin. The following sections describe how to:

- Determine if the file position indicator is at the end of the file
- Move to specific location in the file
- Retrieve the current location of the file position indicator
- Reset the file position indicator to the beginning of the file

Determining End-of-file

The `fseek` and `ftell` functions let you set and query the position in the file at which the next input or output operation takes place:

- The `fseek` function repositions the file position indicator, letting you skip over data or back up to an earlier part of the file.
- The `ftell` function gives the offset in bytes of the file position indicator for a specified file.

The syntax for `fseek` is

```
status = fseek(fid,offset,origin)
```

`fid` is the file identifier for the file. `offset` is a positive or negative offset value, specified in bytes. `origin` is an origin from which to calculate the move, specified as a string.

'bof'	Beginning of file
'cof'	Current position in file
'eof'	End of file

Understanding File Position

To see how `fseek` and `ftell` work, consider this short M-file.

```
A = 1:5;  
fid = fopen('five.bin','w');  
fwrite(fid, A, 'short');  
status = fclose(fid);
```

This code writes out the numbers 1 through 5 to a binary file named `five.bin`. The call to `fwrite` specifies that each numerical element be stored as a short. Consequently, each number uses two storage bytes.

Now reopen `five.bin` for reading.

```
fid = fopen('five.bin','r');
```

This call to `fseek` moves the file position indicator forward 6 bytes from the beginning of the file.

```
status = fseek(fid,6,'bof');
```

File Position	bof	1	2	3	4	5	6	7	8	9	10	eof
File Contents		0	1	0	2	0	3	0	4	0	5	
File Position Indicator								↑				

This call to `fread` reads whatever is at file positions 7 and 8 and stores it in variable `four`.

```
four = fread(fid,1,'short');
```

The act of reading advances the file position indicator. To determine the current file position indicator, call `ftell`.

```
position = ftell(fid)
```

```
position =
```

```
8
```

File Position	bof	1	2	3	4	5	6	7	8	9	10	eof
File Contents		0	1	0	2	0	3	0	4	0	5	
File Position Indicator										↑		

This call to `fseek` moves the file position indicator back 4 bytes.

```
status = fseek(fid,-4,'cof');
```

File Position	bof	1	2	3	4	5	6	7	8	9	10	eof
File Contents		0	1	0	2	0	3	0	4	0	5	
File Position Indicator						↑						

Calling `fread` again reads in the next value (3).

```
three = fread(fid,1,'short');
```

Reading Strings Line-By-Line from Text Files

MATLAB provides two functions, `fgetl` and `fgets`, that read lines from formatted text files and store them in string vectors. The two functions are almost identical; the only difference is that `fgets` copies the newline character to the string vector but `fgetl` does not.

The following M-file function demonstrates a possible use of `fgetl`. This function uses `fgetl` to read an entire file one line at a time. For each line, the function determines whether an input literal string (`literal`) appears in the line.

If it does, the function prints the entire line preceded by the number of times the literal string appears on the line.

```
function y = litcount(filename, literal)
% Search for number of string matches per line.

fid = fopen(filename, 'rt');
y = 0;
while feof(fid) == 0
    tline = fgetl(fid);
    matches = findstr(tline, literal);
    num = length(matches);
    if num > 0
        y = y + num;
        fprintf(1, '%d:%s\n', num, tline);
    end
end
fclose(fid);
```

For example, consider the following input data file called `badpoem`.

```
Oranges and lemons,  
Pineapples and tea.  
Orangutans and monkeys,  
Dragonflys or fleas.
```

To find out how many times the string `'an'` appears in this file, use `litcount`.

```
litcount('badpoem','an')  
2: Oranges and lemons,  
1: Pineapples and tea.  
3: Orangutans and monkeys,
```

Reading Formatted ASCII Data

The `fscanf` function is like the `fscanf` function in standard C. Both functions operate in a similar manner, reading data from a file and assigning it to one or more variables. Both functions use the same set of conversion specifiers to control the interpretation of the input data.

The conversion specifiers for `fscanf` begin with a `%` character; common conversion specifiers include:

- `%s` to match a string
- `%d` to match an integer in base 10 format
- `%g` to match a double-precision floating-point value

You can also specify that `fscanf` skip a value by specifying an asterisk in a conversion specifier. For example, `%*f` means skip the floating point value in the input data; `%*d` means skip the integer value in the input data.

Differences Between the MATLAB `fscanf` and the C `fscanf`

Despite all the similarities between the MATLAB and C versions of `fscanf`, there are some significant differences. For example, consider a file named `moon.dat` for which the contents are as follows.

```
3.654234533  
2.71343142314  
5.34134135678
```

The following code reads all three elements of this file into a matrix named `MyData`.

```
fid = fopen('moon.dat','r');
MyData = fscanf(fid,'%g');
status = fclose(fid);
```

Notice that this code does not use any loops. Instead, the `fscanf` function continues to read in text as long as the input format is compatible with the format specifier.

An optional size argument controls the number of matrix elements read. For example, if `fid` refers to an open file containing strings of integers, then this line reads 100 integer values into the column vector `A`.

```
A = fscanf(fid,'%5d',100);
```

This line reads 100 integer values into the 10-by-10 matrix `A`.

```
A = fscanf(fid,'%5d',[10 10]);
```

A related function, `sscanf`, takes its input from a string instead of a file. For example, this line returns a column vector containing 2 and its square root.

```
root2 = num2str([2, sqrt(2)]);
rootvalues = sscanf(root2,'%f');
```

Writing Formatted Text Files

The `fprintf` function converts data to character strings and outputs them to the screen or a file. A format control string containing conversion specifiers and any optional text specify the output format. The conversion specifiers control the output of array elements; `fprintf` copies text directly.

Common conversion specifiers include:

- `%e` for exponential notation
- `%f` for fixed point notation
- `%g` to automatically select the shorter of `%e` and `%f`

Optional fields in the format specifier control the minimum field width and precision. For example, this code creates a text file containing a short table of the exponential function.

```
x = 0:0.1:1;
y = [x; exp(x)];
```

The code below writes `x` and `y` into a newly created file named `exptable.txt`.

```
fid = fopen('exptable.txt','w');
fprintf(fid,'Exponential Function\n\n');
fprintf(fid,'%6.2f %12.8f\n',y);
status = fclose(fid);
```

The first call to `fprintf` outputs a title, followed by two carriage returns. The second call to `fprintf` outputs the table of numbers. The format control string specifies the format for each line of the table:

- A fixed-point value of six characters with two decimal places
- Two spaces
- A fixed-point value of twelve characters with eight decimal places

`fprintf` converts the elements of array `y` in column order. The function uses the format string repeatedly until it converts all the array elements.

Now use `fscanf` to read the exponential data file.

```
fid = fopen('exptable.txt','r');
title = fgetl(fid);
[table,count] = fscanf(fid,'%f %f',[2 11]);
```

```
table = table';  
status = fclose(fid);
```

The second line reads the file title. The third line reads the table of values, two floating-point values on each line until it reaches end of file. `count` returns the number of values matched.

A function related to `fprintf`, `sprintf`, outputs its results to a string instead of a file or the screen. For example,

```
root2 = sprintf('The square root of %f is %10.8e.\n',2,sqrt(2));
```

Closing a File

When you finish reading or writing, use `fclose` to close the file. For example, this line closes the file associated with file identifier `fid`.

```
status = fclose(fid);
```

This line closes all open files.

```
status = fclose('all');
```

Both forms return 0 if the file or files were successfully closed or -1 if the attempt was unsuccessful.

MATLAB automatically closes all open files when you exit from MATLAB. It is still good practice, however, to close a file explicitly with `fclose` when you are finished using it. Not doing so can unnecessarily drain system resources.

Note Closing a file does not clear the file identifier variable `fid`. However, subsequent attempts to access a file through this file identifier variable will not work.

Editing and Debugging M-Files

Starting the Editor/Debugger	7-3
Creating a New M-File in the Editor/Debugger	7-4
Opening Existing M-Files in the Editor/Debugger	7-5
Opening the Editor Without Starting MATLAB	7-6
Closing the Editor/Debugger	7-6
Creating and Editing M-Files with the Editor/Debugger	7-8
Appearance of an M-File	7-8
Navigating in an M-File	7-11
Saving M-Files	7-15
Running M-Files from the Editor/Debugger	7-15
Printing an M-File	7-16
Closing M-Files	7-16
Debugging M-Files	7-17
Types of Errors	7-17
Finding Errors	7-17
Debugging Example – The Collatz Problem	7-18
Using Debugging Features	7-22
Preferences for the Editor/Debugger	7-35
General Preferences for the Editor/Debugger	7-36
Font & Colors Preferences for the Editor/Debugger	7-37
Display Preferences for the Editor/Debugger	7-38
Keyboard and Indenting Preferences for the Editor/Debugger	7-40
Printing Preferences for the Editor/Debugger	7-42

There are several methods for creating, editing, and debugging M-files, which are files containing MATLAB code.

Task	Option	Instructions
Creating and Editing M-files	MATLAB Editor	“Starting the Editor/Debugger” on page 7-3
	MATLAB Editor in stand-alone mode (without running MATLAB)	“Opening the Editor Without Starting MATLAB” on page 7-6
	Any text editor, such as Emacs or vi	Specify the other editor as the default using preferences – see “Editor” on page 7-36
Debugging M-files	General debugging tips	“Types of Errors” and “Finding Errors” on page 7-17
	MATLAB Debugger	“Using Debugging Features” on page 7-22
	MATLAB debugging functions	“Using Debugging Features” on page 7-22

Use preferences to set up the editing and debugging environment to best meet your needs.

To learn more about writing M-files, see “Programming and Data Types”.

Starting the Editor/Debugger

The MATLAB Editor/Debugger provides a graphical user interface for basic text editing features for any file type, as well as for M-file debugging. The Editor/Debugger is a single tool that you can use for editing, debugging, or both. There are various ways to start the Editor/Debugger – see the sections:

- “Creating a New M-File in the Editor/Debugger” on page 7-4
- “Opening Existing M-Files in the Editor/Debugger” on page 7-5
- “Opening the Editor Without Starting MATLAB” on page 7-6 (no Debugger)

After starting the Editor/Debugger, follow the instructions for:

- “Creating and Editing M-Files with the Editor/Debugger” on page 7-8
- “Debugging M-Files” on page 7-17
- “Closing the Editor/Debugger” on page 7-6

Following is an illustration of the Editor/Debugger opened to an existing M-file.

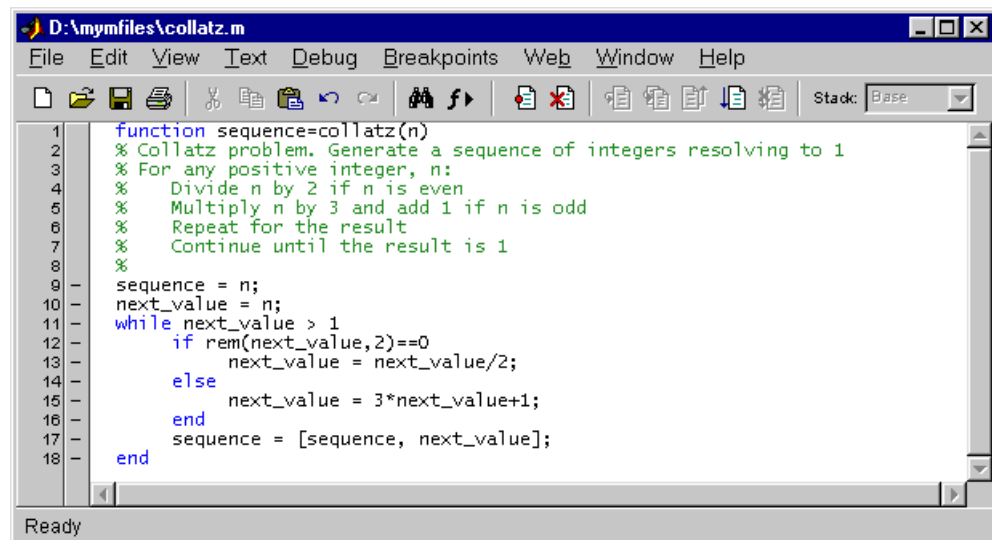

If the Editor/Debugger window is not wide enough, the toolbar buttons on the right will not be shown. The menu will wrap, and all toolbar functions are

available from equivalent menu items. To see all toolbar buttons, make the Editor/Debugger window wider.

To dock the Editor/Debugger inside the MATLAB desktop, select **Dock M-File** from the **View** menu.

To change the default appearance and behavior of the Editor/Debugger, follow the instructions in “Preferences for the Editor/Debugger” on page 7-35.

Creating a New M-File in the Editor/Debugger

To create a new M-file in the Editor/Debugger, either click the new file button  on the MATLAB toolbar, or select **File -> New -> M-file** from the MATLAB desktop. You can also create a new M-file using the context menu in the Current Directory browser – see “Creating New Files” on page 5-24. The Editor/Debugger opens, if it is not already open, with a blank file in which you can create an M-file.

If the Editor/Debugger is open, create more new files by using the new file button  on the toolbar, or select **File -> New -> M-file**.

Function Equivalent

Type `edit filename.m` in the Command Window to create a new M-file in the Editor/Debugger.

If you type `edit filename.m` and `filename.m` does not yet exist, a prompt appears asking if you want to create a new file titled `filename.m`.

- If you click **Yes**, the Editor/Debugger creates a blank file titled `filename.m`. If you do not want the dialog to appear in this situation, either check that box in the dialog or specify it in preferences for “Prompt” on page 7-40. In that case, the next time you type `edit filename.m`, the file will be created without first prompting you.
- If you click **No**, the Editor/Debugger does not create a new file. If you do not want the dialog to appear in this situation, either check that box in the dialog or specify it in preferences for “Prompt” on page 7-40. In that case, the next time you type `edit filename.m`, a “file not found” error will appear.

Opening Existing M-Files in the Editor/Debugger

To open an existing M-file in the Editor/Debugger, click the open button  on the MATLAB or Editor/Debugger toolbar, or select **File** -> **Open**. Then, from the **Open** dialog box, select the M-file and click **Open**. You can also open files from the Current Directory browser – see “Opening Files” on page 5-26.

You can select a file to open from the most recently used files, which are listed at the bottom of the **File** menu in the desktop as well as in the Editor/Debugger. You can change the number of files appearing on the list – see “Preferences for the Editor/Debugger” on page 7-35.

If the Editor/Debugger is not already open, it opens with the file displayed. If it is already open, the file appears either in its own window or as a tab in the current window as specified in “Opening files in editor” on page 7-38. To make a document in the Editor/Debugger become the current document, click on it or use the **Window** menu or tabs.

You can set a preference that instructs MATLAB on startup to automatically open the files that were open when the previous MATLAB session ended. For instructions, see the **On restart** preference in “General Preferences for the Editor/Debugger” on page 7-36.

Function Equivalent

Use the `edit` or `open` function to open an existing M-file in the Editor/Debugger. For example, type

```
edit collatz.m
```

to open the file `collatz.m` in the Editor/Debugger.

Opening a Selection

Within a file in the Editor/Debugger, select a function, right-click, and select **Open Selection** from the context menu. The file opens in the Editor/Debugger.

Getting Help for a Function

Within a file in the Editor/Debugger, select a function, right-click, and select **Help on Selection** from the context menu. The reference page for that function opens in the Editor/Debugger, or if the reference page does not exist, the M-file help is shown instead.

Accessing Your Source Control System

If you use a source control system for M-files, you can access it from within the Editor/Debugger to check out files. See Chapter 9, “Interfacing with Source Control Systems.”

Opening the Editor Without Starting MATLAB

On Windows platforms, you can use the MATLAB Editor without starting MATLAB. To do so, double-click an M-file in Windows Explorer. The M-file opens in the MATLAB Editor. To open the Editor without a file, open `$matlabroot/bin/win32/meditor.exe`. Regardless of the type of MATLAB license you have, you can open multiple instances of `meditor` because it is not considered an instance of MATLAB.

When you open the MATLAB Editor without starting MATLAB, the Editor is a stand-alone application. You cannot debug M-files from it, evaluate a selection, access source control features, dock the Editor in the MATLAB desktop, nor access help from it. It remains a stand-alone application, even if you subsequently open MATLAB. Other than these limitations, you can use the editing features as described in “Creating and Editing M-Files with the Editor/Debugger” on page 7-8.

For Windows platforms, when MATLAB is installed, the stand-alone Editor is automatically associated with files having a `.m` extension. If you double-click on an M-file, the stand-alone Editor opens. You can change the association using Windows Explorer so that files with a `.m` extension will open in the Editor/Debugger in MATLAB.

Closing the Editor/Debugger

To close the Editor/Debugger, click the close box in the title bar of the Editor/Debugger. This is different from the close box in the toolbar of the Editor/

Debugger, which closes the current file when multiple files are open in a single window.

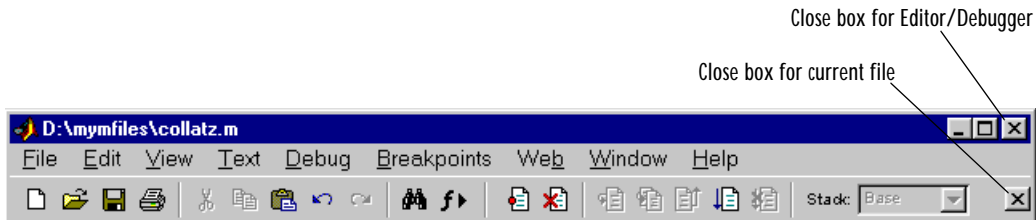

When you close the current file and it is the only file open, then the Editor/Debugger closes as well.

If multiple files are open with each in a separate Editor/Debugger window, close each window separately or close all of the files at once using the **Close All** item in the **Window** menu.

When you close the Editor/Debugger and any of the open files have unsaved changes, you will be prompted to save the files.

Creating and Editing M-Files with the Editor/Debugger

After opening an existing file or creating a new file, enter text in the Editor/Debugger. Follow the same rules you would use for entering text in the Command Window as described in these sections:

- “Case and Space Sensitivity” on page 3-4
- “Entering Multiple Functions in a Line” on page 3-4
- “Entering Long Lines” on page 3-5
- “Suppressing Output” on page 3-9
- “Controlling the Format and Spacing of Numeric Output” on page 3-10

Use the editing features described in these sections:

- “Appearance of an M-File” on page 7-8, including syntax highlighting
- “Navigating in an M-File” on page 7-11, including go to and find features
- “Saving M-Files” on page 7-15
- “Running M-Files from the Editor/Debugger” on page 7-15
- “Printing an M-File” on page 7-16
- “Closing M-Files” on page 7-16

Appearance of an M-File

The following features make M-files more readable:

- “Syntax Highlighting” on page 7-8
- “Indenting” on page 7-9
- “Commenting” on page 7-9
- “Showing Balanced Delimiters” on page 7-10

You can specify the default behavior for many of them – see “Preferences for the Editor/Debugger” on page 7-35.

Syntax Highlighting

Some entries appear in different colors to help you better find matching elements, such as `if/else` statements. For more information, see “Syntax Highlighting” on page 3-5.

Indenting

Flow control entries are automatically indented to aid in reading the loops, such as `while/end` statements.

To move the current or selected lines further to the left, select **Decrease Indent** from the **Text** menu. To move the current or selected lines further to the right, select **Increase Indent** from the **Text** menu. If after using these features you want to apply automatic indenting to selected lines, select **Smart Indent** from the **Text** menu, or right-click and select it from the context menu. For more information about smart indenting, see the preference for smart indent.

Commenting

You can comment the current line or a selection of lines. To select a line, click just to the left of the line – the line becomes highlighted. Drag or **Shift**+click to select multiple lines. Then select **Comment** from the **Text** menu, or right-click and select it from the context menu. A comment symbol, `%`, is added at the start of the line, and the color of the text becomes green.

You can make any line a comment by typing a `%` at the beginning of it. To put a comment within a line, type `%` followed by the comment text; MATLAB treats all the information after the `%` on that line as a comment.

You can also uncomment a selected group of lines – select **Uncomment** from the **Text** menu, or right-click and select it from the context menu.

Click in the area to the left of a line to select that line.
 Drag or Shift+click to select multiple lines as shown here.

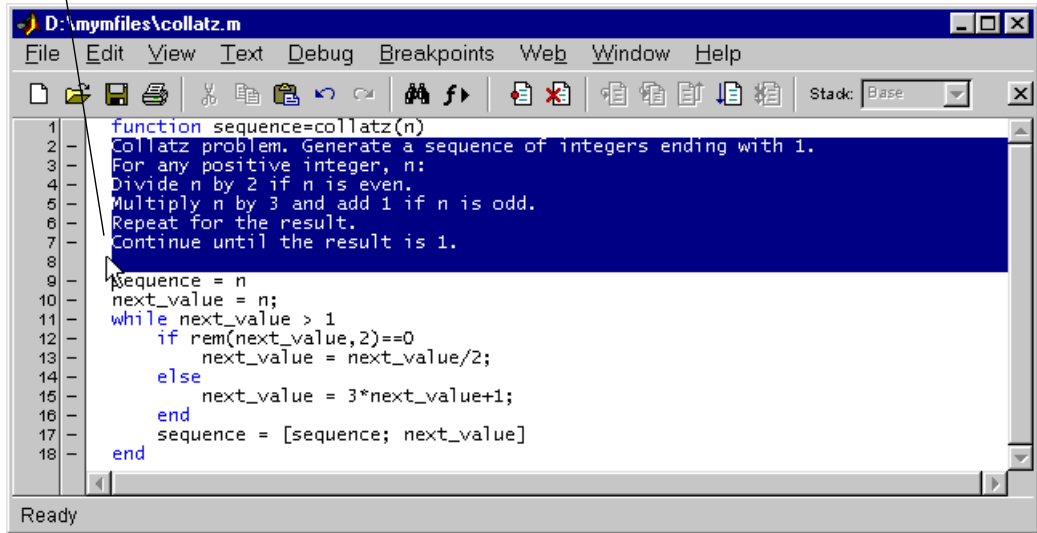

Showing Balanced Delimiters

When you position the cursor inside a pair of delimiters, that is, inside (), [], or {}, and select **Balance Delimiters** from the **Text** menu, the string inside the pair of delimiters is highlighted. In this example, when the cursor is positioned before /norm, as indicated here

```

alfa = asin(T*v'./sqrt(diag(T*T'))/norm(v));
    
```

selecting **Balance Delimiters** highlights the selection as shown here.

```

alfa = asin(T*v'./sqrt(diag(T*T'))/norm(v));
    
```

Navigating in an M-File

There are several options for navigating in M-files:

- “Going to a Line Number”
- “Going to a Bookmark”
- “Going to a Function”
- “Finding a Selection”
- “Finding and Replacing a String”

Going to a Line Number

Line numbers are displayed along the left side of the Editor/Debugger window. Select **Go to Line** from the **Edit** menu. Enter the line number in the edit box and click **OK**. The cursor moves to that line number in the current M-file.

Going to a Bookmark

You can set a bookmark at a line in an M-file so you can quickly go to the bookmarked line. This is particularly useful in long M-files. For example, if you’re working on a line but need to look at another part of the file, set a bookmark at the current line, go to the other part of the file, and then go back to the bookmark.

To set a bookmark, position the cursor anywhere in the line and select **Set Bookmark** from the **Edit** menu. A bookmark icon appears to the left of the line.

```
11 | -  while next_value > 1
```

To go to a bookmark, select **Next Bookmark** or **Previous Bookmark** from the **Edit** menu.

To clear a bookmark, position the cursor anywhere in the line and select **Clear Bookmark** from the **Edit** menu.

Bookmarks are not saved when you close a file.

Going to a Function

To go to a function in an M-file (referred to as a subfunction), click the function button  on the toolbar. Select the function you want to go to from the list of all functions in that M-file. The list does not include functions that are called from the M-file, but only lists lines in the current M-file that begin with a function statement.

Finding a Selection

Within the current M-file, select a string. From the **Edit** menu, select **Find Selection**. The next occurrence of that string becomes highlighted. Use **Find Selection** from the **Edit** menu to continue finding the next occurrences of the string.

To find the previous occurrence of the selected string (find backwards), press **Ctrl+Shift+F3**.

Finding and Replacing a String

You can search for a specified string within multiple files, and replace the string within a file.

Finding a String. To search for a string in files:

- 1 Click the find button  in the Editor/Debugger toolbar, or select **Find and Replace** from the **Edit** menu.

The **Find & Replace** dialog box appears. This provides the same features as the **Find & Replace** dialog box accessible from the Current Directory browser.

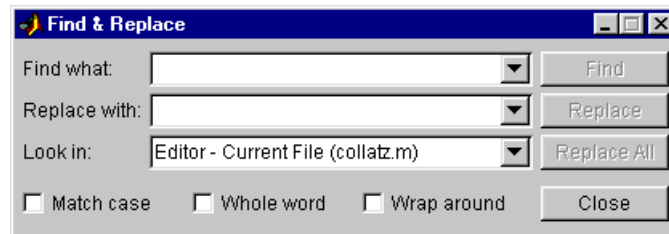

- 2 Complete the **Find & Replace** dialog box to find all occurrences of the string you specify.
 - a Type the string in the **Find what** field.
 - b Select the files to search through from the **Look in** listbox.
 - c Limit the search using **Match case**, **Whole word**, or **Wrap around**. These settings are remembered for your next MATLAB session.

3 Click Find.

- If you search for the current file, the next occurrence of the string is highlighted in the file.
- If the search is through multiple files, results appear in the lower part of the **Find & Replace** dialog box and include the filename, M-file line number, and content of that line.

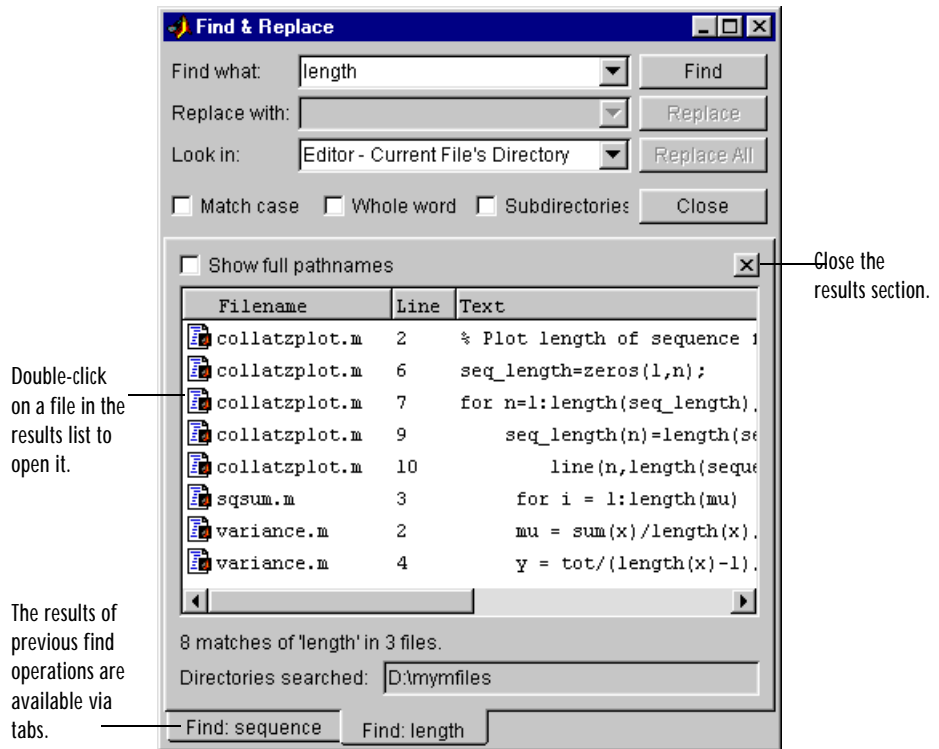

4 Open any M-file(s) in the results list by doing one of the following:

- Double-clicking it.
- Selecting it and pressing the **Enter** or **Return** key.
- Right-clicking it and selecting **Open** from the context menu.

The M-file opens, scrolled to the line number shown in the results section of the **Find & Replace** dialog box.

5 If you perform another search, the results of each search are accessible via tabs just below the results list. Click a tab to see that results list as well as the search criteria.

Finding the Next or Previous Occurrence of the String. To find the next occurrence of the string you entered in the **Find & Replace** dialog box, select **Find Next** from the **Edit** menu. To find the previous occurrence of that string (find backwards), press **Shift+F3**.

Function Equivalent. Use `lookfor` to search for the specified string in the first line of help in all M-files on the search path.

Replacing a String. After searching for a string within files, you can replace the specified content i

n the current file.

- 1 Open the file in the Editor if it's not already open. You can open it from the **Find & Replace** dialog box – see step 4 in “Finding a String” on page 7-12. Be sure that the file in which you want to replace the string is the current file in the Editor.
- 2 Be sure the **Look in** field in the **Find & Replace** dialog box shows the name of the file in which you want to replace the string. The **Replace** button in the **Find & Replace** dialog box becomes selectable.
- 3 In the **Replace with** field, type the text that is to replace the specified string.
- 4 Click **Replace** to replace the string in the selected line, or click **Replace All** to replace all instances in the currently open file.

The text is replaced.

5 To save the changes, select **Save** from the **File** menu.

You can repeat this for multiple files.

Saving M-Files

After making changes to an M-file, you will see an asterisk (*) next to the file name in the title bar of the Editor/Debugger. This indicates there are unsaved changes to the file.

To save the changes, use one of the **Save** commands in the **File** menu:

- **Save** – Saves the file to its existing name. If the file was newly created, the **Save file as** dialog box opens, where you assign a name to the file and save it. Another way to save is by using the save button  on the toolbar.
- **Save As** – The **Save file as** dialog box opens, where you assign a name to the file and save it. You do not need to type the `.m` extension because MATLAB automatically assigns the `.m` extension to the filename. If you do not want an extension, type a `.` (period) after the filename.
- **Save All** – Saves all named files to their existing filenames. For all newly created files, the **Save file as** dialog box opens, where you assign a name to each file and save it.

Running M-Files from the Editor/Debugger

You can run a script, that is, an M-file that doesn't require an input argument, directory from the Editor/Debugger by clicking the run button  on the toolbar, or by selecting **Run** from the **Debug** menu.

If the file is not in a directory on the search path or in the current directory, a dialog box appears presenting you with options that allow you to run the file. You can either change the current directory to the directory containing the file, or you can add to the search path the directory containing the file.

Note that if the file has unsaved changes, running it from the Editor/Debugger automatically saves the changes before running. In that event, the menu item becomes **Save and Run**.

See “Running an M-File with Breakpoints” on page 7-24 for additional information about running M-files while debugging.

Accessing Your Source Control System

If you use a source control system for M-files, you can access it from within the Editor/Debugger to check in files. See Chapter 9, “Interfacing with Source Control Systems.”

Printing an M-File

To print an entire M-file, select **Print** from the **File** menu, or click the print button  on the toolbar. To print the current selection, select **Print Selection** from the **File** menu. Complete the standard print dialog box that appears.

See also “Printing Preferences for the Editor/Debugger” on page 7-42 to specify a different font for printing, color or black and white printing, and other options.

Closing M-Files

To close the current M-file, select **Close filename** from the **File** menu. If there are multiple files open in a single Editor/Debugger window, click the close box in the Editor toolbar to close the current M-file. This is different from the close box in the titlebar of the Editor/Debugger, which closes the Editor/Debugger, including all open files.

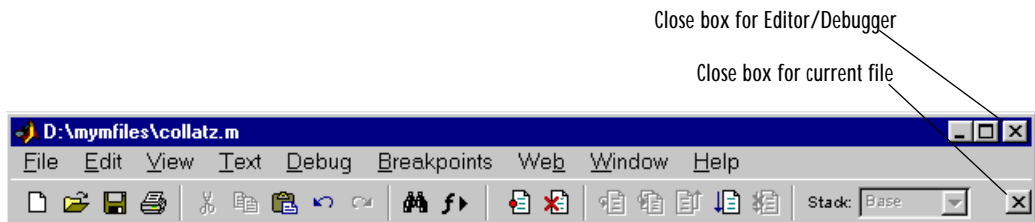

If each file is open in a separate Editor/Debugger window, close all of the files at once using the **Close All** item in the **Window** menu.

When you close the current file and it is the only file open, then the Editor/Debugger closes as well.

When you close a file which has unsaved changes, you are prompted to save the file.

Debugging M-Files

This section introduces general techniques for finding errors, and then illustrates MATLAB debugger features found in the Editor/Debugger and debugging functions using a simple example. It includes these topics:

- “Types of Errors” on page 7-17
- “Finding Errors” on page 7-17
- “Debugging Example – The Collatz Problem” on page 7-18
- “Trial Run for Example” on page 7-20
- “Using Debugging Features” on page 7-22

Types of Errors

Debugging is the process by which you isolate and fix problems with your code. Debugging helps to correct two kinds of errors:

- Syntax errors – For example, misspelling a function name or omitting a parenthesis. “Syntax Highlighting” on page 7-8 helps you identify these problems. MATLAB detects most syntax errors and displays an error message in the Command Window describing the error and showing its line number in the M-file. Position the cursor over the error message and press **Ctrl+Enter** to open the M-file at that line. Use the `pcode` function to check for syntax errors in your M-file without running the M-file.
- Run-time errors – These errors are usually algorithmic in nature. For example, you might modify the wrong variable or perform a calculation incorrectly. Run-time errors are apparent when an M-file produces unexpected results.

Finding Errors

Usually, it's easy to find syntax errors based on MATLAB's error messages. Run-time errors are more difficult to track down because the function's local workspace is lost when the error forces a return to the MATLAB base workspace. Use the following techniques to isolate the cause of run-time errors:

- Remove selected semicolons from the statements in your M-file. Semicolons suppress the display of intermediate calculations in the M-file. By removing

the semicolons, you instruct MATLAB to display these results on your screen as the M-file executes.

- Add keyboard statements to the M-file. Keyboard statements stop M-file execution at the point where they appear and allow you to examine and change the function's local workspace. This mode is indicated by a special prompt, "K>>." Resume function execution by typing return and pressing the **Return** key.
- Comment out the leading function declaration and run the M-file as a script. This makes the intermediate results accessible in the base workspace.
- Use the `depfun` function to see the dependent functions.
- Use the MATLAB Editor/Debugger or debugging functions. They are useful for correcting run-time errors because you can access function workspaces and examine or change the values they contain. You can set and clear *breakpoints*, lines in an M-file at which execution halts. You can change workspace contexts, view the function call stack, and execute the lines in an M-file one by one.

The remainder of this section on debugging M-files describes the use of the Editor/Debugger and debugging function using an example.

Debugging Example – The Collatz Problem

The example debugging session requires you to create two M-files, `collatz.m` and `collatzplot.m`, that produce data for the Collatz problem. For any given positive integer, n , the Collatz function produces a sequence of numbers that always resolves to 1. If n is even, divide it by 2 to get the next integer in the sequence. If n is odd, multiply it by 3 and add 1 to get the next integer in the sequence. Repeat the steps for the next integer in the sequence until the next integer is 1. The number of integers in the sequence varies, depending on the starting value, n .

The Collatz problem is to prove that the Collatz function will resolve to 1 for all positive integers. The M-files for this example are useful for studying the problem. The file `collatz.m` generates the sequence of integers for any given n . The file `collatzplot.m` calculates the number of integers in the sequence for any given n and plots the results. The plot shows patterns that can be further studied.

Following are the results when n is 1, 2, or 3.

n	Sequence	Number of Integers in the Sequence
1	1	1
2	2 1	2
3	3 10 5 16 8 4 2 1	8

M-Files for the Collatz Problem

Following are the two M-files you use for the debugging example. To create these files on your system, open two new M-files. Select and copy the following code from the Help browser and paste it into the M-files. Save and name the files `collatz.m` and `collatzplot.m`. Be sure to save them to your current directory or add to the search path the directory where you save them. One of the files has an embedded error for purposes of illustrating the debugging features.

Code for `collatz.m`.

```
function sequence=collatz(n)
% Collatz problem. Generate a sequence of integers resolving to 1
% For any positive integer, n:
% Divide n by 2 if n is even
% Multiply n by 3 and add 1 if n is odd
% Repeat for the result
% Continue until the result is 1%
sequence = n;
next_value = n;
while next_value > 1
    if rem(next_value,2)==0
        next_value = next_value/2;
    else
        next_value = 3*next_value+1;
    end
    sequence = [sequence, next_value];
end
```

Code for collatzplot.m.

```
function collatzplot(n)
% Plot length of sequence for Collatz problem
% Prepare figure
clf
set(gcf,'DoubleBuffer','on')
set(gca,'XScale','linear')
%
% Determine and plot sequence and sequence length
for m = 1:n
    plot_seq = collatz(m);
    seq_length(m) = length(plot_seq);
    line(m,plot_seq,'Marker','.', 'MarkerSize',9,'Color','blue')
    drawnow
end
```

Trial Run for Example

Try out `collatzplot` to see if it works correctly. Use a simple input value, for example, 3, and compare the results to those shown in the preceding table.

Typing

```
collatzplot(3)
```

produces the plot shown in the following figure.

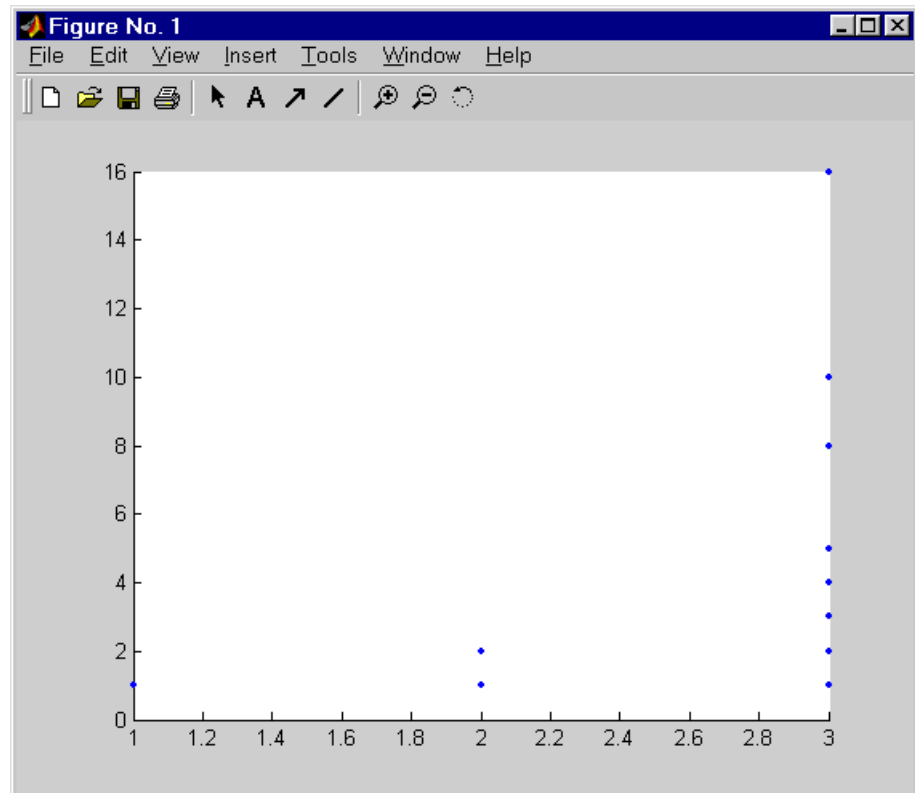

The plot for 1 appears to be correct – when $n = 1$, the Collatz series is 1, and contains one integer. But for $n = 2$ and $n = 3$ it is wrong because there should be only one value plotted for each integer, the length of the sequences, which the preceding table shows to be 2 and 8 respectively. Instead, multiple values are plotted. Use MATLAB debugging features to isolate the problem.

Using Debugging Features

You can debug the M-files using the Editor/Debugger and debugging functions. You can use both methods interchangeably. The example describes both methods.

The debugging process consists of:

- “Preparing for Debugging” on page 7-22
- “Setting Breakpoints” on page 7-22
- “Running an M-File with Breakpoints” on page 7-24
- “Stepping Through an M-File” on page 7-25
- “Examining Values” on page 7-26
- “Correcting Problems and Ending Debugging” on page 7-29

Preparing for Debugging

Do the following to prepare for debugging:

- Open the file – To use the Editor/Debugger for debugging, open it with the file you will run, in this example, `collatzplot.m`.
- Save changes – If you are editing the file, save the changes before you begin debugging. If you try to run and debug a file with unsaved changes, the file is automatically saved before it runs.
- Add the file(s) to a directory on the search path or be sure it is in the current directory – Be sure the file you run and any files it calls are in directories that are on the search path. If all files to be used are in the same directory, you can instead make that directory be the current directory.

Setting Breakpoints

Set breakpoints to pause execution of the function so you can examine values where you think the problem might be. You can only set breakpoints at executable lines in saved files that are in the current directory or in directories on the search path. When you create a new M-file, save it before setting breakpoints. You cannot set breakpoints while MATLAB is busy, for example, running an M-file.

Breakpoints for the Example. It is unclear whether the problem in the example is in `collatzplot` or `collatz`. To start, set breakpoints in `collatzplot.m` at lines 10, 11, and 12. The breakpoint at line 10 allows you to step into `collatz` to see

if the problem might be there. The breakpoints at lines 11 and 12 stop the program where you can examine the interim results.

Setting Breakpoints Using the Editor/Debugger. To set a breakpoint using the Editor/Debugger, click in the breakpoint alley at the line where you want to set the breakpoint. The breakpoint alley is the column to the right of the line number. You can set breakpoints only at lines that are preceded by a - (dash). Lines not preceded by a dash, such as comments, are not executable. Other ways to set a breakpoint are to position the cursor in the line and then click the set/clear breakpoint button  on the toolbar, or select **Set/Clear Breakpoint** from the **Breakpoints** menu or the context menu.

A breakpoint icon appears, as in the following illustration for line 10.

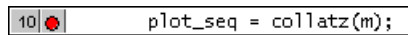

Function Equivalent. To set a breakpoint using the debugging functions, use `dbstop`. For the example, type

```
dbstop in collatzplot at 10
dbstop in collatzplot at 11
dbstop in collatzplot at 12
```

Some useful related functions are:

- `dbtype` – Lists the M-file with line numbers in the Command Window.
- `dbstatus` – Lists breakpoints.

Setting Stops for Conditions. Use the items on the **Breakpoints** menu or the `dbstop` function equivalents to instruct the program to stop when it encounters a problem. For details, see `dbstop`.

- **Stop If Error**, or `dbstop if error`
- **Stop If Warning**, or `dbstop if warning`
- **Stop If NaN Or Inf** (for not-a-number or infinite value), or `dbstop if naninf` or `dbstop if infnan`
- **Stop If All Error**, or `dbstop if all error`

If the File Is Not on the Search Path or In the Current Directory. When you add a breakpoint to a file that is not in a directory on the search path or in the current directory, a dialog box appears presenting you with options that allow you to

add the breakpoint. You can either change the current directory to the directory containing the file, or you can add to the search path the directory containing the file.

Running an M-File with Breakpoints

After setting breakpoints, run the M-file from the Command Window or the Editor/Debugger.

For the example, run `collatzplot` for the simple input value, 3, by typing in the Command Window

```
collatzplot(3)
```

The example, `collatzplot`, requires an input argument and therefore runs only from the Command Window and not from the Editor/Debugger.

Results of Running an M-File Containing Breakpoints. Running the M-file results in the following:

- The prompt in the Command Window changes to `K>>`, indicating that MATLAB is in debug mode.
- The program is paused at the first breakpoint, which in the example is line 10. This means that line 10 will be executed when you continue. The pause is indicated in the Editor/Debugger by the green arrow just to the right of the breakpoint as shown here.

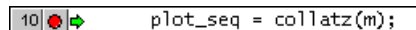

```
10 plot_seq = collatz(m);
```

If you use debugging functions and have the Debugger options preference for **Command Window debugging** checked, the line at which you are paused is displayed in the Command Window. For the example, it would show





```
10 plot_seq = collatz(m);
```

- The function displayed in the **Stack** field on the toolbar changes to reflect the current function. If you use debugging functions, use `dbstack` to view the current call stack. The call stack includes subfunctions as well as called functions.
- If the file you're running is not in the current directory or in a directory on the search path, you're prompted to either add the directory to the path or change the current directory.

Stepping Through an M-File

While in debug mode, you can step through an M-file, pausing at points where you want examine values.

Use the step buttons or the step items in the **Debug** menu of the Editor/Debugger, or use the equivalent functions.

Toolbar Button	Debug Menu Item	Description	Function Equivalent
	Continue	Continue execution of M-file until completion or until another breakpoint is encountered. The menu item says Run or Save and Run if the file is not running.	dbcont
None	Go Until Cursor	Continue execution of M-file until the line where the cursor is positioned. Also available on the context menu.	None
	Step	Execute the current line of the M-file.	dbstep
	Step In	Execute the current line of the M-file and, if the line is a call to another function, step into that function.	dbstep in
	Step Out	After stepping in, runs the rest of the called function or subfunction, leaves the called function, and pauses.	dbstep out

Stepping In. In the example, `collatzplot` is paused at line 10. Use the step-in button or type `dbstep in` in the Command Window to step into `collatz` and walk through that M-file. Stepping in takes you to line 9 of `collatz`.

The pause indicator at line 10 of `collatzplot` changes to a hollow arrow ⇨, indicating that MATLAB control is now in a function called from the main program, which in the example is `collatz`.

In the called function, you can do the same things you can do in the main (calling) function – set breakpoints, run, step through, and examine values.

Stepping Out. In the example, the program is paused at step 9 in `collatz`. Because the problem results are correct for $n = 1$, continue running the program since there is no need to examine values until $n = 2$. The fastest way to run through `collatz` is to step out, which runs the rest of `collatz` and returns to the next line in `collatzplot`, line 11. To step out, use the step-out button or type `dbstep out` in the Command Window.

Examining Values

While the program is paused, you can view the value of any variable currently in the workspace. Use the following methods to examine values:

- “Where to Examine Values” on page 7-26
- “Selecting the Workspace” on page 7-27
- “Viewing Datatips in the Editor/Debugger” on page 7-27
- “Viewing Values in the Command Window” on page 7-28
- “Viewing Values in the Array Editor” on page 7-28
- “Evaluating a Selection” on page 7-28

Many of these methods are used in “Examining Values in the Example” on page 7-28.

Where to Examine Values. When the program is paused, either at a breakpoint or at a line you have stepped to, you can examine values. Examine values when you want to see if a line of code has produced the expected result or not. If the result is as expected, continue running or step to the next line. If the result is not as expected, that line, or a previous line, contains an error.

In the example, because the results for $n = 1$ are correct, there is no need to examine values until $n = 2$. Therefore, continue or step through the first iteration of the loop in `collatzplot` when $m = 1$. When `collatzplot` stops at line 10 the next time (when $m = 2$), step in to the `collatz` function so you can examine values there.

Selecting the Workspace. Variables assigned through the Command Window are considered to be the base workspace. Variables created in each function have their own workspace. To examine a variable, you must first select its workspace. When you run a program, the current workspace is shown in the **Stack** field. To examine values that are part of another function workspace currently running or the base workspace, first select that workspace from the list in the **Stack** field.

Viewing Datatips in the Editor/Debugger. In the Editor/Debugger, position the cursor to the left of a variable. Its current value appears and stays in view until you move the cursor – this is called a datatip. In the example, position the cursor over `n` in `collatz` – the datatip shows that `n = 2`, as expected. Note that the **Stack** shows `collatz` as the current function.

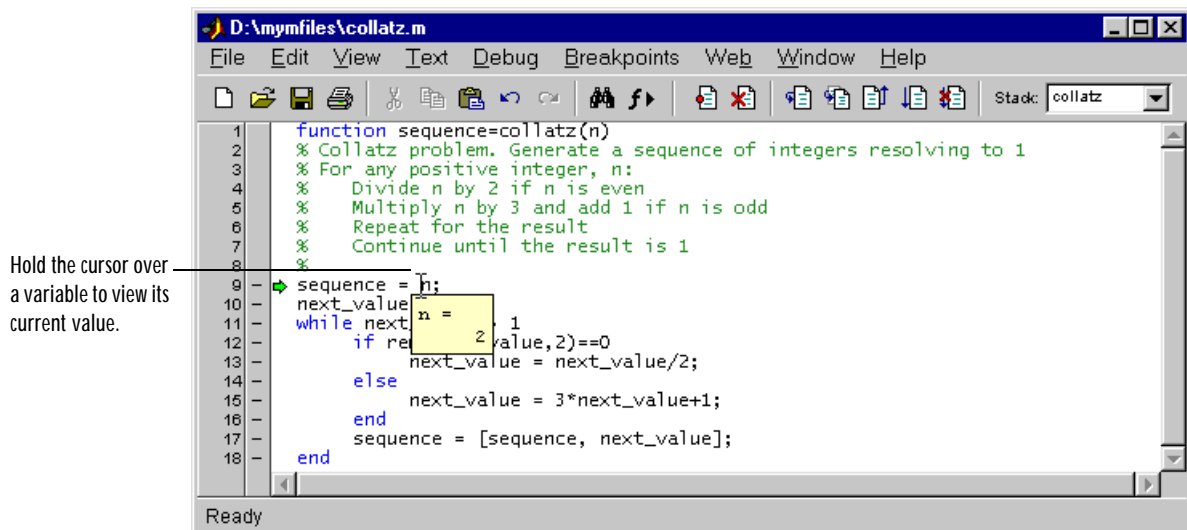

Viewing Values in the Command Window. Type a variable name in the Command Window and MATLAB displays its current value. To see the variables currently in the workspace, use `who`. To see the value of `n` for the example, type

```
n
```

and MATLAB returns the expected result

```
n =
     2
```

Viewing Values in the Array Editor. You can view the value of any variable in the Array Editor. To view the current variables, open the Workspace browser. In the Workspace browser, double-click a variable – the Array Editor opens, displaying the value for that variable. You can also open the Array Editor for a variable using `openvar`.

To see the value of `n` in the Array Editor for the example, type

```
openvar n
```

and the Array Editor opens, showing that `n = 2` as expected.

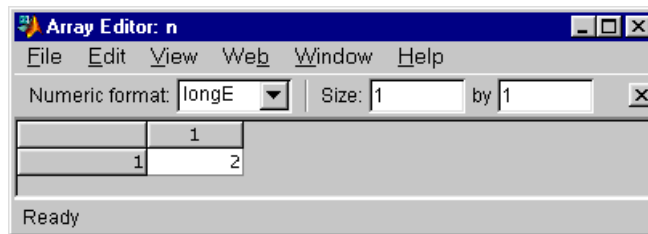

Evaluating a Selection. Select a variable or equation in an M-file in the Editor/Debugger. Right-click and select **Evaluate Selection** from the context menu. MATLAB displays the value of the variable or equation in the Command Window. You cannot evaluate a selection while MATLAB is busy, for example, running an M-file.

Examining Values in the Example. In `collatz`, use the step button or the function `dbstep`. The program advances to line 10, where there is no need to examine values. Continue stepping until line 13.

When you step again, the pause indicator jumps to line 17, just after the `if` loop, as expected, given the code in line 13 for `next_value = 2`. When you step

again, you can check the value of `sequence` in line 17 and see that it is `2 1` as expected for $n = 2$. Stepping again takes you from line 17 to line 10. Because `next_value` is 1, the while loop ends. The pause indicator is at line 10 and appears as a green down arrow . This indicates that processing in the called function is complete and program control will return to the calling program, in this case, `collatzplot` line 10.

In `collatzplot`, step again to advance to line 11, then line 12. The variable `sequence_length` in line 11 is a vector with the elements `1 2`, which is correct.

Finally, step again to advance to line 13. Examining the values in line 12, $m = 2$ as expected, but the second variable, `plot_seq`, has two values, where only one value is expected. While `plot_seq` has the value expected, `2 1`, it is the incorrect variable for plotting. Instead, the variable `seq_length` should be plotted.

Correcting Problems and Ending Debugging

These are some of the ways to correct problems and end the debugging session:

- “Changing Values and Checking Results” on page 7-29
- “Ending Debugging” on page 7-30
- “Clearing Breakpoints” on page 7-30
- “Correcting an M-File” on page 7-31

Many of these features are used in “Completing the Example” on page 7-31.

Changing Values and Checking Results. While debugging, you can change the value of a variable in the current workspace to see if the new value produces expected results. While the program is paused, assign a new value to the variable in the Command Window or in the Array Editor. Then continue running or stepping through the program. If the new value does not produce the expected results, the program has a different or another problem.

Ending Debugging. After identifying a problem, end the debugging session. You must end a debugging session if you want to change an M-file to correct a problem or if you want to run other functions in MATLAB.

Note Always quit debug mode before editing an M-file. If you edit an M-file while in debug mode, you can get unexpected results when you run the file.

To end debugging, click the exit debug mode icon , or select **Exit Debug Mode** from the **Debug** menu.

You can instead use the function `dbquit` to end debugging.

After quitting debugging, the pause indicators in the Editor/Debugger display no longer appear, and the normal prompt `>>` now appears in the Command Window instead of the debugging prompt, `K>>`. You can no longer access the call stack.

Clearing Breakpoints. Breakpoints remain in a file until you clear them. Clear the breakpoints if you want the program to run uninterrupted, such as after identifying and correcting a problem.

To clear a breakpoint in the Editor/Debugger, click on the breakpoint icon for a line, or select **Set/Clear Breakpoint** from the **Breakpoints** or context menu. The breakpoint for that line is cleared.

To clear all breakpoints in all files, select **Clear All Breakpoints** from the **Breakpoints** menu, or click the  equivalent button on the toolbar.

The function that clears breakpoints is `dbclean`. To clear all breakpoints, use `dbclean all`. For the example, clear all of the breakpoints in `collatzplot` by typing

```
dbclean all in collatzplot
```

Breakpoints are automatically cleared when you:

- End the MATLAB session
- Clear the M-file using `clear name` or `clear all`
- Edit the file if the changes impact line numbering
- Edit the file while in debug mode (although this does not always clear breakpoints)

Correcting an M-File. To correct a problem in an M-file:

- 1 Quit debugging.

Do not make changes to an M-file while MATLAB is in debug mode. It could produce unexpected debugging results when you run the M-file.

- 2 Clear all the breakpoints in the file.

The breakpoints become unreliable once the M-file is edited. The breakpoints will produce unexpected debugging results when you run the file.

- 3 Make changes to the M-file.
- 4 Save the M-file.
- 5 Set breakpoints, if desired.
- 6 Run the M-file again to be sure it produces the expected results.

Completing the Example. To correct the problem in the example, do the following:

- 1 End the debugging session. One way to do this is to select **Exit Debug Mode** from the **Debug** menu.
- 2 Clear the breakpoints in `collatzplot.m`. One way to do this is by typing
`dbclear all` in `collatzplot`
in the Command Window.

- 3 In `collatzplot.m` line 12, change the string `plot_seq` to `seq_length(m)` and save the file.
- 4 Run `collatzplot` for $n = 3$ by typing
`collatzplot(3)`
in the Command Window.
- 5 Verify the result. The figure shows that the length of the Collatz series is 1 when $n = 1$, 2 when $n = 2$, and 8 when $n = 3$, as expected.

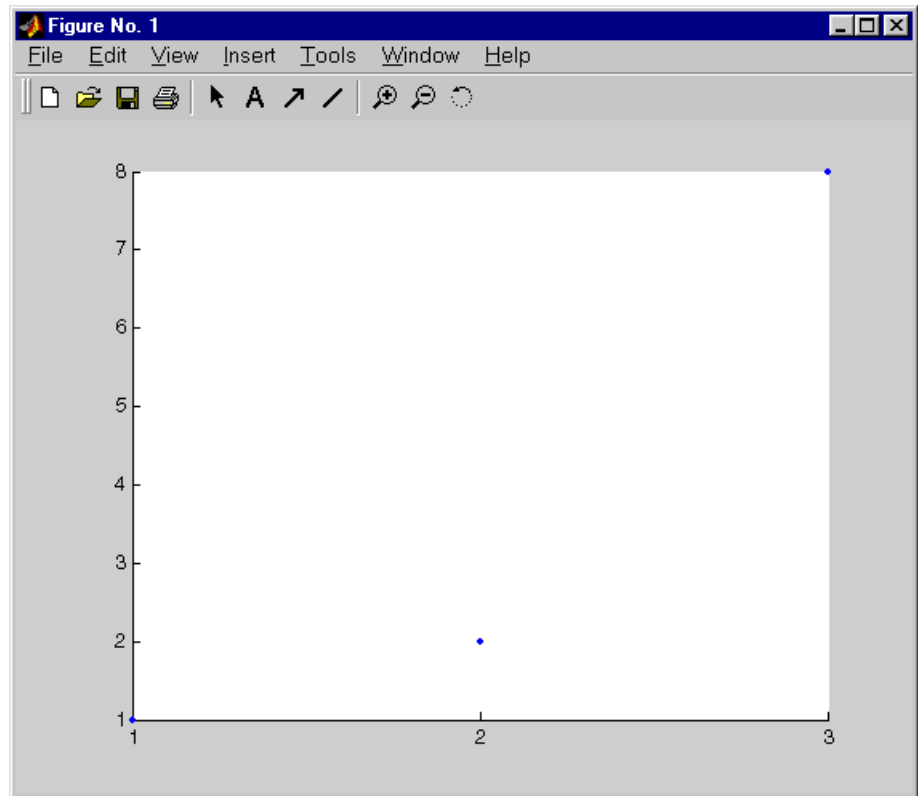

- 6 Test the function for a slightly larger value of n , such as 6, to be sure the results are still accurate. To make it easier to verify `collatzplot` for $n = 6$ as well as the results for `collatz`, add this line at the end of `collatz.m`

```
sequence
```

which displays the series in the Command Window.

Then run `collatzplot` for $n = 6$ by typing

```
collatzplot(6)
```

- 7 To make debugging easier, you ran `collatzplot` for a small value of n . Now that you know it works correctly, run `collatzplot` for a larger value to produce more interesting results. Before doing so, you might want to suppress output for the line you just added in step 6, line 18 of `collatz.m`, by adding a semicolon to the end of the line so it appears as

```
sequence;
```

Then run

```
collatzplot(500)
```

The following figure shows the lengths of the Collatz series for $n = 1$ through $n = 500$.

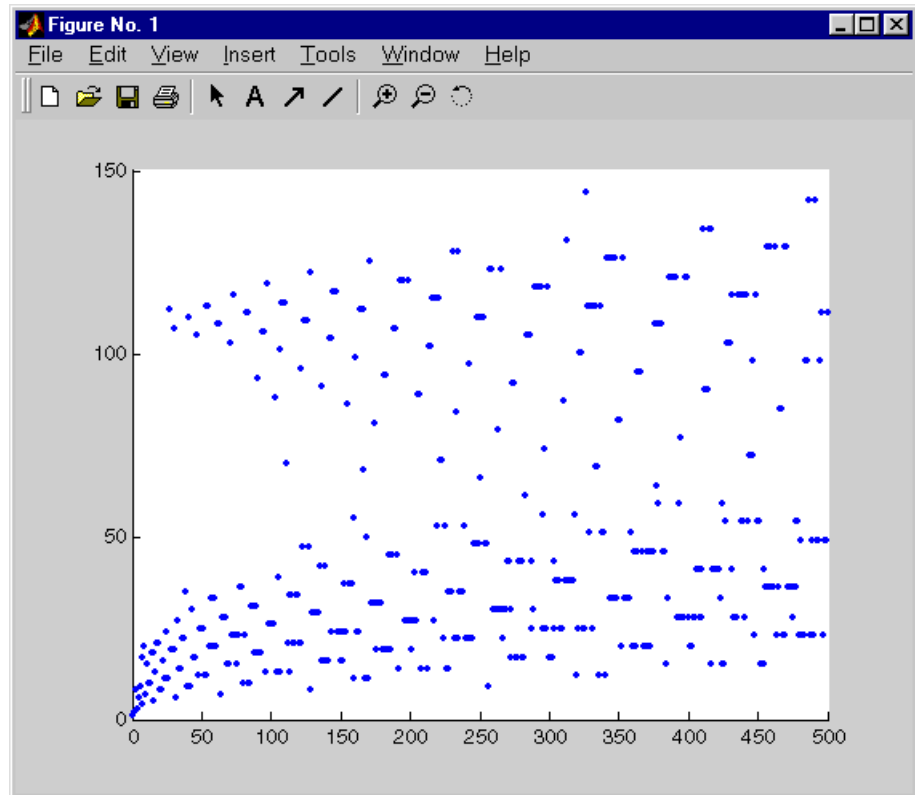

Preferences for the Editor/Debugger

Using preferences, you can specify the default behavior for various aspects of the Editor/Debugger.

To set preferences for the Editor/Debugger, select **Preferences** from the **File** menu in the Editor/Debugger. The **Preferences** dialog box opens showing **Editor/Debugger Preferences**.

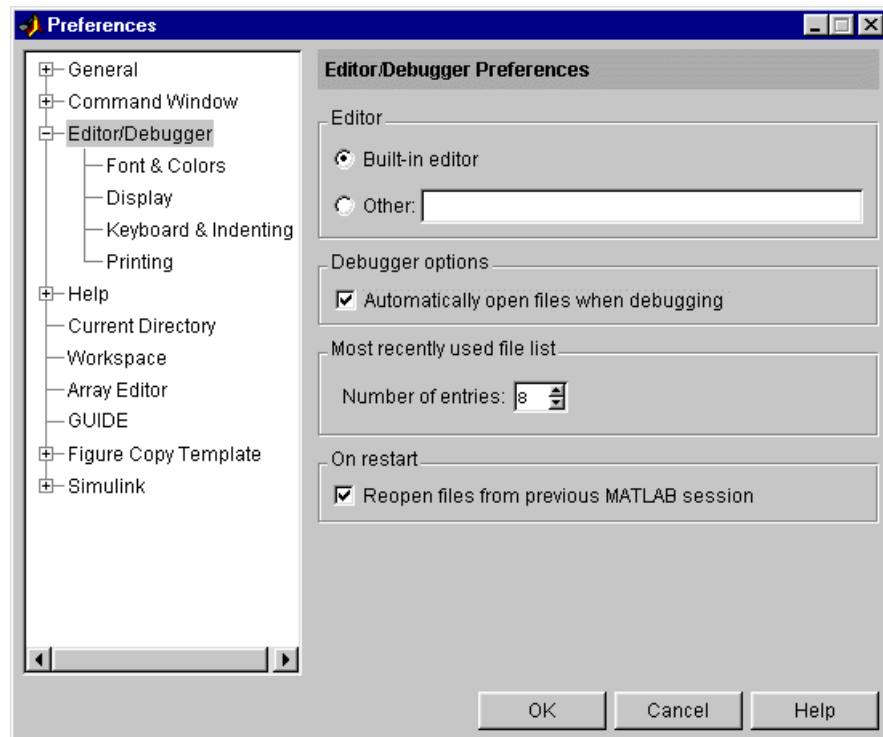

You can specify the following Editor/Debugger preferences:

- “General Preferences for the Editor/Debugger” on page 7-36 (on the first panel, including the **Editor** preference)
- “Font & Colors Preferences for the Editor/Debugger” on page 7-37
- “Display Preferences for the Editor/Debugger” on page 7-38
- “Keyboard and Indenting Preferences for the Editor/Debugger” on page 7-40
- “Printing Preferences for the Editor/Debugger” on page 7-42

General Preferences for the Editor/Debugger

When you first access preferences for the Editor/Debugger, you can specify the general preferences described here.

Editor

By default, the **Built-in editor** option is selected, meaning that MATLAB uses its own Editor/Debugger.

To specify a text editor other than MATLAB’s Editor, such as Emacs or vi, to be used when you open an M-file from within MATLAB, select **Other**. In the **Other** field, type the path to the editor application you want to use.

For example, specify `C:\Applications\Emacs.exe` in the **Other** field, and then open a file using **Open** from the **File** menu the MATLAB desktop. The file opens in Emacs instead of in the MATLAB Editor/Debugger.

Debugger options

By default, the item **Automatically open files when debugging** is checked. The result is that when you run an M-file containing breakpoints, the MATLAB Editor/Debugger opens when it encounters a breakpoint.

If you use debugging functions, you might want to uncheck the item so that the Editor/Debugger does *not* open when a breakpoint is encountered.

Most recently used file list

Use this preference to specify the number of files that appear in the list of most recently used files in the **File** menu.

On restart

To start MATLAB and automatically open the files that were open when you last shut down MATLAB, check the item **Reopen files from previous MATLAB session**. If the item is unchecked and you close MATLAB when there are files open in the Editor/Debugger, the next time you start MATLAB, the Editor/Debugger is not opened upon startup.

Font & Colors Preferences for the Editor/Debugger

Use **Font & Colors** preferences to specify the font and colors used in files in the Editor/Debugger.

Font

Editor/Debugger font preferences specify the characteristics of the font used in files in the Editor/Debugger. Select **Use desktop font** if you want the font in the files to be the same as that specified under **General - Font & Colors**. If you want the font for Editor/Debugger files to be different, select **Use custom font** and specify the font characteristics:

- Type, for example, Lucida Console
- Style, for example, Plain
- Size in points, for example, 12 points

After you make a selection, the **Sample** area shows how the font will look.

You can specify different font characteristics for printing files from the Editor – see “Printing Preferences for the Editor/Debugger” on page 7-42.

Colors

Specify the colors used in files in the Editor/Debugger:

- **Text color** – The color of nonspecial text; special text uses colors specified for **Syntax highlighting**.
- **Background color** – The color of background in the window.
- **Syntax highlighting** – The colors to use to highlight syntax. If checked, click **Set Colors** to specify them. For a description of syntax highlighting, see “Syntax Highlighting” on page 3-5.

Display Preferences for the Editor/Debugger

Use **Display** preferences to specify how the Editor/Debugger window should look.

Opening files in editor

This preference controls how files are arranged when you open them in the Editor/Debugger. When you change this preference, it applies to files you open after making the change. Currently opened files are not rearranged to match the preference.

Check **Single window contains all files (tabbed style)** to have a single Editor/Debugger window for all open files, as shown in the following illustration. Click the tab for a file to make it the current file.

Files are tabbed within one window.

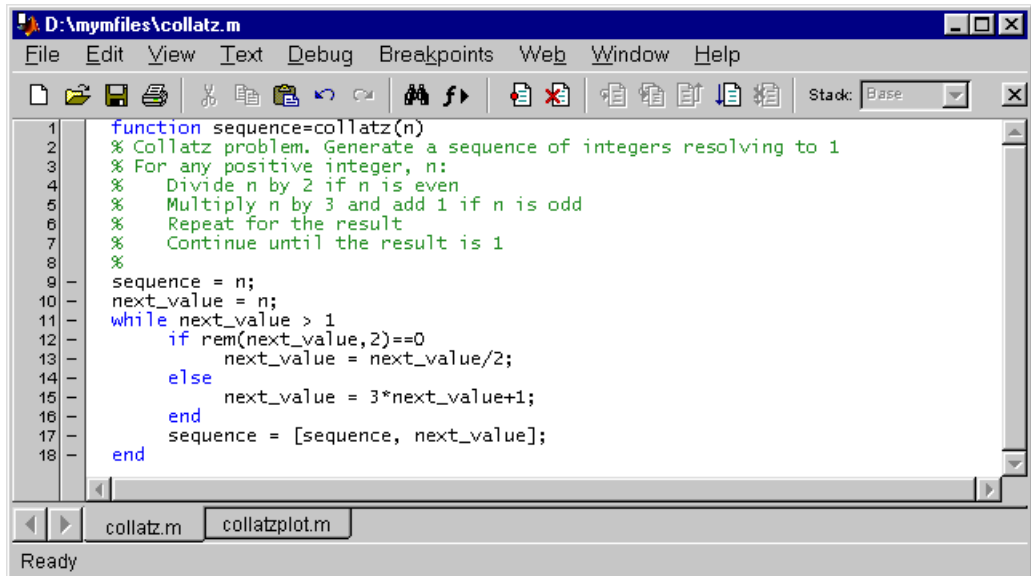

Check **Each file is displayed in its own window** to have a separate Editor/Debugger window for each open file, as shown in the following illustration.

Each file is
in its own
window.

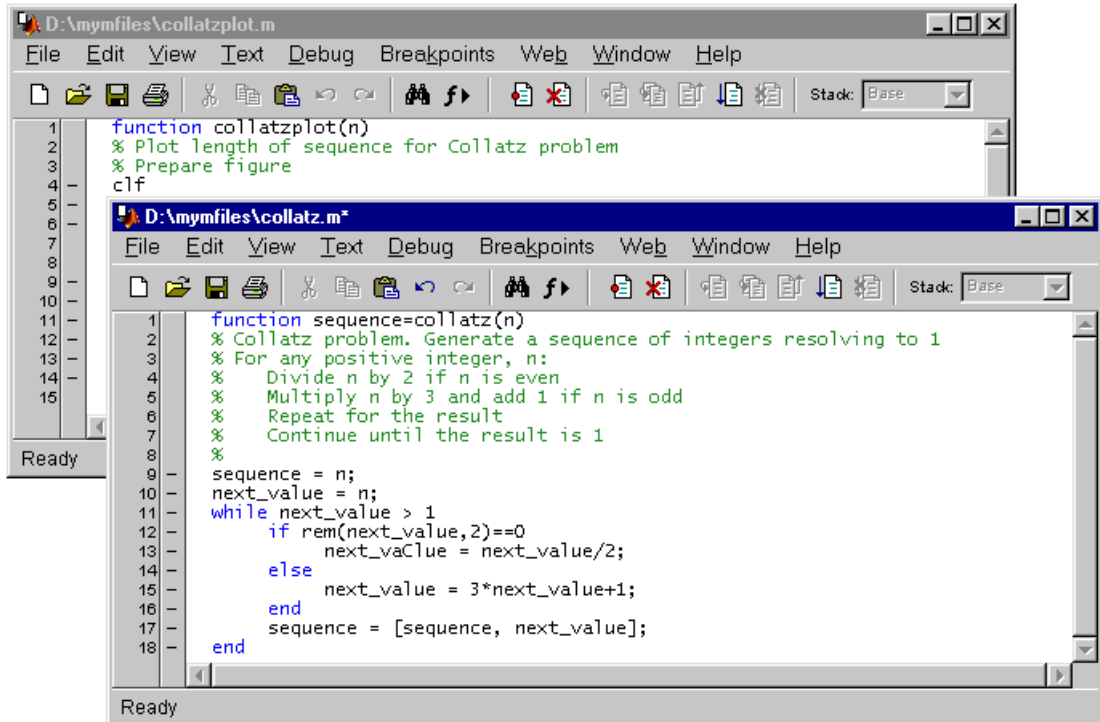

Display

Use display options to specify what is shown and what is hidden in the Editor/Debugger.

Show toolbar. Check this item to display the toolbar. Uncheck it to hide the toolbar.

Show line numbers. Check this item to show line numbers. They appear along the left side of the window. When you uncheck this item, line numbers aren't shown.

Enable datatips in edit mode. Check this item to see datatips while in edit mode. Datatips are always enabled in debug mode.

Prompt

When you type `edit filename` and `filename` does not exist, MATLAB displays a prompt asking if you want to create a new file named `filename.m`. If you do not want to see this prompt, uncheck the preference **Show dialog prompt when editing files that do not exist**. Then, the next time you type `edit filename`, the file will be created without first prompting you.

If you do not generally use the `edit` command to create new files, then you might want to check the box to show the prompt. This alerts you to the possibility that you mistyped the filename you want to open.

Keyboard and Indenting Preferences for the Editor/Debugger

Use keyboard preferences to specify the key binding conventions MATLAB should follow. Use indenting preferences to specify how the Editor/Debugger indents lines.

Key bindings

Select **Windows** or **Emacs** depending on which convention you want the Editor/Debugger to follow for accelerators and shortcuts. The accelerators seen on the menus change after you change this option.

For example, when you select Windows key bindings, the shortcut to paste a selection is **Ctrl+V**. When you select Emacs key bindings, the shortcut to paste a selection is **Ctrl+Y**. You can see the accelerator on the **Edit** menu for the **Paste** item.

M-file indenting for Enter key

Select the style of indenting you want the Editor/Debugger to use when you press the **Enter** key. Examples follow, illustrating the different styles.

- **No indent** – No lines are indented. Use this if you want lines to be aligned on the left or want to insert line indents manually.
- **Block indent** – Indents a line the same amount as the line above it.
- **Smart indent** – Automatically indents lines that start with keyword functions or that follow certain keyword functions. Smart indenting can help you to follow the code sequence.

The indenting style only applies to lines you enter after changing the preference; it does not affect the indenting of existing lines. To change the indenting for existing lines, use the **Text** menu entries for “Indenting” on page 7-9.

For any indenting style, you can manually insert tabs at the start of a line.

Example of No Indent Without Tabs.

```
sequence = n
next_value = n;
while next_value > 1
if rem(next_value,2)==0
next_value = next_value/2;
else
next_value = 3*next_value+1;
end
sequence = [sequence, next_value]
end
```

Created using **No indent** preference.
Did not manually insert any tabs.

Example of No Indent with Tabs.

```
sequence = n
next_value = n;
while next_value > 1
    if rem(next_value,2)==0
        next_value = next_value/2;
    else
        next_value = 3*next_value+1;
    end
    sequence = [sequence, next_value]
end
```

Created using **No indent** preference.
Created indentation by manually inserting a tab
before each indented line.

Example of Block Indent.

```
sequence = n
next_value = n;
while next_value > 1
    if rem(next_value,2)==0
        next_value = next_value/2;
    else
        next_value = 3*next_value+1;
    end
    sequence = [sequence, next_value]
end
```

Created using **Block indent** preference.
Inserted a tab before the **if** statement.
Subsequent lines automatically indented one tab.

Example of Smart Indent.

```
sequence = n
next_value = n;
while next_value > 1
  if rem(next_value,2)==0
    next_value = next_value/2;
  else
    next_value = 3*next_value+1;
  end
  sequence = [sequence, next_value]
end
```

Created using **Smart indent** preference.
Did not manually insert any tabs.
Indented lines were automatically indented.

Indent

Indent size. Specify the indent size for smart indenting.

Emacs-style tab key smart indenting. This indenting convention is based on the style used by the Emacs editor. When you select the style, lines are not automatically indented. To indent a line(s) according to smart indenting practices, you can position the cursor in that line or select a group of lines and then press the **Tab** key.

Tab

Tab size. Specify the amount of space inserted when you press the **Tab** key. When you change the **Tab size**, it changes the tab space for existing lines in that file.

Tab key inserts spaces. Check this item if you want a series of spaces to be inserted when you press the **Tab** key. If the item is unchecked, a tab acts as one space whose length is determined by **Tab size**.

Printing Preferences for the Editor/Debugger

Use printing preferences to specify how printed M-files will look.

Syntax highlighting

This preference specifies how highlighted syntax is printed. The options are:

- **Print as black and white text**
- **Print as colored text**
- **Print as styled text** – Prints in black and white. Comments are italicized and keywords are bold.

Print options

- Check **Print header** to include a header on the printed page that lists the full pathname for the file, page numbers, and the date and time it is printed.
- Check **Print line numbers** to include line numbers when printing files.

Font

Use this preference to specify font characteristics for printed M-files. This is especially useful on Windows platforms because a given font size is displayed slightly smaller than the actual size, but is printed at the actual size. Therefore the font in the printed output might look larger than you expected.

To print documents using the same font characteristics as specified for the Editor/Debugger (see “Font & Colors Preferences for the Editor/Debugger” on page 7-37), select **Use editor font**.

To print documents with different font characteristics than those specified for the Editor/Debugger, select **Use custom font**. After selecting this option, specify the font characteristics:

- Type, for example, Lucida Console
- Style, for example, Plain
- Size in points, for example, 12 points

Improving M-File Performance – the Profiler

What Is Profiling?	8-3
Using the Profiler	8-4
The profile Function	8-4
An Example Using the Profiler	8-6
Viewing Profiler Results	8-7
Viewing Profile Reports	8-7
Profile Plot	8-12
Saving Profile Reports	8-13

One way to improve the performance of your M-files is to profile them. MATLAB provides an M-file profiler that lets you see how much computation time each line of an M-file uses.

This section on profiling covers the following topics:

- “What Is Profiling?” on page 8-3
- “Using the Profiler” on page 8-4, including “The profile Function” and “An Example Using the Profiler”
- “Viewing Profiler Results” on page 8-7

There are numerous other techniques for improving the performance of your M-files. For a list of these types of functions, see Performance Tools and Techniques.

What Is Profiling?

Profiling is a way to measure where a program spends its time. Measuring is a much better method than guessing where the most execution time is spent. You probably deal with obvious speed issues at design time and can then discover unanticipated effects through measurement. One key to effective coding is to create an original implementation that is as simple as possible and then use a profiler to identify bottlenecks if speed is an issue. Premature optimization often increases code complexity unnecessarily without providing a real gain in performance.

Use the profiler to identify functions that are consuming the most time, then determine why you are calling them and look for ways to minimize their use. It is often helpful to decide whether the number of times a particular function is called is reasonable. Because programs often have several layers, your code may not explicitly call the most expensive functions. Rather, functions within your code may be calling other time-consuming functions that can be several layers down in the code. In this case it's important to determine which of your functions are responsible for such calls.

The profiler often helps to uncover problems that you can solve by:

- Avoiding unnecessary computation, which can arise from oversight.
- Changing your algorithm to avoid costly functions.
- Avoiding recomputation by storing results for future use.

When you reach the point where most of the time is spent on calls to a small number of built-in functions, you have probably optimized the code as much as you can expect.

Using the Profiler

Use the `profile` function to generate and view statistics.

- 1 Start the profiler by typing `profile on` in the Command Window. Specify any options you want to use.
- 2 Execute your M-file.

The profiler counts how many seconds each line in the M-files use. The profiler works cumulatively, that is, adding to the count for each M-file you execute until you clear the statistics.

- 3 Use `profile report` to display the statistics gathered in an HTML-formatted report in your system's default Web browser.

The `profile` Function

Here is a summary of the main forms of `profile`. For details about these and other options, type `doc profile`.

Syntax	Option	Description
<code>profile on</code>		Starts the profiler, clearing previously recorded statistics.
	<code>-detail level</code>	Specifies the level of function to be profiled.
	<code>-history</code>	Specifies that the exact sequence of function calls is to be recorded.
<code>profile off</code>		Suspends the profiler.
<code>profile report</code>		Suspends the profiler, generates a profile report in HTML format, and displays the report in your system's default Web browser.
	<code>basename</code>	Saves the report in the file <code>basename</code> in the current directory.

Syntax	Option	Description (Continued)
<code>profile plot</code>		Suspends the profiler and displays in a figure window a bar graph of the functions using the most execution time.
<code>profile resume</code>		Restarts the profiler without clearing previously recorded statistics.
<code>profile clear</code>		Clears the statistics recorded by the profiler.
<code>s = profile('status')</code>		Displays a structure containing the current profiler status.
<code>stats = profile('info')</code>		Suspends the profiler and displays a structure containing profiler results.

Some people use `profile` simply to see the child functions; see also `depfun` for that purpose.

An Example Using the Profiler

This example demonstrates how to run the profiler.

- 1 To start the profiler, type in the Command Window

```
profile on -detail builtin -history
```

The `-detail builtin` option instructs the profiler to gather statistics for built-in functions, in addition to the default M-functions, M-subfunctions, and MEX-functions.

The `-history` option instructs the profiler to track the exact sequence of entry and exit calls.

- 2 Execute an M-file. This example runs the Lotka-Volterra predator-prey population model. For more information about this model, type `lotkadem` to run a demonstration.

```
[t,y] = ode23('lotka',[0 2],[20;20]);
```

- 3 Generate the profile report and save the results to the file `lotkaprof`.

```
profile report lotkaprof
```

This suspends the profiler, displays the profile report in your system's default Web browser, and saves the results. See “Viewing Profiler Results” on page 8-7 for more information.

- 4 Restart the profiler, without clearing the existing statistics.

```
profile resume
```

The profiler is now ready to continue gathering statistics for any more M-files you run. It will add these new statistics to those generated in the previous steps.

- 5 Stop the profiler when you are finished gathering statistics.

```
profile off
```

Viewing Profiler Results

There are two main ways to view the profiler results:

- “Viewing Profile Reports” on page 8-7
- “Profile Plot” on page 8-12

To save results, see “Saving Profile Reports” on page 8-13.

Viewing Profile Reports

To display profiler results, type

```
profile report
```

This suspends the profiler and produces three reports:

- “Summary Profile Report” on page 8-7
- “Function Details Profile Report” on page 8-10
- “Function Call History Profile Report” on page 8-11

The summary report appears in your system’s default Web browser. Use the links at the top of the report page to see the other reports.

Summary Profile Report

The summary report presents statistics about the overall execution and provides summary statistics for each function called. Values reported include:

- **Number of functions** – The numbers of built-in functions, M-functions, and M-subfunctions are reported.
- **Clock precision** – The precision of the profiler’s time measurement. When Time for a function is 0, it is actually a positive value, but smaller than the profiler can detect given the clock precision.
- **Time columns** – The total time spent in a function, including all child functions called. Because the time for a function includes time spent on child functions, the times do not add up to the **Total recorded time** and the percentages add up to more than 100%.
- **Self time columns** – The total time spent in a function, *not* including time for any child functions called. Adding the **Self time** values for all functions listed

equals the **Total recorded time**. The **Self time** percentages for all functions add up to approximately 100%.

Note that the profiler itself uses some time, which is included in the profiler results.

Following is the summary report for the Lotka-Volterra model described in “An Example Using the Profiler” on page 8-6.

View summary report (shown in this illustration). View details for all functions. View sequence of function calls.

Total time profiler was recording.

Follow link to view details for each function.

Report includes built-in functions because -detail builtin option was used.

Name	Time	Calls	Time/call	Self time	Location
ode23	0.11 100.0%	1	0.1100	0.03 27.3%	D:\matlab
odearguments	0.08 72.7%	1	0.0800	0.06 54.5%	D:\matlab
lotka	0.01 9.1%	34	0.0003	0.01 9.1%	D:\matlab
feval	0.01 9.1%	34	0.0003	0.00 0.0%	Builtin-functio
isfield	0.01 9.1%	11	0.0009	0.01 9.1%	D:\matlab

Time per function includes time spent in child functions.

Self time does NOT include time spent in child functions.

Function Details Profile Report

The function details report provides statistics for the parent and child functions of a function, and reports the line numbers on which the most time was spent. Following is detail report for the `lotka` function, which is one of the functions called in “An Example Using the Profiler” on page 8-6.

MATLAB Profiler Report - Netscape

File Edit View Go Communicator Help

[Summary](#) | [Function Details](#) | [Function Call History](#)

lotka
[D:\matlabr12\toolbox\matlab\demos\lotka.m](#)
 Time: 0.01 s (9.1%)
 Calls: 34
 Self time: 0.01 s (9.1%)

Function:	Time	Calls	Time/call
lotka	0.01	34	0.0003

Parent functions:

feval	34
-----------------------	----

Child functions:

diag	0.00	0.0%	34	0.0000
horzcat	0.00	0.0%	34	0.0000

100% of the total time in this function was spent on the following lines:

```

6:
0.01 100% 7: yp = diag([1 - .01*y(2), -1 + .02*y(1)])'
```

Document Done

Time in seconds

Percentage of the
function's time
spent on that line

Line number

Function Call History Profile Report

The function call history displays the exact sequence of functions called. To view this report, you must have started the profiler using the `-history` option.

```
profile on -history
```

The profiler records up to 10,000 function entry and exit events. For more than 10,000 events, the profiler continues to record other profile statistics, but not the sequence of calls. Following is the history report generated from “An Example Using the Profiler” on page 8-6.

Exact sequence
of calls

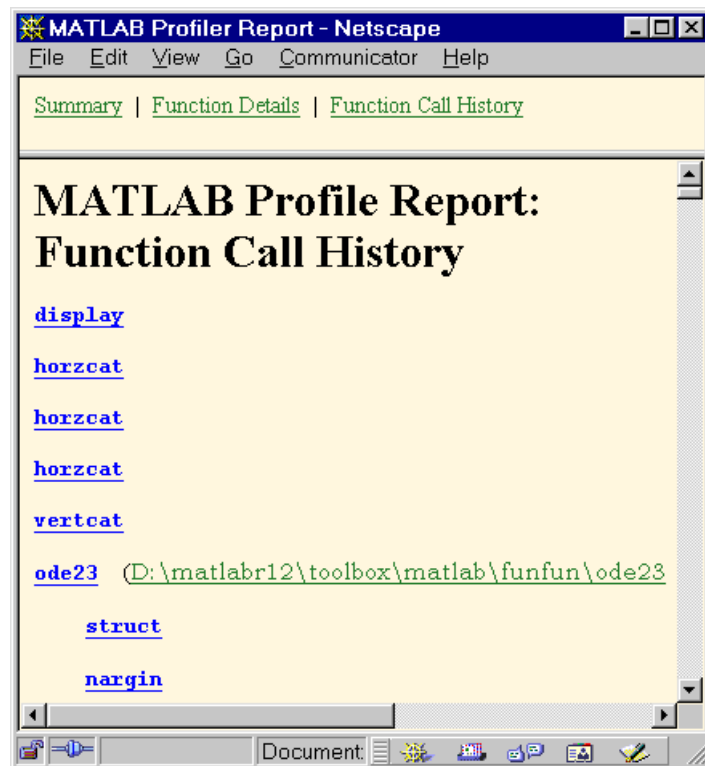

Profile Plot

To view a bar graph for the functions using the most execution time, type
`profile plot`

This suspends the profiler. The bar graph appears in a figure window. Following is the bar graph generated from “An Example Using the Profiler” on page 8-6.

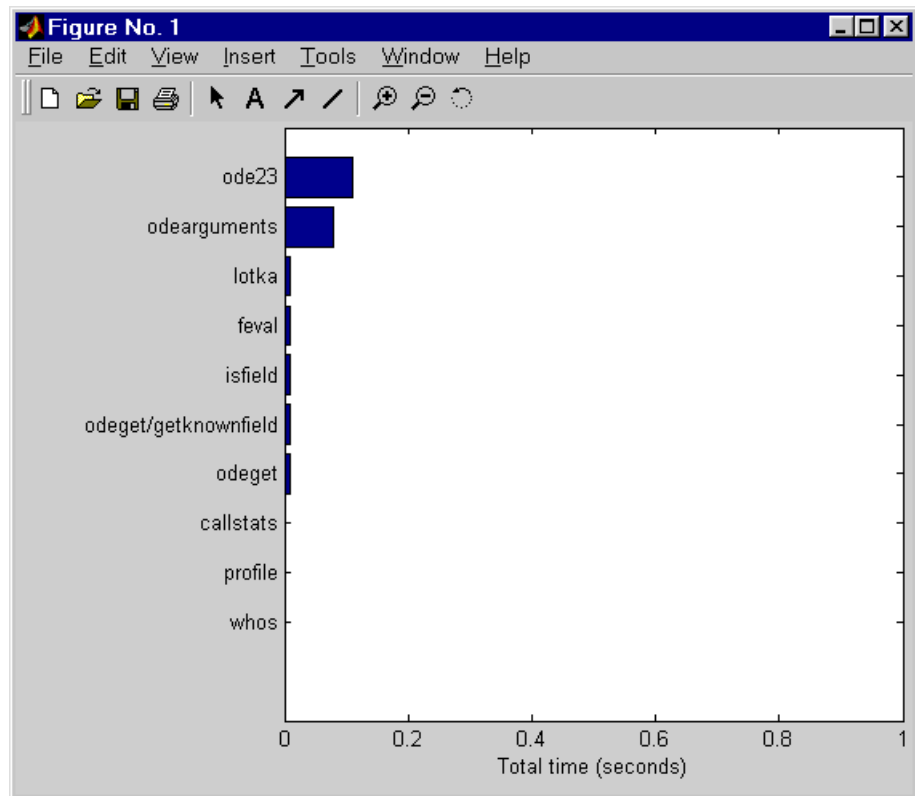

Saving Profile Reports

When you generate the profile report, use the option to save it. For example,

```
profile report basename
```

saves the profile report to the file `basename` in the current directory. Later you can view the saved results using a Web browser.

Another way to save results is with the `info = profile` function, which displays a structure containing the profiler results. Save this structure so that later you can generate and view the profile report using `profreport(info)`.

Example Using Structure of Profiler Results

The profiler results are stored in a structure that you can view or access. This example illustrates how you can view the results.

- 1 Run the profiler for code that computes the Lotka-Volterra predator-prey population model.

```
profile on -detail builtin -history  
[t,y] = ode23('lotka',[0 2],[20;20]);
```

- 2 To view the structure containing profiler results, type

```
stats = profile('info')
```

MATLAB returns

```
stats =  
    FunctionTable: [41x1 struct]  
    FunctionHistory: [2x826 double]  
    ClockPrecision: 0.0100  
    Name: 'MATLAB'
```

- 3 You can view and access the contents of the structure. For example, type
`stats.FunctionTable`

MATLAB displays the FunctionTable structure.

```
ans =  
41x1 struct array with fields:  
    FunctionName  
    FileName  
    Type  
    NumCalls  
    TotalTime  
    TotalRecursiveTime  
    Children  
    Parents  
    ExecutedLines
```

- 4** To view the contents of an element in the FunctionTable structure, type, for example,

```
stats.FunctionTable(2)
```

MATLAB returns the second element in the structure.

```
ans =  
    FunctionName: 'horzcat'  
    FileName: ''  
    Type: 'Builtin-function'  
    NumCalls: 43  
    TotalTime: 0.0100  
    TotalRecursiveTime: 0.0100  
    Children: [0x1 struct]  
    Parents: [2x1 struct]  
    ExecutedLines: [0x3 double]
```

- 5** Save the results.

```
save profstats
```

- 6** In a later session, to generate the profiler report using the saved results, type

```
load profstats  
profreport(stats)
```

MATLAB displays the profile report.

Interfacing with Source Control Systems

Process of Interfacing to an SCS	9-3
Viewing or Selecting the Source Control System	9-4
Function Alternative for Viewing the SCS	9-5
Setting Up the Source Control System	9-6
For SourceSafe Only – Mirroring MATLAB Hierarchy	9-6
For ClearCase on UNIX Only – Set a View and Check Out a Directory	9-6
Checking Files into the Source Control System	9-7
Function Alternative for Checking In Files	9-8
Checking Files Out of the SCS	9-9
Function Alternative for Checking Out Files	9-10
Undoing the Check-Out	9-10

If you use a source control system (SCS) to manage your files, you can check M-files and Simulink and Stateflow files into and out of the source control system from within MATLAB, Simulink, and Stateflow.

MATLAB, Simulink, and Stateflow do not perform source control functions, but only provide an interface to your own source control system. This means, for example, that you can open a file in the MATLAB Editor and modify it without checking it out. However, the file will remain read-only so that you cannot accidentally overwrite the source control version of the file.

Four popular source control systems are supported, as well as a custom option:

- ClearCase from Rational Software
- PVCS from Merant
- RCS
- Visual SourceSafe from Microsoft
- Custom option – Allows you to build your own interface if you use a different source control system

Process of Interfacing to an SCS

You can interface to your source control system by using menus if you prefer a graphical user interface, or by using functions if you prefer to use the Command Window. There are some options you can perform using the functions that are not available with the menus – these are noted in the instructions.

Create M-files, Simulink files, or Stateflow files as you normally would and save the files. Then follow these steps to use MATLAB, Simulink, or Stateflow to interface with your source control system.

	Steps	Instructions
1	Select the source control system to use.	See “Viewing or Selecting the Source Control System” on page 9-4.
2	Set up your source control system to correctly include the files. This is only required for some source control systems.	“For SourceSafe Only – Mirroring MATLAB Hierarchy” on page 9-6 “For ClearCase on UNIX Only – Set a View and Check Out a Directory” on page 9-6
3	Check the files into the source control system. Note that for some source control systems, you must check out the files before you can check them in.	“Checking Files into the Source Control System” on page 9-7
4	Next time you want to modify the files, open them in the MATLAB Editor, Simulink, or Stateflow, and check them out.	“Checking Files Out of the SCS” on page 9-9
5	Undo a check-out if you want the files to remain checked in, without any of the changes you made since you checked them out.	“Undoing the Check-Out” on page 9-10

Viewing or Selecting the Source Control System

Specify the source control system for MATLAB to interface with:

- 1 From the MATLAB desktop, select **Preferences** from the **File** menu. You can also select this from the Simulink or Stateflow model or library windows.

The **Preferences** dialog box opens.

- 2 Click the + for **General** and then select **Source Control**.

The currently selected system is shown. The default selection is None.

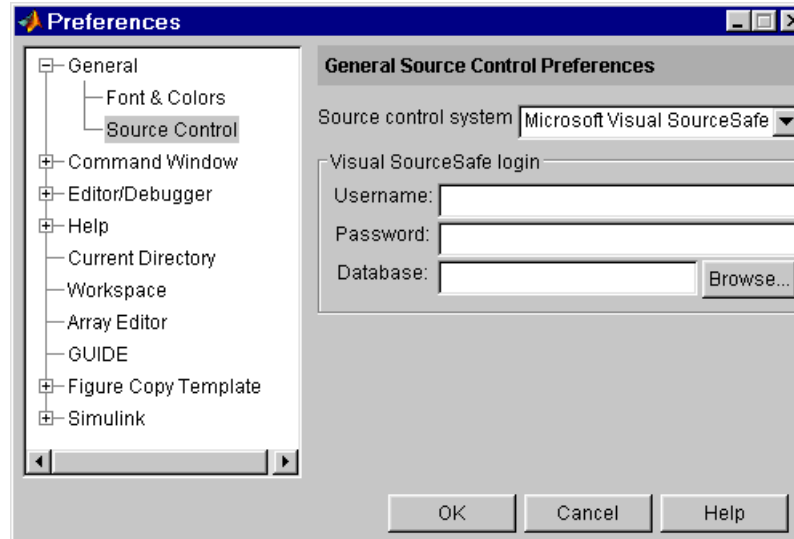

- 3 Select the system you want to use from the **Source control system** list.

4 For Visual SourceSafe only, supply your **Username**, **Password**, and the **Database**.

- **Password** is not required if SourceSafe does not require it.
- **Database** is the full path for the srcsafe.ini file associated with the SourceSafe database you want to use. For example,
D:\Applications\Microsoft SourceSafe\srcsafe.ini.

5 Click **OK**.

Function Alternative for Viewing the SCS

To view the currently selected system, type `cmopts` in the Command Window. MATLAB displays the current source control system.

Setting Up the Source Control System

For ClearCase on UNIX and for SourceSafe, set up your source control system as described here.

For SourceSafe Only – Mirroring MATLAB Hierarchy

If you use Visual SourceSafe, you must set up a project hierarchy in SourceSafe that mirrors the hierarchy of your MATLAB, Simulink, and Stateflow files. For example, if you want to use the MATLAB Editor to interface to SourceSafe for the files in `D:\matlabr12\myfiles`, configure a SourceSafe project as `$.matlabr12\myfiles`.

In addition to setting up the hierarchy, you must supply your user name, password, and database in MATLAB general preferences. See “Viewing or Selecting the Source Control System” on page 9-4 for instructions.

For ClearCase on UNIX Only – Set a View and Check Out a Directory

If you use ClearCase on a UNIX platform, do the following using ClearCase:

- 1 Set a view.
- 2 Check out the directory in which you want to save files, check files into, or check files out of.

You can now use the MATLAB, Simulink, or Stateflow interfaces to ClearCase to check files into and out of the directory you checked out in step 2.

Checking Files into the Source Control System

After creating or editing a file in the MATLAB Editor, Simulink, or Stateflow, save it, and then check in the file by following these steps:

- 1 From the MATLAB Editor, select **File -> Source Control -> Check In**. You can also select this from the Simulink or Stateflow model or library windows.

The **Check in** dialog box opens.

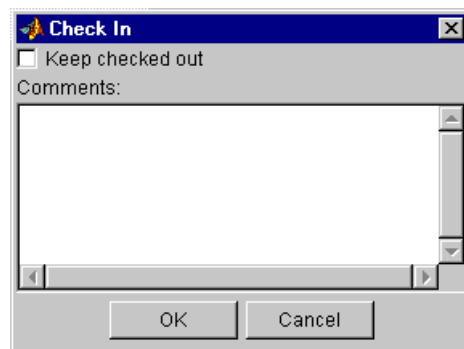

- 2 If you want to check in the file but keep it checked out so you can continue making changes, select **Keep checked out**.
- 3 If you have comments, type them in the **Comments** area.
Your comments will be submitted whether or not you select **Keep checked out**, y.
- 4 Click **OK**.

The file is checked into the source control system. If you did not save the file before checking it in, it is automatically saved when it is checked in.

If you did not keep the file checked out and you keep the file open, note that it is a read-only version.

Function Alternative for Checking In Files

Use `checkin` to check files into the source control system. The files can be open or closed when you use `checkin`. The `checkin` function has this form.

```
checkin({'file1',... 'filen'}, 'comments', 'string', 'option', ...  
       'value')
```

For `file`, use the complete path. You must supply the `comments` argument and a `comments` string with `checkin`.

Use the `option` argument to:

- Check in a file and keep it checked out – set the `lock` option to `on`.
- Check in a file even though it has not changed since the previous check in – set the `force` option to `on`.

The `comments` argument, and the `lock` and `force` options apply to all files checked in.

After checking in the file, if you did not keep it checked out and have it open, note that it is a read-only version.

Example – Check in a File with Comments

To check in the file `clock.m` with a comment `Adjustment for Y2K`, type

```
checkin('\matlabr12\myfiles\clock.m', 'comments', 'Adjustment ...  
for Y2K')
```

For other examples, see the reference page for `checkin`.

Checking Files Out of the SCS

To check files out of the source control system using MATLAB, follow these steps:

- 1 Open the M-file, Simulink file, or Stateflow file you want to check out.

The file opens and the title bar indicates it is read-only.

- 2 From the MATLAB Editor, select **File -> Source Control -> Check Out**. You can also select this from the Simulink or Stateflow model or library windows.

The **Check-Out** dialog box opens.

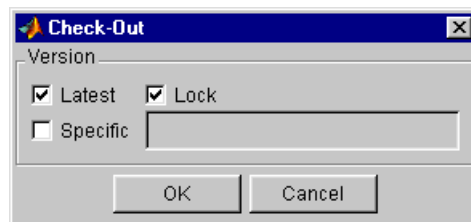

- 3 To check out the version that was most recently checked in, select **Latest**. To check out a specific version of the file, select **Specific** and type the version number in the field

When you check out the latest version, you can use the Lock option. To prevent others from checking out the file while you have it checked out, select **Lock**. To check out a read-only version of the file, uncheck **Lock**.

- 4 Click **OK**.

The file is checked out from the source control system and is available to you for editing.

Function Alternative for Checking Out Files

Use `checkout` to check a file out of the source control system. You can check out multiple files at once and specify check-out options. The `checkout` function has this form.

```
checkout({'file1',... 'filen'}, 'option', 'value')
```

For `file`, use the complete path.

Use the `option` argument to:

- Check out a read-only version of the file – set the `lock` option to `off`.
- Check out the file even if you already have it checked out – set the `force` option to `on`.
- Check out a specific revision of the file – use the `revision` option, and assign the revision number to the `value` argument.

The options apply to all files checked out. The file can be open or closed when you use `checkout`.

Example – Check out a Specific Revision of a File

To check out the 1.1 revision of the file `clock.m`, type

```
checkout('\matlab\mymfiles\clock.m', 'revision', '1.1')
```

For other examples, see the reference page for `checkout`.

Undoing the Check-Out

You can undo the check-out for a file. The files remain checked in, without any of the changes you made since you checked them out. If you want to keep a local copy of your changes, use the **Save As** item from the **File** menu.

From the MATLAB Editor, select **File -> Source Control -> Undo Check Out**. You can also select this from the Simulink or Stateflow model or library windows.

Function Alternative for Undoing a Check-Out

The `undocheckout` function has this form.

```
undocheckout({'file1',... 'filen'})
```

Use the complete path for `file`.

Example – Undo the Check-Out for Two Files. To undo the check-out for the files `clock.m` and `calendar.m`, type

```
undocheckout({'\matlab\myfiles\clock.m',  
'\matlab\myfiles\calendar.m'})
```

Using Notebook

Notebook Basics	10-3
Creating an M-Book	10-3
Entering MATLAB Commands in an M-Book	10-6
Protecting the Integrity of Your Workspace	10-6
Ensuring Data Consistency	10-7
Defining MATLAB Commands as Input Cells	10-8
Defining Cell Groups	10-8
Defining Autoinit Input Cells	10-10
Defining Calc Zones	10-10
Converting an Input Cell to Text	10-11
Evaluating MATLAB Commands	10-12
Evaluating Cell Groups	10-13
Evaluating a Range of Input Cells	10-14
Evaluating a Calc Zone	10-14
Evaluating an Entire M-Book	10-15
Using a Loop to Evaluate Input Cells Repeatedly	10-15
Converting Output Cells to Text	10-16
Deleting Output Cells	10-17
Printing and Formatting an M-Book	10-18
Printing an M-Book	10-18
Modifying Styles in the M-Book Template	10-18
Choosing Loose or Compact Format	10-19
Controlling Numeric Output Format	10-20
Controlling Graphic Output	10-20
Configuring Notebook	10-24
Notebook Command Reference	10-26

Notebook allows you to access MATLAB's numeric computation and visualization software from within a word processing environment (Microsoft Word). Using Notebook, you can create a document, called an *M-book*, that contains text, MATLAB commands, and the output from MATLAB commands.

You can think of an M-book as a record of an interactive MATLAB session annotated with text or as a document embedded with live MATLAB commands and output. Notebook is useful for creating electronic or printed records of MATLAB sessions, class notes, textbooks or technical reports.

This section provides information about:

- “Notebook Basics” on page 10-3
- “Defining MATLAB Commands as Input Cells” on page 10-8
- “Evaluating MATLAB Commands” on page 10-12
- “Printing and Formatting an M-Book” on page 10-18
- “Configuring Notebook” on page 10-24
- “Notebook Command Reference” on page 10-26.

Notebook Basics

This section introduces basic Notebook capabilities, including:

- “Creating an M-Book” on page 10-3
- “Entering MATLAB Commands in an M-Book” on page 10-6
- “Protecting the Integrity of Your Workspace” on page 10-6
- “Ensuring Data Consistency” on page 10-7

Creating an M-Book

This section describes how to:

- Create an M-book from MATLAB
- Create an M-book while running Notebook
- Open an existing M-book
- Convert a Word document into an M-book

Creating an M-Book from MATLAB

To create a new M-book from within MATLAB, type

```
notebook
```

at the prompt. If you are running Notebook for the first time, you may need to configure it. See “Configuring Notebook” on page 10-24 for more information.

Notebook starts Microsoft Word on your system and creates a new M-book, called Document1. Notebook adds the **Notebook** menu to the Word menu bar. You use this menu, illustrated below, to access Notebook commands.

Note Notebook defines Microsoft Word macros that enable MATLAB to interpret the different types of cells that hold MATLAB commands and their output.

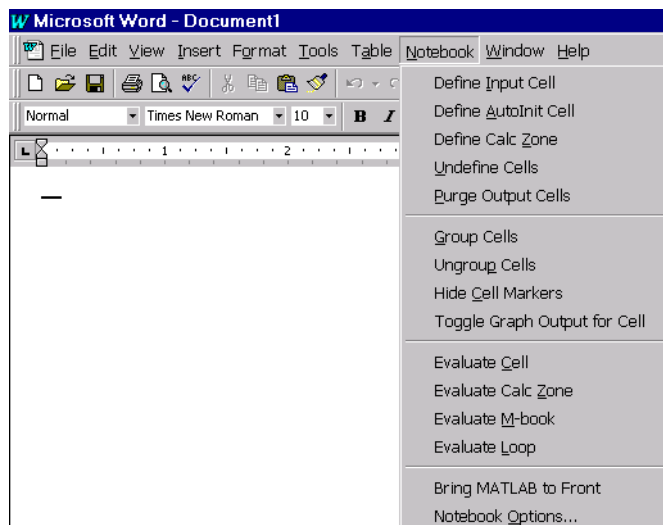

Creating an M-Book While Running Notebook

With Notebook running, you can also create a new M-book by selecting **New M-book** from the Word **File** menu.

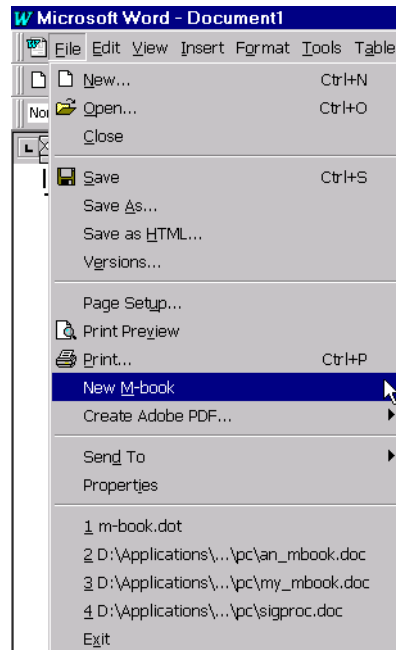

Opening an Existing M-Book

You can also use the notebook command to open an existing M-book

```
notebook filename
```

where `filename` is the M-book you want to open, or you can simply double-click on an M-book file.

When you double-click on an M-book, Microsoft Word opens the M-book and starts MATLAB, if it is not already running. Notebook adds the **Notebook** menu to the Word menu bar.

Converting a Word Document to an M-Book

To convert a Word document to an M-book, follow these steps:

- 1 Create a new M-book.
- 2 From the **Insert** menu, select the **File** command.

3 Select the file you want to convert.

4 Click on the **OK** button.

Entering MATLAB Commands in an M-Book

Note A good way to learn how to use Notebook is to open the sample M-book, `Readme.doc`, and try out the various techniques described in this section. You can find this file in the `$MATLAB\notebook\pc` directory, where `$MATLAB` represents your installation directory.

You enter MATLAB commands in an M-book the same way you enter text in any other Word document. For example, you can enter the following text in a Word document. The example uses text in Courier Font but you can use any font.

```
Here is a sample M-book.
```

```
a = magic(3)
```

To execute the MATLAB `magic` command in this document, you must:

- Define the command as an input cell
- Evaluate the input cell.

MATLAB displays the output of the command in the Word document in an output cell.

Protecting the Integrity of Your Workspace

When you work on more than one M-book in a single word processing session, note that:

- Each M-book uses the same “copy” of MATLAB.
- All M-books share the same workspace.

If you use the same variable names in more than one M-book, data used in one M-book can be affected by another M-book. You can protect the integrity of your

workspace by specifying the `clear` command as the first autoinit cell in the M-book.

Ensuring Data Consistency

An M-book can be thought of as a sequential record of a MATLAB session. When executed in order, from the first MATLAB command to the last, the M-book accurately reflects the relationships among these commands.

If, however, you change an input cell or output cell as you refine your M-book, Notebook does not automatically recalculate input cells that depend on either the contents or the results of the changed cells. As a result, the M-book may contain inconsistent data.

When working on an M-book, you might find it useful to select the **Evaluate M-book** command periodically to ensure that your M-book data is consistent. You could also use calc zones to isolate related commands in a section of the M-book. You can then use the **Evaluate Calc Zone** command to execute only those input cells contained in the calc zone.

Defining MATLAB Commands as Input Cells

To define a MATLAB command in a Word document as an input cell:

- 1 Type the command into the M-book as text. For example,

This is a sample M-book.

```
a = magic(3)
```

- 2 Position the cursor anywhere in the command and choose the **Define Input Cell** command from the Notebook menu or press **Alt+D**. If the command is embedded in a line of text, use the mouse to select it. Notebook defines the MATLAB command as an input cell.

This is a sample M-book.

```
[a = magic(3)]
```

Note how Notebook changes the character font of the text in the input cell to a bold, dark green color and encloses it within *cell markers*. Cell markers are bold, gray brackets. They differ from the brackets used to enclose matrices by their size and weight. For information about changing these default formats, see “Modifying Styles in the M-Book Template” on page 10-18.

For information about defining other types of input cells, see:

- “Defining Cell Groups” on page 10-8
- “Defining Autoinit Input Cells” on page 10-10
- “Defining Calc Zones” on page 10-10
- “Converting an Input Cell to Text” on page 10-11

For information about evaluating the input cells you define, see “Evaluating MATLAB Commands” on page 10-12.

Defining Cell Groups

You can collect several input cells into a single input cell. This is called a *cell group*. Because all the output from a cell group appears in a single output cell that Notebook places immediately after the group, cell groups are useful when several MATLAB commands are needed to fully define a graphic.

For example, if you define all the MATLAB commands that produce a graphic as a cell group and then evaluate the cell, Notebook generates a single graphic that includes all the graphic components defined in the commands. If instead you define all the MATLAB commands that generate the graphic as separate input cells, evaluating the cells generates multiple graphic output cells.

See “Evaluating Cell Groups” on page 10-13 for information about evaluating a cell group. For information about undefining a cell group, see “Ungroup Cells Command” on page 10-32.

Creating a Cell Group

To create a cell group:

- 1 Use the mouse to select the input cells that are to make up the group.
- 2 Select the **Group Cells** command from the Notebook menu or press **Alt+G**.

Notebook converts the selected cells into a cell group and replaces cell markers with a single pair that surrounds the group.

This is a sample cell group.

```
[date  
a = magic(3) ]
```

Note the following:

- A cell group cannot contain text or output cells. If the selection includes output cells, Notebook deletes them.
- If the selection includes text, Notebook places the text after the cell group. However, if the text precedes the first input cell in the selection, Notebook leaves it where it is.
- If you select part or all of an output cell but not its input cell, Notebook includes the input cell in the cell group.

When you create a cell group, Notebook defines it as an input cell unless its first line is an autoinit cell, in which case Notebook defines the group as an autoinit cell.

Defining Autoinit Input Cells

You can use *autoinit cells* to specify MATLAB commands to be automatically evaluated each time an M-book is opened. This is a quick and easy way to initialize the workspace. *Autoinit cells* are simply input cells with the following additional characteristics:

- Notebook evaluates the autoinit cells when it opens the M-book.
- Notebook displays the commands in autoinit cells using dark blue characters.

Autoinit cells are otherwise identical to input cells.

Creating an Autoinit Cell

You can create an autoinit cell in two ways:

- Enter the MATLAB command as text, then convert the command to an autoinit cell by selecting the **Define AutoInit Cell** command from the Notebook menu.
- If you already entered the MATLAB command as an input cell, you can convert the input cell to an autoinit cell. Either select the input cell or position the cursor in the cell, then select the **Define AutoInit Cell** command from the Notebook menu.

See “Evaluating MATLAB Commands” on page 10-12 for information about evaluating autoinit cells.

Defining Calc Zones

You can partition an M-book into self-contained sections, called *calc zones*. A calc zone is a contiguous block of text, input cells, and output cells. Notebook inserts Microsoft Word section breaks before and after the section to define the calc zone. The section break indicators include bold, gray brackets to distinguish them from standard Word section breaks.

You can use calc zones to prepare problem sets, making each problem a separate calc zone that can be created and tested on its own. An M-book can contain any number of calc zones.

Note Using calc zones does not affect the scope of the variables in an M-book. Variables used in one calc zone are accessible to all calc zones.

Creating a Calc Zone

After you create the text and cells you want to include in the calc zone, you define the calc zone by following these steps:

- 1 Select the input cells and text to be included in the calc zone.
- 2 Choose the **Define Calc Zone** command from the Notebook menu.

Note You must select an input cell and its output cell in their entirety to include them in the calc zone.

See “Evaluating a Calc Zone” on page 10-14 for information about evaluating a calc zone.

Converting an Input Cell to Text

To convert an input cell (or an autoinit cell or a cell group) to text:

- 1 Select the input cell with the mouse or position the cursor in the input cell.
- 2 Select the **Undefine Cells** command from the Notebook menu or press **Alt+U**.

When Notebook converts the cell to text, it reformats the cell contents according to the Microsoft Word Normal style. For more information about M-book styles, see “Modifying Styles in the M-Book Template” on page 10-18. When you convert an input cell to text, Notebook also converts the corresponding output cell to text.

Evaluating MATLAB Commands

After you define a MATLAB command as an input cell, or as an autoint cell, you can evaluate it in your M-book. Use the following steps to define and evaluate a MATLAB command:

- 1 Type the command into the M-book as text. For example,

```
This is a sample M-book
```

```
a = magic(3)
```

- 2 Position the cursor anywhere in the command and choose the **Define Input Cell** command from the Notebook menu or press **Alt+D**. If the command is embedded in a line of text, use the mouse to select it. Notebook defines the MATLAB command as an input cell. For example,

```
This is a sample M-book
```

```
[a = magic(3)]
```

- 3 Choose the **Evaluate Cell** command from the Notebook menu or press **Ctrl+Enter**. You can specify the input cell to be evaluated by selecting it with the mouse, or placing the cursor in it.

Notebook evaluates the input cell and displays the results in a output cell immediately following the input cell. If there is already an output cell, Notebook replaces its contents, wherever it is in the M-book. For example,

```
This is a sample M-book.
```

```
[a = magic(3) ]
```

```
[a =  
8      1      6  
3      5      7  
4      9      2 ]
```

The text in the output cell is blue and is enclosed within cell markers. Cell markers are bold, gray brackets. They differ from the brackets used to enclose matrices by their size and weight. Error messages appear in red. For

information about changing these default formats, see “Modifying Styles in the M-Book Template” on page 10-18.

For more information about evaluating MATLAB commands in an M-book, see:

- “Evaluating Cell Groups” on page 10-13
- “Evaluating a Range of Input Cells” on page 10-14
- “Evaluating a Calc Zone” on page 10-14
- “Evaluating an Entire M-Book” on page 10-15
- “Using a Loop to Evaluate Input Cells Repeatedly” on page 10-15.
- “Converting Output Cells to Text” on page 10-16
- “Deleting Output Cells” on page 10-17

Evaluating Cell Groups

You evaluate a cell group the same way you evaluate an input cell (because a cell group is an input cell):

- 1 Position the cursor anywhere in the cell or in its output cell.
- 2 Choose the **Evaluate Cell** command from the Notebook menu or press **Ctrl+Enter**.

For information about creating a cell group, see “Defining Cell Groups” on page 10-8.

When MATLAB evaluates a cell group, the output for all commands in the group appears in a single output cell. By default, Notebook places the output cell immediately after the cell group the first time the cell group is evaluated. If you evaluate a cell group with an existing output cell, Notebook places the results in the output cell wherever it is located in the M-book.

Note Text or numeric output always comes first, regardless of the order of the commands in the group.

The illustration shows a cell group and the figure created when you evaluate the cell group.

This is a sample M-book with a cell group.

```
t = 0:pi/100:2*pi;  
y = sin(t);  
plot(t,y) ]
```

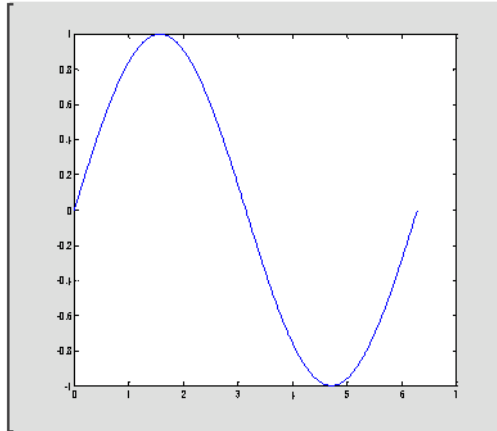

Evaluating a Range of Input Cells

To evaluate more than one MATLAB command contained in different but contiguous input cells:

- 1 Select the range of cells that includes the input cells you want to evaluate. You can include text that surrounds input cells in your selection.
- 2 Choose the **Evaluate Cell** command from the Notebook menu or press **Ctrl+Enter**.

Notebook evaluates each input cell in the selection, inserting new output cells or replacing existing ones.

Evaluating a Calc Zone

To evaluate a calc zone:

- 1 Position the cursor anywhere in the calc zone.

- 2 Select the **Evaluate Calc Zone** command from the Notebook menu or press **Alt+Enter**.

For information about creating a calc zone, see “Defining Calc Zones” on page 10-10.

By default, Notebook places the output cell immediately after the calc zone the first time the calc zone is evaluated. If you evaluate a calc zone with an existing output cell, Notebook places the results in the output cell wherever it is located in the M-book.

Evaluating an Entire M-Book

To evaluate the entire M-book, either select the **Evaluate M-book** command or press **Alt+R**.

Notebook begins at the top of the M-book regardless of the cursor position and evaluates each input cell in the M-book. As it evaluates the M-book, Notebook inserts new output cells or replaces existing output cells.

Controlling Execution of Multiple Commands

When you evaluate an entire M-book, and an error occurs, evaluation continues. If you want to stop evaluation if an error occurs, follow this procedure:

- 1 Choose **Notebook Options** from the Notebook menu.
- 2 Click the **Stop evaluating on error** check box.

Using a Loop to Evaluate Input Cells Repeatedly

To evaluate a sequence of MATLAB commands repeatedly:

- 1 Use the mouse to select the input cells, including any text or output cells located between them.
- 2 Choose the **Evaluate Loop** command or press **Alt+L**. Notebook displays the **Evaluate Loop** dialog box.

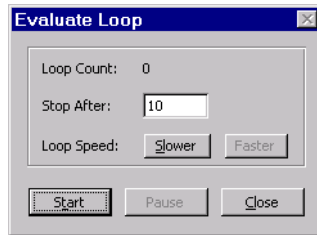

- 3 Enter the number of times you want MATLAB to evaluate the selected commands in the **Stop After** field, then click on the **Start** button. The label on the button changes to **Stop**. Notebook begins evaluating the commands and indicates the number of completed iterations in the **Loop Count** field.

You can increase or decrease the delay at the end of each iteration by clicking on the **Slower** or **Faster** button. Slower increases the delay. Faster decreases the delay.

To suspend evaluation of the commands, click on the **Pause** button. The label on the button changes to **Resume**. Click on the **Resume** button to continue evaluation.

To stop processing the commands, click on the **Stop** button. To close the **Evaluate Loop** dialog box, click on the **Close** button.

Converting Output Cells to Text

You can convert an output cell to text using the **Undefine Cells** command. If the output is numeric or textual, Notebook removes the cell markers and converts the cell contents to text according to the Microsoft Word Normal style. If the output is graphical, Notebook removes the cell markers and dissociates the graphic from its input cell, but does not alter its contents.

Note Undefining an output cell does not affect the associated input cell.

To undefine an output cell:

- 1 Select the output cell you want to undefine.

- 2 Choose the **Undefine Cells** command from the Notebook menu or press **Alt+U**.

Deleting Output Cells

To delete output cells:

- 1 Select an output cell, using the mouse, or place the cursor in the output cell.
- 2 Choose the **Purge Output Cells** command from the Notebook menu or press **Alt+P**.

If you select a range of input cells, each with output cells, Notebook deletes all the associated output cells.

Printing and Formatting an M-Book

This section describes:

- “Printing an M-Book” on page 10-18
- “Modifying Styles in the M-Book Template” on page 10-18
- “Choosing Loose or Compact Format” on page 10-19
- “Controlling Numeric Output Format” on page 10-20
- “Controlling Graphic Output” on page 10-20

Printing an M-Book

You can print all or part of an M-book by selecting the **Print** command from the **File** menu. Word follows these rules when printing M-book cells and graphics:

- Cell markers are not printed.
- Input cells, autoinit cells, and output cells (including error messages) are printed according to their defined styles. If you prefer to print these cells using black type instead of colors or shades of gray, you can modify the styles.

Modifying Styles in the M-Book Template

You can control the appearance of the text in your M-book by modifying the predefined styles stored in the M-book template. These styles control the appearance of text and cells. By default, M-books use the Word Normal style for all other text.

For example, if you print an M-book on a color printer, input cells appear dark green, output and autoinit cells appear dark blue, and error messages appear red. If you print the M-book on a grayscale printer, these cells appear as shades of gray. To print these cells using black type, you need to modify the color of the Input, Output, AutoInit, and Error styles in the M-book template.

The table below describes the default styles used by Notebook. If you modify styles, you can use the information in the tables below to help you return the styles to their original settings. For general information about using styles in Word documents, see the Word documentation.

Style	Font	Size	Weight	Color
Normal	Times New Roman	10 points		Black
AutoInit	Courier New	10 points	Bold	Dark Blue
Error	Courier New	10 points	Bold	Red
Input	Courier New	10 points	Bold	Dark Green
Output	Courier New	10 points		Blue

When you change a style, Word applies the change to all characters in the M-book that use that style and gives you the option to change the template. Be cautious about making changes to the template. If you choose to apply the changes to the template, you will affect all new M-books you create using the template. See the Word documentation for more information.

Choosing Loose or Compact Format

You can specify whether a blank line appears between the input and output cells by selecting Loose or Compact format.

- 1 Click on the Notebook menu and select **Notebook Options**.
- 2 In the **Notebook Options** dialog box, select either the Loose or Compact check box. Loose format adds an empty line. Compact format does not.

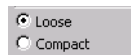

- 3 Click **OK**.

Note Changes you make using the **Notebook Options** dialog box take effect for output generated *after* you click on the **OK** button. To affect existing input or output cells, you must re-evaluate the cells.

Controlling Numeric Output Format

To change how Notebook displays numeric output:

- 1 Click on the Notebook menu and select **Notebook Options**.
- 2 In the **Notebook Options** dialog box, click on the **Numeric Format** menu to view a list of available formats. These settings correspond to the choices available with the MATLAB `format` command. The figure below shows the available numeric formats.

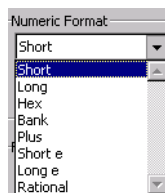

- 3 Click **OK**.

Note Changes you make using the **Notebook Options** dialog box take effect for output generated *after* you click on the **OK** button. To affect existing input or output cells, you must re-evaluate the cells.

Controlling Graphic Output

This section describes how to control several aspects of the graphic output produced by MATLAB commands in an M-book, including:

- “Embedding Graphic Output in the M-Book” on page 10-21
- “Suppressing Graphic Output for Individual Input Cells” on page 10-21
- “Sizing Graphic Output” on page 10-22
- “Cropping Graphic Output” on page 10-22
- “Adding White Space Around Graphic Output” on page 10-22
- “Specifying Color Mode” on page 10-23

Embedding Graphic Output in the M-Book

By default, graphic output is embedded in an M-book. To display graphic output in a separate figure window:

- 1 Click on the Notebook menu and choose **Notebook Options**.
- 2 In the **Notebook Options** dialog box, deselect the **Embed Figures in M-book** check box.

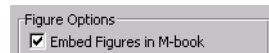

- 3 Click **OK**.

Note Embedded figures do not include Handle Graphics® objects generated by the `uicontrol` and `uimenu` functions.

Notebook determines whether to embed a figure in the M-book by examining the value of the figure object's `Visible` property. If the value of the property is `off`, Notebook embeds the figure. If the value of this property is `on`, all graphic output is directed to the current figure window.

Suppressing Graphic Output for Individual Input Cells

If an input or autoint cell generates figure output that you want to suppress:

- 1 Place the cursor in the input cell.
- 2 Click on the Notebook menu and choose the **Toggle Graph Output for Cell** command.

Notebook suppresses graphic output from the cell, inserting the string (no graph) after the input cell.

To allow graphic output for a cell, repeat the same procedure. Notebook allows graphic output from the cell and removes the (no graph) marker.

Note The **Toggle Graph Output for Cell** command overrides the **Embed Figures in M-book** option, if that option is set.

Sizing Graphic Output

To set the default size of embedded graphics in an M-book:

- 1 Click on the Notebook menu and choose **Notebook Options**.
- 2 In the **Notebook Options** dialog box, use the **Height** and **Width** fields to set the size of graphics generated by the M-book.
- 3 Click **OK**.

Note Changes you make using the **Notebook Options** dialog box take effect for graphic output generated *after* you click on the **OK** button. To affect existing input or output cells, you must re-evaluate the cells.

You change the size of an existing embedded figure by selecting the figure, clicking the left mouse button anywhere in the figure, and dragging the resize handles of the figure. If you resize an embedded figure using its handles and then regenerate the figure, its size reverts to its original size.

Cropping Graphic Output

To crop an embedded figure to cut off areas you do not want to show:

- 1 Select the graphic, by clicking the left mouse button anywhere in the figure.
- 2 Hold down the **Shift** key.
- 3 Drag a sizing handle toward the center of the graphic.

Adding White Space Around Graphic Output

You can add white space around an embedded figure by moving the boundaries of a graphic outward. Select the graphic, then hold down the **Shift** key and drag a sizing handle away from the graphic.

Specifying Color Mode

If you print graphic output that includes surfaces or patches, the output uses 16-color mode by default. To use 256-color mode:

- 1 Click on the Notebook menu and choose **Notebook Options**.
- 2 Deselect the **Use 16-Color Figures** check box in the **Notebook Options** dialog box.

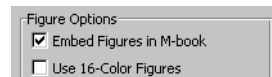

- 3 Click **OK**.

Note Changes you make using the **Notebook Options** dialog box take effect for graphic output generated *after* you click on the **OK** button. To affect existing input or output cells, you must re-evaluate the cells.

Configuring Notebook

After you install Notebook, you must configure it. (Notebook is installed as part of the MATLAB installation process. See the *MATLAB Installation Guide for PC* for more information.)

To configure Notebook, type

```
notebook -setup
```

in the MATLAB command window. Notebook prompts you to specify which version of Microsoft Word you are using.

Choose your version of Microsoft Word:

- [1] Microsoft Word for Windows 95 (Version 7.0)
- [2] Microsoft Word 97
- [3] Microsoft Word 2000
- [4] Exit, making no changes

Microsoft Word Version: 2

Next Notebook prompts you to specify the location of the Microsoft Word executable (`winword.exe`) on your system.

You will be presented with a dialog box. Please use it to select your copy of the Microsoft Word 97 executable (`winword.exe`). Press any key to continue...

Use this dialog box to specify the location of your Microsoft Word program.



When you click **Open**, Notebook prompts you to specify the name of a Microsoft Word template file.

You will be presented with a dialog box. Please use it to select a Microsoft Word template (.dot) file in one of your Microsoft Word template directories. We suggest that you specify your normal.dot file.

Press any key to continue...

Use this dialog box to specify the name of your Microsoft Word template file.

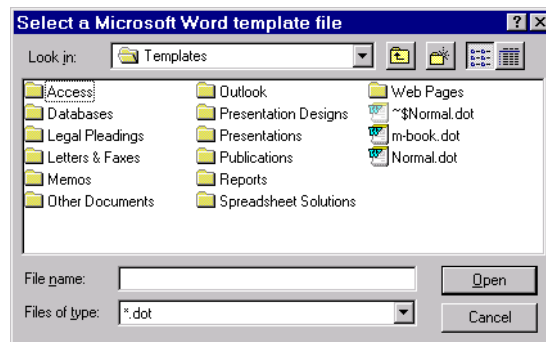

When configuration is completed, Notebook outputs this message.

Notebook setup is complete.

Notebook Command Reference

This section provides reference information about each of the Notebook commands, listed alphabetically. To use these commands, select them from the Notebook menu.

- “Bring MATLAB to Front Command” on page 10-26
- “Define Autoinit Cell Command” on page 10-26
- “Define Calc Zone Command” on page 10-27
- “Define Input Cell Command” on page 10-27
- “Evaluate Calc Zone Command” on page 10-28
- “Evaluate Cell Command” on page 10-28
- “Evaluate Loop Command” on page 10-29
- “Evaluate M-Book Command” on page 10-30
- “Group Cells Command” on page 10-30
- “Hide Cell Markers Command” on page 10-31
- “Notebook Options Command” on page 10-31
- “Purge Output Cells Command” on page 10-31
- “Toggle Graph Output for Cell Command” on page 10-31
- “Undefine Cells Command” on page 10-32
- “Ungroup Cells Command” on page 10-32

Bring MATLAB to Front Command

The **Bring MATLAB to Front** command brings the MATLAB command window to the foreground.

Define Autoinit Cell Command

The **Define AutoInit Cell** command creates an autoinit cell by converting the current paragraph, selected text, or input cell. An autoinit cell is an input cell that is automatically evaluated whenever you open an M-book.

Action

If you select this command while the cursor is in a paragraph of text, Notebook converts the entire paragraph to an autoinit cell. If you select this command

while text is selected, Notebook converts the text to an autoinit cell. If you select this command while the cursor is in an input cell, Notebook converts the input cell to an autoinit cell.

Format

Notebook formats the autoinit cell using the AutoInit style, defined as bold, dark blue, 10-point Courier New.

See Also

For more information about autoinit cells, see “Defining Autoinit Input Cells” on page 10-10.

Define Calc Zone Command

The **Define Calc Zone** command defines the selected text, input cells, and output cells as a calc zone. A calc zone is a contiguous block of related text, input cells, and output cells that describes a specific operation or problem.

Action

Notebook defines a calc zone as a Word document section, placing section breaks before and after the calc zone. However, Word does not display section breaks at the beginning or end of a document.

See Also

For information about evaluating calc zones, see “Evaluating a Calc Zone” on page 10-14. For more information about document sections, see the Microsoft Word documentation.

Define Input Cell Command

The **Define Input Cell** command creates an input cell by converting the current paragraph, selected text, or autoinit cell. An input cell contains a MATLAB command.

Action

If you select this command while the cursor is in a paragraph of text, Notebook converts the entire paragraph to an input cell. If you select this command while text is selected, Notebook converts the text to an input cell.

If you select this command while the cursor is in an autoinit cell, Notebook converts the autoinit cell to an input cell.

Format

Notebook encloses the text in cell markers and formats the cell using the Input style, defined as bold, dark green, 10-point Courier New.

See Also

For more information about creating input cells, see “Defining MATLAB Commands as Input Cells” on page 10-8. For information about evaluating input cells, see “Evaluating MATLAB Commands” on page 10-12.

Evaluate Calc Zone Command

The **Evaluate Calc Zone** command sends the input cells in the current calc zone to MATLAB to be evaluated. A calc zone is a contiguous block of related text, input cells, and output cells that describes a specific operation or problem.

The current calc zone is the Word section that contains the cursor.

Action

As Notebook evaluates each input cell, it generates an output cell. When you evaluate an input cell for which there is no output cell, Notebook places the output cell immediately after the input cell that generated it. If you evaluate an input cell for which there is an output cell, Notebook replaces the results in the output cell wherever it is in the M-book.

See Also

For more information, see “Evaluating a Calc Zone” on page 10-14.

Evaluate Cell Command

The **Evaluate Cell** command sends the current input cell or cell group to MATLAB to be evaluated. An input cell contains a MATLAB command. A cell group is a single, multiline input cell that contains more than one MATLAB command. Notebook displays the output or an error message in an output cell.

Action

If you evaluate an input cell for which there is no output cell, Notebook places the output cell immediately after the input cell that generated it. If you evaluate an input cell for which there is an output cell, Notebook replaces the results in the output cell wherever it is in the M-book. If you evaluate a cell group, all output for the cell appears in a single output cell.

An input cell or cell group is the current input cell or cell group if:

- The cursor is in the input cell or cell group.
- The cursor is at the end of the line that contains the closing cell marker for the input cell or cell group.
- The cursor is in the output cell for the input cell or cell group.
- The input cell or cell group is selected.

Note Evaluating a cell that involves a lengthy operation may cause a time-out. If this happens, Word displays a time-out message and asks whether you want to continue waiting for a response or terminate the request. If you choose to continue, Word resets the time-out value and continues waiting for a response. Word sets the time-out value; you cannot change it.

See Also

For more information, see “Evaluating MATLAB Commands” on page 10-12. For information about evaluating the entire M-book, see “Evaluating an Entire M-Book” on page 10-15.

Evaluate Loop Command

The **Evaluate Loop** command evaluates the selected input cells repeatedly.

For more information, see “Using a Loop to Evaluate Input Cells Repeatedly” on page 10-15.

Evaluate M-Book Command

The **Evaluate M-book** command evaluates the entire M-book, sending all input cells to MATLAB to be evaluated. Notebook begins at the top of the M-book regardless of the cursor position.

Action

As Notebook evaluates each input cell, it generates an output cell. When you evaluate an input cell for which there is no output cell, Notebook places the output cell immediately after the input cell that generated it. If you evaluate an input cell for which there is an output cell, Notebook replaces the results in the output cell wherever it is in the M-book.

See Also

For more information, see “Evaluating an Entire M-Book” on page 10-15.

Group Cells Command

The **Group Cells** command converts the input cells in the selection into a single multiline input cell called a cell group. You evaluate a cell group using the **Evaluate Cell** command. When you evaluate a cell group, all of its output follows the group and appears in a single output cell.

Action

If you include text in the selection, Notebook moves it after the cell group. However, if text precedes the first input cell in the group, the text will remain before the group.

If you include output cells in the selection, Notebook deletes them. If you select all or part of an output cell before selecting this command, Notebook includes its input cell in the cell group.

If the first line in the cell group is an autoinit cell, the entire group acts as a sequence of autoinit cells. Otherwise, the group acts as a sequence of input cells. You can convert an entire cell group to an autoinit cell with the **Define AutoInit Cell** command.

See Also

For more information, see “Defining Cell Groups” on page 10-8. For information about converting a cell group to individual input cells, see the description of the “Ungroup Cells Command” on page 10-32.

Hide Cell Markers Command

The **Hide Cell Markers** command hides cell markers in the M-book.

When you select this command, it changes to **Show Cell Markers**.

Note Notebook does not print cell markers whether you choose to hide them or show on the screen.

Notebook Options Command

The **Notebook Options** command allows you to examine and modify display options for numeric and graphic output.

See Also

See “Printing and Formatting an M-Book” on page 10-18 for more information.

Purge Output Cells Command

The **Purge Output Cells** command deletes all output cells from the current selection.

See Also

For more information, see “Deleting Output Cells” on page 10-17.

Toggle Graph Output for Cell Command

The **Toggle Graph Output for Cell** command suppresses or allows graphic output from an input cell.

If an input or autoinit cell generates figure output that you want to suppress, place the cursor in the input cell and choose this command. The string (no

graph) will be placed after the input cell to indicate that graph output for that cell will be suppressed.

To allow graphic output for that cell, place the cursor inside the input cell and choose **Toggle Graph Output for Cell** again. The (no graph) marker will be removed. This command overrides the Embed Graphic Output in the M-Book option, if that option is set in the **Notebook Options** dialog.

See Also

See “Embedding Graphic Output in the M-Book” on page 10-21 and “Suppressing Graphic Output for Individual Input Cells” on page 10-21 for more information.

Undefine Cells Command

The **Undefine Cells** command converts the selected cells to text. If no cells are selected but the cursor is in a cell, Notebook undefines that cell. Notebook removes the cell markers and reformats the cell according to the Normal style.

If you undefine an input cell, Notebook automatically undefines its output cell. However, if you undefine an output cell, Notebook does not undefine its input cell. If you undefine an output cell containing an embedded graphic, the graphic remains in the M-book but is no longer associated with an input cell.

See Also

For information about the Normal style, see “Modifying Styles in the M-Book Template” on page 10-18. For information about deleting output cells, see the description of the “Purge Output Cells Command” on page 10-31.

Ungroup Cells Command

The **Ungroup Cells** command converts the current cell group into a sequence of individual input cells or autoinit cells. If the cell group is an input cell, Notebook converts the cell group to input cells. If the cell group is an autoinit cell, Notebook converts the cell group to autoinit cells. Notebook deletes the output cell for the cell group.

A cell group is the current cell group if:

- The cursor is in the cell group.

- The cursor is at the end of a line that contains the closing cell marker for the cell group.
- The cursor is in the output cell for the cell group.
- The cell group is selected.

See Also

For information about creating cell groups, see the description of the “Defining Cell Groups” on page 10-8.

Mathematics

MATLAB provides many functions for performing mathematical operations and analyzing data. The following list summarizes the contents of this collection:

- **Matrices and Linear Algebra** — describes matrix creation and matrix operations that are directly supported by MATLAB. Topics covered include matrix arithmetic, linear equations, eigenvalues, singular values, and matrix factorizations.
- **Polynomials and Interpolation** — describes functions for standard polynomial operations such as polynomial roots, evaluation, and differentiation. Additional topics covered include curve fitting and partial fraction expansion.
- **Data Analysis and Statistics** — describes how to organize arrays for data analysis, how to use simple descriptive statistics functions, and how to perform data pre-processing tasks in MATLAB. Additional topics covered include regression, curve fitting, data filtering, and fast Fourier transforms (FFTs).
- **Function Functions** — describes MATLAB functions that work with mathematical functions instead of numeric arrays. These function functions include plotting, optimization, zero finding, and numerical integration (quadrature).
- **Differential Equations** — describes the solution, in MATLAB, of initial value problems for ordinary differential equations (ODEs) and differential-algebraic equations (DAEs), and the solution of boundary value problems for ODEs. It also describes the solution of initial-boundary value problems for systems of parabolic and elliptic partial differential equations (PDEs). Topics covered include representing problems in MATLAB, solver syntax, and using integration parameters.
- **Sparse Matrices** — describes how to create sparse matrices in MATLAB, and how to use them in both specialized and general mathematical operations.

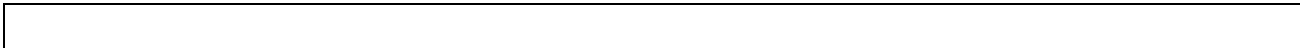

Matrices and Linear Algebra

Function Summary	11-3
Matrices in MATLAB	11-5
Creation	11-5
Addition and Subtraction	11-7
Vector Products and Transpose	11-7
Matrix Multiplication	11-9
The Identity Matrix	11-11
The Kronecker Tensor Product	11-11
Vector and Matrix Norms	11-12
Solving Linear Systems of Equations	11-13
Overview	11-13
Square Systems	11-15
Overdetermined Systems	11-15
Underdetermined Systems	11-18
Inverses and Determinants	11-21
Overview	11-21
Pseudoinverses	11-22
Cholesky, LU, and QR Factorizations	11-25
Cholesky Factorization	11-25
LU Factorization	11-26
QR Factorization	11-28
Matrix Powers and Exponentials	11-32
Eigenvalues	11-35
Singular Value Decomposition	11-39

MATLAB supports many matrix operations that are commonly used in *linear algebra*, including matrix arithmetic, linear equations, eigenvalues, singular values, and matrix factorizations. MATLAB enables you to work with entire matrices quickly and easily.

This chapter describes basic matrix operations in MATLAB and explains their use in solving problems. It includes:

Function Summary

Summarizes the MATLAB linear algebra functions

Matrices in MATLAB

Explains the use of matrices and basic matrix operations in MATLAB

Solving Linear Systems of Equations

Discusses the solution of simultaneous linear equations in MATLAB, including square systems, overdetermined systems, and underdetermined systems

Inverses and Determinants

Explains the use in MATLAB of inverses, determinants, and pseudoinverses in the solution of systems of linear equations

Cholesky, LU, and QR Factorizations

Discusses the solution in MATLAB of systems of linear equations that involve triangular matrices, using Cholesky factorization, Gaussian elimination, and orthogonalization

Matrix Powers and Exponentials

Explains the use of MATLAB notation to obtain various matrix powers and exponentials

Eigenvalues

Explains eigenvalues and describes eigenvalue decomposition in MATLAB

Singular Value Decomposition

Describes singular value decomposition of a rectangular matrix in MATLAB

Function Summary

The linear algebra functions are located in the MATLAB `matfun` directory.

Function Summary

Category	Function	Description
Matrix analysis	<code>norm</code>	Matrix or vector norm.
	<code>normest</code>	Estimate the matrix 2-norm.
	<code>rank</code>	Matrix rank.
	<code>det</code>	Determinant.
	<code>trace</code>	Sum of diagonal elements.
	<code>null</code>	Null space.
	<code>orth</code>	Orthogonalization.
	<code>rref</code>	Reduced row echelon form.
	<code>subspace</code>	Angle between two subspaces.
Linear equations	<code>\</code> and <code>/</code>	Linear equation solution.
	<code>inv</code>	Matrix inverse.
	<code>cond</code>	Condition number for inversion.
	<code>condest</code>	1-norm condition number estimate.
	<code>chol</code>	Cholesky factorization.
	<code>cholinc</code>	Incomplete Cholesky factorization.
	<code>lu</code>	LU factorization.
	<code>luinc</code>	Incomplete LU factorization.
	<code>qr</code>	Orthogonal-triangular decomposition.
	<code>lsqnonneg</code>	Nonnegative least-squares.

Function Summary (Continued)

Category	Function	Description
	pinv	Pseudoinverse.
	lscov	Least squares with known covariance.
Eigenvalues and singular values	eig	Eigenvalues and eigenvectors.
	svd	Singular value decomposition.
	eigs	A few eigenvalues.
	svds	A few singular values.
	poly	Characteristic polynomial.
	polyeig	Polynomial eigenvalue problem.
	condeig	Condition number for eigenvalues.
	hess	Hessenberg form.
	qz	QZ factorization.
	schur	Schur decomposition.
	Matrix functions	expm
logm		Matrix logarithm.
sqrtm		Matrix square root.
funm		Evaluate general matrix function.

Matrices in MATLAB

A *matrix* is a two-dimensional array of real or complex numbers. *Linear algebra* defines many matrix operations that are directly supported by MATLAB. Linear algebra includes matrix arithmetic, linear equations, eigenvalues, singular values, and matrix factorizations.

This section describes these matrix operations:

- Creation
- Addition and subtraction
- Vector products
- Matrix multiplication

It also describes the MATLAB functions you use to produce:

- An identity matrix
- The Kronecker Tensor product of two matrices
- Vector and matrix norms

Creation

Informally, the terms matrix and array are often used interchangeably. More precisely, a matrix is a two-dimensional rectangular array of real or complex numbers that represents a linear transformation. The linear algebraic operations defined on matrices have found applications in a wide variety of technical fields. (The optional Symbolic Math Toolbox extends MATLAB's capabilities to operations on various types of nonnumeric matrices.)

MATLAB has dozens of functions that create different kinds of matrices. Two of them can be used to create a pair of 3-by-3 example matrices for use throughout this chapter. The first example is symmetric.

```
A = pascal(3)
```

```
A =  
    1    1    1  
    1    2    3  
    1    3    6
```

The second example is not symmetric.

```
B = magic(3)
```

```
B =  
      8      1      6  
      3      5      7  
      4      9      2
```

Another example is a 3-by-2 rectangular matrix of random integers.

```
C = fix(10*rand(3,2))
```

```
C =  
      9      4  
      2      8  
      6      7
```

A *column vector* is an m -by-1 matrix, a *row vector* is a 1-by- n matrix and a *scalar* is a 1-by-1 matrix. The statements

```
u = [3; 1; 4]
```

```
v = [2 0 -1]
```

```
s = 7
```

produce a column vector, a row vector, and a scalar.

```
u =  
      3  
      1  
      4
```

```
v =  
      2      0     -1
```

```
s =  
      7
```

Addition and Subtraction

Addition and subtraction of matrices is defined just as it is for arrays, element-by-element. Adding A to B and then subtracting A from the result recovers B.

$$X = A + B$$

$$X = \begin{bmatrix} 9 & 2 & 7 \\ 4 & 7 & 10 \\ 5 & 12 & 8 \end{bmatrix}$$

$$Y = X - A$$

$$Y = \begin{bmatrix} 8 & 1 & 6 \\ 3 & 5 & 7 \\ 4 & 9 & 2 \end{bmatrix}$$

Addition and subtraction require both matrices to have the same dimension, or one of them be a scalar. If the dimensions are incompatible, an error results.

```
X = A + C
Error using ==> +
Matrix dimensions must agree.
```

$$w = v + s$$

$$w = \begin{bmatrix} 9 & 7 & 6 \end{bmatrix}$$

Vector Products and Transpose

A row vector and a column vector of the same length can be multiplied in either order. The result is either a scalar, the *inner* product, or a matrix, the *outer* product.

$$x = v * u$$

$$x = 2$$

$$X = u*v$$

$$X = \begin{bmatrix} 6 & 0 & -3 \\ 2 & 0 & -1 \\ 8 & 0 & -4 \end{bmatrix}$$

For real matrices, the *transpose* operation interchanges a_{ij} and a_{ji} . MATLAB uses the apostrophe (or single quote) to denote transpose. Our example matrix A is *symmetric*, so A' is equal to A. But B is not symmetric.

$$X = B'$$

$$X = \begin{bmatrix} 8 & 3 & 4 \\ 1 & 5 & 9 \\ 6 & 7 & 2 \end{bmatrix}$$

Transposition turns a row vector into a column vector.

$$x = v'$$

$$x = \begin{bmatrix} 2 \\ 0 \\ -1 \end{bmatrix}$$

If x and y are both real column vectors, the product $x*y$ is not defined, but the two products

$$x' * y$$

and

$$y' * x$$

are the same scalar. This quantity is used so frequently, it has three different names: *inner product*, *scalar product*, or *dot product*.

For a complex vector or matrix, z , the quantity z' denotes the *complex conjugate transpose*, where the sign of the complex part of each element is reversed. The unconjugated complex transpose, where the complex part of each element retains its sign, is denoted by $z \cdot '$. So if

```
z = [1+2i 3+4i]
```

then z' is

```
1-2i
3-4i
```

while $z.'$ is

```
1+2i
3+4i
```

For complex vectors, the two scalar products $x' * y$ and $y' * x$ are complex conjugates of each other and the scalar product $x' * x$ of a complex vector with itself is real.

Matrix Multiplication

Multiplication of matrices is defined in a way that reflects composition of the underlying linear transformations and allows compact representation of systems of simultaneous linear equations. The matrix product $C = AB$ is defined when the column dimension of A is equal to the row dimension of B , or when one of them is a scalar. If A is m -by- p and B is p -by- n , their product C is m -by- n . The product can actually be defined using MATLAB for loops, colon notation, and vector dot products.

```
for i = 1:m
    for j = 1:n
        C(i,j) = A(i,:)*B(:,j);
    end
end
```

MATLAB uses a single asterisk to denote matrix multiplication. The next two examples illustrate the fact that matrix multiplication is not commutative; AB is usually not equal to BA .

```
X = A*B
```

```
X =
    15    15    15
    26    38    26
    41    70    39
```

$$Y = B*A$$

$$Y = \begin{matrix} & 15 & 28 & 47 \\ & 15 & 34 & 60 \\ & 15 & 28 & 43 \end{matrix}$$

A matrix can be multiplied on the right by a column vector and on the left by a row vector.

$$x = A*u$$

$$x = \begin{matrix} 8 \\ 17 \\ 30 \end{matrix}$$

$$y = v*B$$

$$y = \begin{matrix} 12 & -7 & 10 \end{matrix}$$

Rectangular matrix multiplications must satisfy the dimension compatibility conditions.

$$X = A*C$$

$$X = \begin{matrix} 17 & 19 \\ 31 & 41 \\ 51 & 70 \end{matrix}$$

$$Y = C*A$$

Error using ==> *
Inner matrix dimensions must agree.

Anything can be multiplied by a scalar.

$$w = s*v$$

$$w = \begin{bmatrix} 14 & 0 & -7 \end{bmatrix}$$

The Identity Matrix

Generally accepted mathematical notation uses the capital letter I to denote *identity* matrices, matrices of various sizes with ones on the main diagonal and zeros elsewhere. These matrices have the property that $AI = A$ and $IA = A$ whenever the dimensions are compatible. The original version of MATLAB could not use I for this purpose because it did not distinguish between upper and lowercase letters and i already served double duty as a subscript and as the complex unit. So an English language pun was introduced. The function

`eye(m,n)`

returns an m -by- n rectangular identity matrix and `eye(n)` returns an n -by- n square identity matrix.

The Kronecker Tensor Product

The Kronecker product, $\text{kron}(X,Y)$, of two matrices is the larger matrix formed from all possible products of the elements of X with those of Y . If X is m -by- n and Y is p -by- q , then $\text{kron}(X,Y)$ is mp -by- nq . The elements are arranged in the order

$$\begin{bmatrix} X(1,1)*Y & X(1,2)*Y & \dots & X(1,n)*Y \\ & & \vdots & \\ X(m,1)*Y & X(m,2)*Y & \dots & X(m,n)*Y \end{bmatrix}$$

The Kronecker product is often used with matrices of zeros and ones to build up repeated copies of small matrices. For example, if X is the 2-by-2 matrix

$$X = \begin{bmatrix} 1 & 2 \\ 3 & 4 \end{bmatrix}$$

and $I = \text{eye}(2,2)$ is the 2-by-2 identity matrix, then the two matrices

$$\text{kron}(X,I)$$

and

$$\text{kron}(I,X)$$

are

$$\begin{bmatrix} 1 & 0 & 2 & 0 \\ 0 & 1 & 0 & 2 \\ 3 & 0 & 4 & 0 \\ 0 & 3 & 0 & 4 \end{bmatrix}$$

and

$$\begin{bmatrix} 1 & 2 & 0 & 0 \\ 3 & 4 & 0 & 0 \\ 0 & 0 & 1 & 2 \\ 0 & 0 & 3 & 4 \end{bmatrix}$$

Vector and Matrix Norms

The p -norm of a vector x

$$\|x\|_p = \left(\sum |x_i|^p \right)^{1/p}$$

is computed by `norm(x,p)`. This is defined by any value of $p > 1$, but the most common values of p are 1, 2, and ∞ . The default value is $p = 2$, which corresponds to *Euclidean length*.

```
[norm(v,1) norm(v) norm(v,inf)]
```

```
ans =
```

```
3.0000    2.2361    2.0000
```

The p -norm of a matrix A ,

$$\|A\|_p = \max_x \frac{\|Ax\|_p}{\|x\|_p}$$

can be computed for $p = 1, 2$, and ∞ by `norm(A,p)`. Again, the default value is $p = 2$.

```
[norm(C,1) norm(C) norm(C,inf)]
```

```
ans =
```

```
19.0000    14.8015    13.0000
```

Solving Linear Systems of Equations

This section describes:

- The general solution of systems of linear equations
- The solution of square systems
- The solution of overdetermined systems
- The solution of underdetermined systems

Overview

One of the most important problems in technical computing is the solution of simultaneous linear equations. In matrix notation, this problem can be stated as follows.

Given two matrices A and B , does there exist a unique matrix X so that $AX = B$ or $XA = B$?

It is instructive to consider a 1-by-1 example.

Does the equation

$$7x = 21$$

have a unique solution ?

The answer, of course, is yes. The equation has the unique solution $x = 3$. The solution is easily obtained by *division*.

$$x = 21/7 = 3$$

The solution is *not* ordinarily obtained by computing the inverse of 7, that is $7^{-1} = 0.142857\dots$, and then multiplying 7^{-1} by 21. This would be more work and, if 7^{-1} is represented to a finite number of digits, less accurate. Similar considerations apply to sets of linear equations with more than one unknown; MATLAB solves such equations without computing the inverse of the matrix.

Although it is not standard mathematical notation, MATLAB uses the division terminology familiar in the scalar case to describe the solution of a general system of simultaneous equations. The two division symbols, *slash*, $/$, and

backslash, \backslash , are used for the two situations where the unknown matrix appears on the left or right of the coefficient matrix.

$X = A \backslash B$ Denotes the solution to the matrix equation $AX = B$.

$X = B/A$ Denotes the solution to the matrix equation $XA = B$.

You can think of “dividing” both sides of the equation $AX = B$ or $XA = B$ by A . The coefficient matrix A is always in the “denominator.”

The dimension compatibility conditions for $X = A \backslash B$ require the two matrices A and B to have the same number of rows. The solution X then has the same number of columns as B and its row dimension is equal to the column dimension of A . For $X = B/A$, the roles of rows and columns are interchanged.

In practice, linear equations of the form $AX = B$ occur more frequently than those of the form $XA = B$. Consequently, backslash is used far more frequently than slash. The remainder of this section concentrates on the backslash operator; the corresponding properties of the slash operator can be inferred from the identity

$$(B/A)' = (A' \backslash B')$$

The coefficient matrix A need not be square. If A is m -by- n , there are three cases.

$m = n$ Square system. Seek an exact solution.

$m > n$ Overdetermined system. Find a least squares solution.

$m < n$ Underdetermined system. Find a basic solution with at most m nonzero components.

The backslash operator employs different algorithms to handle different kinds of coefficient matrices. The various cases, which are diagnosed automatically by examining the coefficient matrix, include:

- Permutations of triangular matrices
- Symmetric, positive definite matrices
- Square, nonsingular matrices
- Rectangular, overdetermined systems
- Rectangular, underdetermined systems

Square Systems

The most common situation involves a square coefficient matrix A and a single right-hand side column vector b . The solution, $x = A \setminus b$, is then the same size as b . For example,

$$x = A \setminus u$$

$$x = \begin{bmatrix} 10 \\ -12 \\ 5 \end{bmatrix}$$

It can be confirmed that $A * x$ is exactly equal to u .

If A and B are square and the same size, then $X = A \setminus B$ is also that size.

$$X = A \setminus B$$

$$X = \begin{bmatrix} 19 & -3 & -1 \\ -17 & 4 & 13 \\ 6 & 0 & -6 \end{bmatrix}$$

It can be confirmed that $A * X$ is exactly equal to B .

Both of these examples have exact, integer solutions. This is because the coefficient matrix was chosen to be `pascal(3)`, which has a determinant equal to one. A later section considers the effects of roundoff error inherent in more realistic computation.

A square matrix A is *singular* if it does not have linearly independent columns. If A is singular, the solution to $AX = B$ either does not exist, or is not unique. The backslash operator, $A \setminus B$, issues a warning if A is nearly singular and raises an error condition if exact singularity is detected.

Overdetermined Systems

Overdetermined systems of simultaneous linear equations are often encountered in various kinds of curve fitting to experimental data. Here is a hypothetical example. A quantity y is measured at several different values of time, t , to produce the following observations.

t	y
0.0	0.82
0.3	0.72
0.8	0.63
1.1	0.60
1.6	0.55
2.3	0.50

This data can be entered into MATLAB with the statements

```
t = [0 .3 .8 1.1 1.6 2.3]';
y = [.82 .72 .63 .60 .55 .50]';
```

The data can be modeled with a decaying exponential function.

$$y(t) \approx c_1 + c_2 e^{-t}$$

This equation says that the vector y should be approximated by a linear combination of two other vectors, one the constant vector containing all ones and the other the vector with components e^{-t} . The unknown coefficients, c_1 and c_2 , can be computed by doing a *least squares fit*, which minimizes the sum of the squares of the deviations of the data from the model. There are six equations in two unknowns, represented by the 6-by-2 matrix.

```
E = [ones(size(t)) exp(-t)]
```

```
E =
    1.0000    1.0000
    1.0000    0.7408
    1.0000    0.4493
    1.0000    0.3329
    1.0000    0.2019
    1.0000    0.1003
```

The least squares solution is found with the backslash operator.

```
c = E\y
c =
    0.4760
    0.3413
```

In other words, the least squares fit to the data is

$$y(t) \approx 0.4760 + 0.3413 e^{-t}$$

The following statements evaluate the model at regularly spaced increments in t , and then plot the result, together with the original data.

```
T = (0:0.1:2.5)';
Y = [ones(size(T)) exp(-T)]*c;
plot(T,Y, '- ',t,y, 'o')
```

You can see that $E*c$ is not exactly equal to y , but that the difference might well be less than measurement errors in the original data.

A rectangular matrix A is *rank deficient* if it does not have linearly independent columns. If A is rank deficient, the least squares solution to $AX = B$ is not unique. The backslash operator, $A \setminus B$, issues a warning if A is rank deficient and produces a *basic* solution that has as few nonzero elements as possible.

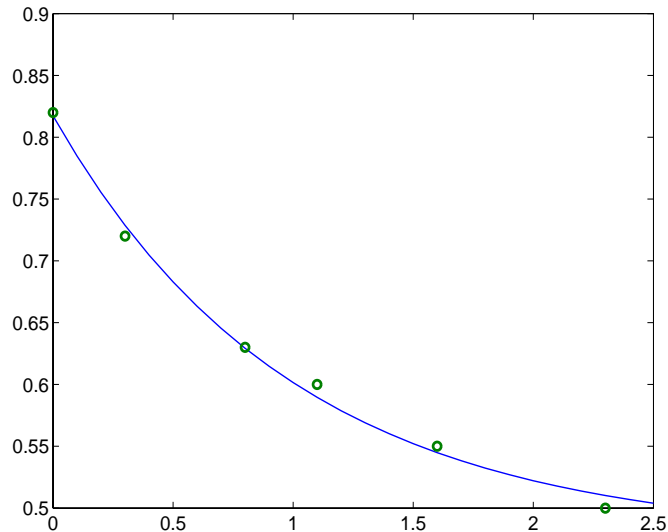

Underdetermined Systems

Underdetermined linear systems involve more unknowns than equations. When they are accompanied by additional constraints, they are the purview of *linear programming*. By itself, the backslash operator deals only with the unconstrained system. The solution is never unique. MATLAB finds a *basic* solution, which has at most m nonzero components, but even this may not be unique. The particular solution actually computed is determined by the QR factorization with column pivoting (see a later section on the QR factorization).

Here is a small, random example.

```
R = fix(10*rand(2,4))

R =
     6     8     7     3
     3     5     4     1

b = fix(10*rand(2,1))

b =
     1
     2
```

The linear system $Rx = b$ involves two equations in four unknowns. Since the coefficient matrix contains small integers, it is appropriate to use the format command to display the solution in *rational* format. The particular solution is obtained with

```
format rat

p = R\b

p =
     0
    5/7
     0
   -11/7
```

One of the nonzero components is $p(2)$ because $R(:, 2)$ is the column of R with largest norm. The other nonzero component is $p(4)$ because $R(:, 4)$ dominates after $R(:, 2)$ is eliminated.

The complete solution to the overdetermined (*overdetermined?*) system can be characterized by adding an arbitrary vector from the null space, which can be found using the `null` function with an option requesting a “rational” basis.

```
Z = null(R, 'r')

Z =
   -1/2   -7/6
   -1/2    1/2
```

$$\begin{array}{cc} 1 & 0 \\ 0 & 1 \end{array}$$

It can be confirmed that $R*Z$ is zero and that any vector x where

$$x = p + Z*q$$

for an arbitrary vector q satisfies $R*x = b$.

Inverses and Determinants

This section provides:

- An overview of the use of inverses and determinants for solving square nonsingular systems of linear equations
- A discussion of the Moore-Penrose pseudoinverse for solving rectangular systems of linear equations

Overview

If A is square and nonsingular, the equations $AX = I$ and $XA = I$ have the same solution, X . This solution is called the *inverse* of A , is denoted by A^{-1} , and is computed by the function `inv`. The *determinant* of a matrix is useful in theoretical considerations and some types of symbolic computation, but its scaling and roundoff error properties make it far less satisfactory for numeric computation. Nevertheless, the function `det` computes the determinant of a square matrix.

```
A = pascal(3)
```

```
A =
     1     1     1
     1     2     3
     1     3     6
```

```
d = det(A)
X = inv(A)
```

```
d =
     1
```

```
X =
     3    -3     1
    -3     5    -2
     1    -2     1
```

Again, because A is symmetric, has integer elements, and has determinant equal to one, so does its inverse. On the other hand,

```
B = magic(3)
```

```
B =
      8      1      6
      3      5      7
      4      9      2

d = det(B)
X = inv(B)

d =
    -360

X =
    0.1472   -0.1444    0.0639
   -0.0611    0.0222    0.1056
   -0.0194    0.1889   -0.1028
```

Closer examination of the elements of X , or use of `format rat`, would reveal that they are integers divided by 360.

If A is square and nonsingular, then without roundoff error, $X = \text{inv}(A)*B$ would theoretically be the same as $X = A\backslash B$ and $Y = B*\text{inv}(A)$ would theoretically be the same as $Y = B/A$. But the computations involving the backslash and slash operators are preferable because they require less computer time, less memory, and have better error detection properties.

Pseudoinverses

Rectangular matrices do not have inverses or determinants. At least one of the equations $AX = I$ and $XA = I$ does not have a solution. A partial replacement for the inverse is provided by the *Moore-Penrose pseudoinverse*, which is computed by the `pinv` function.

```
X = pinv(C)

X =
    0.1159   -0.0729    0.0171
   -0.0534    0.1152    0.0418
```

The matrix

```
Q = X*C
```

$$Q = \begin{bmatrix} 1.0000 & 0.0000 \\ 0.0000 & 1.0000 \end{bmatrix}$$

is the 2-by-2 identity, but the matrix

$$P = C * X$$

$$P = \begin{bmatrix} 0.8293 & -0.1958 & 0.3213 \\ -0.1958 & 0.7754 & 0.3685 \\ 0.3213 & 0.3685 & 0.3952 \end{bmatrix}$$

is not the 3-by-3 identity. However, P acts like an identity on a portion of the space in the sense that P is symmetric, $P * C$ is equal to C and $X * P$ is equal to X .

If A is m -by- n with $m > n$ and full rank n , then each of the three statements

$$\begin{aligned} x &= A \backslash b \\ x &= \text{pinv}(A) * b \\ x &= \text{inv}(A' * A) * A' * b \end{aligned}$$

theoretically computes the same least squares solution x , although the backslash operator does it faster.

However, if A does not have full rank, the solution to the least squares problem is not unique. There are many vectors x that minimize

$$\text{norm}(A * x - b)$$

The solution computed by $x = A \backslash b$ is a *basic* solution; it has at most r nonzero components, where r is the rank of A . The solution computed by $x = \text{pinv}(A) * b$ is the *minimal norm* solution because it minimizes $\text{norm}(x)$. An attempt to compute a solution with $x = \text{inv}(A' * A) * A' * b$ fails because $A' * A$ is singular.

Here is an example to illustrate the various solutions.

$$A = \begin{bmatrix} 1 & 2 & 3 \\ 4 & 5 & 6 \\ 7 & 8 & 9 \\ 10 & 11 & 12 \end{bmatrix}$$

does not have full rank. Its second column is the average of the first and third columns. If

```
b = A(:,2)
```

is the second column, then an obvious solution to $A*x = b$ is $x = [0 \ 1 \ 0]'$. But none of the approaches computes that x . The backslash operator gives

```
x = A\b
```

```
Warning: Rank deficient, rank = 2.
```

```
x =  
    0.5000  
    0  
    0.5000
```

This solution has two nonzero components. The pseudoinverse approach gives

```
y = pinv(A)*b
```

```
y =  
    0.3333  
    0.3333  
    0.3333
```

There is no warning about rank deficiency. But $\text{norm}(y) = 0.5774$ is less than $\text{norm}(x) = 0.7071$. Finally

```
z = inv(A'*A)*A'*b
```

fails completely.

```
Warning: Matrix is singular to working precision.
```

```
z =  
    Inf  
    Inf  
    Inf
```

Cholesky, LU, and QR Factorizations

MATLAB's linear equation capabilities are based on three basic matrix factorizations:

- Cholesky factorization for symmetric, positive definite matrices
- LU factorization (Gaussian elimination) for general square matrices
- QR (orthogonal) for rectangular matrices

These three factorizations are available through the `chol`, `lu`, and `qr` functions.

All three of these factorizations make use of *triangular* matrices where all the elements either above or below the diagonal are zero. Systems of linear equations involving triangular matrices are easily and quickly solved using either *forward* or *back substitution*.

Cholesky Factorization

The Cholesky factorization expresses a symmetric matrix as the product of a triangular matrix and its transpose

$$A = R'R$$

where R is an upper triangular matrix.

Not all symmetric matrices can be factored in this way; the matrices that have such a factorization are said to be *positive definite*. This implies that all the diagonal elements of A are positive and that the offdiagonal elements are “not too big.” The Pascal matrices provide an interesting example. Throughout this chapter, our example matrix A has been the 3-by-3 Pascal matrix. Let's temporarily switch to the 6-by-6.

$$A = \text{pascal}(6)$$

$$A = \begin{array}{cccccc} 1 & 1 & 1 & 1 & 1 & 1 \\ 1 & 2 & 3 & 4 & 5 & 6 \\ 1 & 3 & 6 & 10 & 15 & 21 \\ 1 & 4 & 10 & 20 & 35 & 56 \\ 1 & 5 & 15 & 35 & 70 & 126 \\ 1 & 6 & 21 & 56 & 126 & 252 \end{array}$$

The elements of A are binomial coefficients. Each element is the sum of its north and west neighbors. The Cholesky factorization is

$$R = \text{chol}(A)$$

$$R = \begin{matrix} & 1 & 1 & 1 & 1 & 1 & 1 \\ & 0 & 1 & 2 & 3 & 4 & 5 \\ & 0 & 0 & 1 & 3 & 6 & 10 \\ & 0 & 0 & 0 & 1 & 4 & 10 \\ & 0 & 0 & 0 & 0 & 1 & 5 \\ & 0 & 0 & 0 & 0 & 0 & 1 \end{matrix}$$

The elements are again binomial coefficients. The fact that $R' * R$ is equal to A demonstrates an identity involving sums of products of binomial coefficients.

Note The Cholesky factorization also applies to complex matrices. Any complex matrix which has a Cholesky factorization satisfies $A' = A$ and is said to be *Hermitian positive definite*.

The Cholesky factorization allows the linear system

$$Ax = b$$

to be replaced by

$$R'Rx = b$$

Because the backslash operator recognizes triangular systems, this can be solved in MATLAB quickly with

$$x = R \setminus (R' \setminus b)$$

If A is n -by- n , the computational complexity of $\text{chol}(A)$ is $O(n^3)$, but the complexity of the subsequent backslash solutions is only $O(n^2)$.

LU Factorization

LU factorization, or Gaussian elimination, expresses any square matrix A as the product of a permutation of a lower triangular matrix and an upper triangular matrix

$$A = LU$$

where L is a permutation of a lower triangular matrix with ones on its diagonal and U is an upper triangular matrix.

The permutations are necessary for both theoretical and computational reasons. The matrix

$$\begin{bmatrix} 0 & 1 \\ 1 & 0 \end{bmatrix}$$

cannot be expressed as the product of triangular matrices without interchanging its two rows. Although the matrix

$$\begin{bmatrix} \varepsilon & 1 \\ 1 & 0 \end{bmatrix}$$

can be expressed as the product of triangular matrices, when ε is small the elements in the factors are large and magnify errors, so even though the permutations are not strictly necessary, they are desirable. *Partial pivoting* ensures that the elements of L are bounded by one in magnitude and that the elements of U are not much larger than those of A .

For example

$$[L,U] = \text{lu}(B)$$

$L =$

$$\begin{array}{ccc} 1.0000 & 0 & 0 \\ 0.3750 & 0.5441 & 1.0000 \\ 0.5000 & 1.0000 & 0 \end{array}$$

$U =$

$$\begin{array}{ccc} 8.0000 & 1.0000 & 6.0000 \\ 0 & 8.5000 & -1.0000 \\ 0 & 0 & 5.2941 \end{array}$$

The LU factorization of A allows the linear system

$$A \cdot x = b$$

to be solved quickly with

$$x = U \setminus (L \setminus b)$$

Determinants and inverses are computed from the LU factorization using

$$\det(A) = \det(L) \cdot \det(U)$$

and

$$\text{inv}(A) = \text{inv}(U) \cdot \text{inv}(L)$$

You can also compute the determinants using $\det(A) = \text{prod}(\text{diag}(U))$, though the signs of the determinants may be reversed.

QR Factorization

An *orthogonal* matrix, or a matrix with *orthonormal columns*, is a real matrix whose columns all have unit length and are perpendicular to each other. If Q is orthogonal, then

$$Q'Q = 1$$

The simplest orthogonal matrices are two-dimensional coordinate rotations.

$$\begin{bmatrix} \cos(\theta) & \sin(\theta) \\ -\sin(\theta) & \cos(\theta) \end{bmatrix}$$

For complex matrices, the corresponding term is *unitary*. Orthogonal and unitary matrices are desirable for numerical computation because they preserve length, preserve angles, and do not magnify errors.

The orthogonal, or QR, factorization expresses any rectangular matrix as the product of an orthogonal or unitary matrix and an upper triangular matrix. A column permutation may also be involved.

$$A = QR$$

or

$$AP = QR$$

where Q is orthogonal or unitary, R is upper triangular, and P is a permutation.

There are four variants of the QR factorization— full or economy size, and with or without column permutation.

Overdetermined linear systems involve a rectangular matrix with more rows than columns, that is m -by- n with $m > n$. The *full* size QR factorization produces a square, m -by- m orthogonal Q and a rectangular m -by- n upper triangular R .

$$[Q,R] = \text{qr}(C)$$

$$Q = \begin{bmatrix} -0.8182 & 0.3999 & -0.4131 \\ -0.1818 & -0.8616 & -0.4739 \\ -0.5455 & -0.3126 & 0.7777 \end{bmatrix}$$

$$R = \begin{bmatrix} -11.0000 & -8.5455 \\ 0 & -7.4817 \\ 0 & 0 \end{bmatrix}$$

In many cases, the last $m - n$ columns of Q are not needed because they are multiplied by the zeros in the bottom portion of R . So the *economy* size QR factorization produces a rectangular, m -by- n Q with orthonormal columns and a square n -by- n upper triangular R . For our 3-by-2 example, this is not much of a saving, but for larger, highly rectangular matrices, the savings in both time and memory can be quite important.

$$[Q,R] = \text{qr}(C,0)$$

$$Q = \begin{bmatrix} -0.8182 & 0.3999 \\ -0.1818 & -0.8616 \\ -0.5455 & -0.3126 \end{bmatrix}$$

$$R = \begin{bmatrix} -11.0000 & -8.5455 \\ 0 & -7.4817 \end{bmatrix}$$

In contrast to the LU factorization, the QR factorization does not require any pivoting or permutations. But an optional column permutation, triggered by the presence of a third output argument, is useful for detecting singularity or rank deficiency. At each step of the factorization, the column of the remaining unfactored matrix with largest norm is used as the basis for that step. This ensures that the diagonal elements of R occur in decreasing order and that any linear dependence among the columns is almost certainly be revealed by examining these elements. For our small example, the second column of C has a larger norm than the first, so the two columns are exchanged.

$$[Q,R,P] = \text{qr}(C)$$

$$Q = \begin{bmatrix} -0.3522 & 0.8398 & -0.4131 \\ -0.7044 & -0.5285 & -0.4739 \\ -0.6163 & 0.1241 & 0.7777 \end{bmatrix}$$

$$R = \begin{bmatrix} -11.3578 & -8.2762 \\ 0 & 7.2460 \\ 0 & 0 \end{bmatrix}$$

$$P = \begin{bmatrix} 0 & 1 \\ 1 & 0 \end{bmatrix}$$

When the economy size and column permutations are combined, the third output argument is a permutation vector, rather than a permutation matrix.

$$[Q,R,p] = \text{qr}(C,0)$$

$$Q = \begin{bmatrix} -0.3522 & 0.8398 \\ -0.7044 & -0.5285 \\ -0.6163 & 0.1241 \end{bmatrix}$$

$$R = \begin{bmatrix} -11.3578 & -8.2762 \\ 0 & 7.2460 \end{bmatrix}$$

$$p = \frac{1}{2} \|Ax - b\|_2$$

The QR factorization transforms an overdetermined linear system into an equivalent triangular system. The expression

$$\|Ax - b\|_2$$

is equal to

$$\|QRx - b\|_2$$

Multiplication by orthogonal matrices preserves the Euclidean norm, so this expression is also equal to

$$\|Rx - y\|_2$$

where $y = Q^T b$. Since the last $m-n$ rows of R are zero, this expression breaks into two pieces

$$\|R(1:n, 1:n)x - y(1:n)\|_2$$

and

$$\|y(n+1:m)\|_2$$

When A has full rank, it is possible to solve for x so that the first of these expressions is zero. Then the second expression gives the norm of the residual. When A does not have full rank, the triangular structure of R makes it possible to find a basic solution to the least squares problem.

Matrix Powers and Exponentials

This section tells you how to obtain the following matrix powers and exponentials in MATLAB:

- Positive integer
- Inverse and fractional
- Element-by-element
- Exponentials

Positive Integer Powers

If A is a square matrix and p is a positive integer, then A^p effectively multiplies A by itself $p-1$ times.

$$X = A^2$$

$$X = \begin{bmatrix} 3 & 6 & 10 \\ 6 & 14 & 25 \\ 10 & 25 & 46 \end{bmatrix}$$

Inverse and Fractional Powers

If A is square and nonsingular, then $A^{(-p)}$ effectively multiplies $\text{inv}(A)$ by itself $p-1$ times.

$$Y = B^{(-3)}$$

$$Y = \begin{bmatrix} 0.0053 & -0.0068 & 0.0018 \\ -0.0034 & 0.0001 & 0.0036 \\ -0.0016 & 0.0070 & -0.0051 \end{bmatrix}$$

Fractional powers, like $A^{(2/3)}$, are also permitted; the results depend upon the distribution of the eigenvalues of the matrix.

Element-by-Element Powers

The .^{\wedge} operator produces element-by-element powers. For example,

$$X = A.^2$$

$$A = \begin{pmatrix} 1 & 1 & 1 \\ 1 & 4 & 9 \\ 1 & 9 & 36 \end{pmatrix}$$

Exponentials

The function

$$\text{sqrtm}(A)$$

computes $A^{(1/2)}$ by a more accurate algorithm. The `m` in `sqrtm` distinguishes this function from `sqrt(A)` which, like $A^{(1/2)}$, does its job element-by-element.

A system of linear, constant coefficient, ordinary differential equations can be written

$$dx/dt = Ax$$

where $x = x(t)$ is a vector of functions of t and A is a matrix independent of t . The solution can be expressed in terms of the *matrix exponential*,

$$x(t) = e^{tA}x(0)$$

The function

$$\text{expm}(A)$$

computes the matrix exponential. An example is provided by the 3-by-3 coefficient matrix

$$A = \begin{pmatrix} 0 & -6 & -1 \\ 6 & 2 & -16 \\ -5 & 20 & -10 \end{pmatrix}$$

and the initial condition, $x(0)$

$$x0 = \begin{pmatrix} 1 \\ 1 \\ 1 \end{pmatrix}$$

The matrix exponential is used to compute the solution, $x(t)$, to the differential equation at 101 points on the interval $0 \leq t \leq 1$ with

```
X = [];  
for t = 0:.01:1  
    X = [X expm(t*A)*x0];  
end
```

A three-dimensional phase plane plot obtained with

```
plot3(X(1,:),X(2,:),X(3,:), '-o')
```

shows the solution spiraling in towards the origin. This behavior is related to the eigenvalues of the coefficient matrix, which are discussed in the next section.

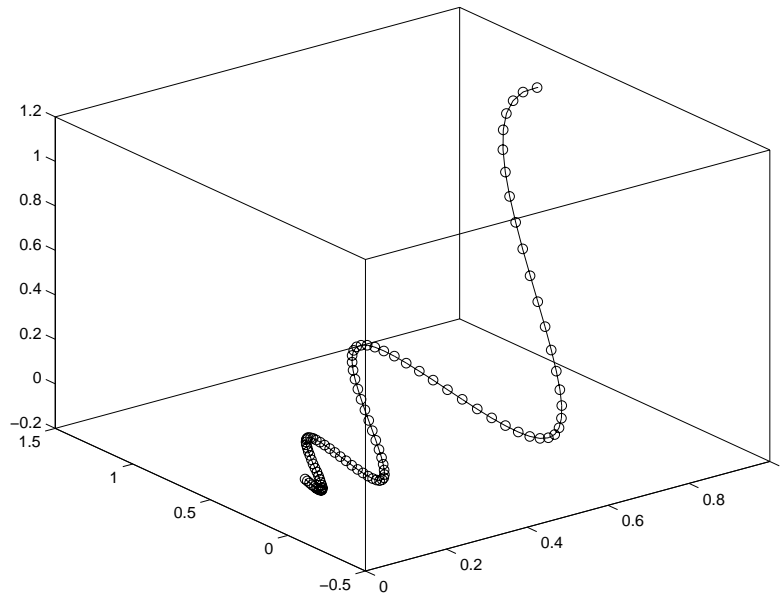

Eigenvalues

An *eigenvalue* and *eigenvector* of a square matrix A are a scalar λ and a nonzero vector v that satisfy

$$Av = \lambda v$$

This section explains:

- Eigenvalue decomposition
- Problems associated with defective (not diagonalizable) matrices
- The use of Schur decomposition to avoid problems associated with eigenvalue decomposition

Eigenvalue Decomposition

With the eigenvalues on the diagonal of a diagonal matrix Λ and the corresponding eigenvectors forming the columns of a matrix V , we have

$$AV = V\Lambda$$

If V is nonsingular, this becomes the *eigenvalue decomposition*

$$A = V\Lambda V^{-1}$$

A good example is provided by the coefficient matrix of the ordinary differential equation in the previous section.

$$A = \begin{array}{ccc} 0 & -6 & -1 \\ 6 & 2 & -16 \\ -5 & 20 & -10 \end{array}$$

The statement

$$\text{lambda} = \text{eig}(A)$$

produces a column vector containing the eigenvalues. For this matrix, the eigenvalues are complex.

$$\text{lambda} = \begin{array}{l} -3.0710 \\ -2.4645+17.6008i \\ -2.4645-17.6008i \end{array}$$

The real part of each of the eigenvalues is negative, so $e^{\lambda t}$ approaches zero as t increases. The nonzero imaginary part of two of the eigenvalues, $\pm\omega$, contributes the oscillatory component, $\sin(\omega t)$, to the solution of the differential equation.

With two output arguments, `eig` computes the eigenvectors and stores the eigenvalues in a diagonal matrix.

$$[V,D] = \text{eig}(A)$$

V =

$$\begin{array}{rcccc} -0.8326 & & 0.2003 - 0.1394i & 0.2003 + 0.1394i \\ -0.3553 & & -0.2110 - 0.6447i & -0.2110 + 0.6447i \\ -0.4248 & & -0.6930 & -0.6930 \end{array}$$

D =

$$\begin{array}{rccc} -3.0710 & & 0 & 0 \\ 0 & & -2.4645+17.6008i & 0 \\ 0 & & 0 & -2.4645-17.6008i \end{array}$$

The first eigenvector is real and the other two vectors are complex conjugates of each other. All three vectors are normalized to have Euclidean length, `norm(v,2)`, equal to one.

The matrix $V \cdot D \cdot \text{inv}(V)$, which can be written more succinctly as $V \cdot D / V$, is within roundoff error of A. And, $\text{inv}(V) \cdot A \cdot V$, or $V \setminus A \cdot V$, is within roundoff error of D.

Defective Matrices

Some matrices do not have an eigenvector decomposition. These matrices are *defective*, or *not diagonalizable*. For example,

A =

$$\begin{array}{rccc} 6 & 12 & 19 \\ -9 & -20 & -33 \\ 4 & 9 & 15 \end{array}$$

For this matrix

$$[V,D] = \text{eig}(A)$$

produces

$$V = \begin{bmatrix} -0.4741 & -0.4082 & -0.4082 \\ 0.8127 & 0.8165 & 0.8165 \\ -0.3386 & -0.4082 & -0.4082 \end{bmatrix}$$

$$D = \begin{bmatrix} -1.0000 & 0 & 0 \\ 0 & 1.0000 & 0 \\ 0 & 0 & 1.0000 \end{bmatrix}$$

There is a double eigenvalue at $\lambda = 1$. The second and third columns of V are the same. For this matrix, a full set of linearly independent eigenvectors does not exist.

The optional Symbolic Math Toolbox extends MATLAB's capabilities by connecting to Maple, a powerful computer algebra system. One of the functions provided by the toolbox computes the Jordan Canonical Form. This is appropriate for matrices like our example, which is 3-by-3 and has exactly known, integer elements.

$$[X,J] = \text{jordan}(A)$$

$$X = \begin{bmatrix} -1.7500 & 1.5000 & 2.7500 \\ 3.0000 & -3.0000 & -3.0000 \\ -1.2500 & 1.5000 & 1.2500 \end{bmatrix}$$

$$J = \begin{bmatrix} -1 & 0 & 0 \\ 0 & 1 & 1 \\ 0 & 0 & 1 \end{bmatrix}$$

The Jordan Canonical Form is an important theoretical concept, but it is not a reliable computational tool for larger matrices, or for matrices whose elements are subject to roundoff errors and other uncertainties.

Schur Decomposition in MATLAB Matrix Computations

MATLAB's advanced matrix computations do not require eigenvalue decompositions. They are based, instead, on the *Schur decomposition*

$$A = USU^T$$

where U is an orthogonal matrix and S is a block upper triangular matrix with 1-by-1 and 2-by-2 blocks on the diagonal. The eigenvalues are revealed by the diagonal elements and blocks of S , while the columns of U provide a basis with much better numerical properties than a set of eigenvectors. The Schur decomposition of our defective example is

$$[U, S] = \text{schur}(A)$$

$U =$

$$\begin{array}{ccc} 0.4741 & -0.6571 & 0.5861 \\ -0.8127 & -0.0706 & 0.5783 \\ 0.3386 & 0.7505 & 0.5675 \end{array}$$

$S =$

$$\begin{array}{ccc} -1.0000 & 21.3737 & 44.4161 \\ & 0 & 1.0081 & 0.6095 \\ & 0 & -0.0001 & 0.9919 \end{array}$$

The double eigenvalue is contained in the lower 2-by-2 block of S .

Note If A is complex, `schur` returns the complex Schur form, which is upper triangular with the eigenvalues of A on the diagonal.

Singular Value Decomposition

A *singular value* and corresponding *singular vectors* of a rectangular matrix A are a scalar σ and a pair of vectors u and v that satisfy

$$Av = \sigma u$$

$$A^T u = \sigma v$$

With the singular values on the diagonal of a diagonal matrix Σ and the corresponding singular vectors forming the columns of two orthogonal matrices U and V , we have

$$AV = U\Sigma$$

$$A^T U = V\Sigma$$

Since U and V are orthogonal, this becomes the *singular value decomposition*

$$A = U\Sigma V^T$$

The full singular value decomposition of an m -by- n matrix involves an m -by- m U , an m -by- n Σ , and an n -by- n V . In other words, U and V are both square and Σ is the same size as A . If A has many more rows than columns, the resulting U can be quite large, but most of its columns are multiplied by zeros in Σ . In this situation, the *economy sized* decomposition saves both time and storage by producing an m -by- n U , an n -by- n Σ and the same V .

The eigenvalue decomposition is the appropriate tool for analyzing a matrix when it represents a mapping from a vector space into itself, as it does for an ordinary differential equation. On the other hand, the singular value decomposition is the appropriate tool for analyzing a mapping from one vector space into another vector space, possibly with a different dimension. Most systems of simultaneous linear equations fall into this second category.

If A is square, symmetric, and positive definite, then its eigenvalue and singular value decompositions are the same. But, as A departs from symmetry and positive definiteness, the difference between the two decompositions increases. In particular, the singular value decomposition of a real matrix is always real, but the eigenvalue decomposition of a real, nonsymmetric matrix might be complex.

For the example matrix

$$A = \begin{bmatrix} 9 & 4 \\ 6 & 8 \\ 2 & 7 \end{bmatrix}$$

the full singular value decomposition is

$$[U, S, V] = \text{svd}(A)$$

$$U = \begin{bmatrix} -0.6105 & 0.7174 & 0.3355 \\ -0.6646 & -0.2336 & -0.7098 \\ -0.4308 & -0.6563 & 0.6194 \end{bmatrix}$$

$$S = \begin{bmatrix} 14.9359 & & 0 \\ & 0 & 5.1883 \\ & & 0 & 0 \end{bmatrix}$$

$$V = \begin{bmatrix} -0.6925 & 0.7214 \\ -0.7214 & -0.6925 \end{bmatrix}$$

You can verify that $U*S*V'$ is equal to A to within roundoff error. For this small problem, the economy size decomposition is only slightly smaller.

$$[U, S, V] = \text{svd}(A, 0)$$

$$U = \begin{bmatrix} -0.6105 & 0.7174 \\ -0.6646 & -0.2336 \\ -0.4308 & -0.6563 \end{bmatrix}$$

$$S = \begin{bmatrix} 14.9359 & & 0 \\ & 0 & 5.1883 \end{bmatrix}$$

$$V = \begin{bmatrix} -0.6925 & 0.7214 \\ -0.7214 & -0.6925 \end{bmatrix}$$

Again, $U*S*V'$ is equal to A to within roundoff error.

Polynomials and Interpolation

Polynomials	12-3
Polynomial Function Summary	12-3
Representing Polynomials	12-4
Polynomial Roots	12-4
Characteristic Polynomials	12-5
Polynomial Evaluation	12-5
Convolution and Deconvolution	12-6
Polynomial Derivatives	12-6
Polynomial Curve Fitting	12-7
Partial Fraction Expansion	12-8
Interpolation	12-10
Interpolation Function Summary	12-10
One-Dimensional Interpolation	12-11
Two-Dimensional Interpolation	12-13
Comparing Interpolation Methods	12-14
Interpolation and Multidimensional Arrays	12-16
Triangulation and Interpolation of Scattered Data	12-19
Tessellation and Interpolation of Scattered Data in Higher Dimensions	12-27
Selected Bibliography	12-38

This chapter introduces MATLAB functions that enable you to work with polynomials and interpolate one-, two-, and multi-dimensional data. It includes:

Polynomials

Functions for standard polynomial operations. Additional topics include curve fitting and partial fraction expansion.

Interpolation

Two- and multi-dimensional interpolation techniques, taking into account speed, memory, and smoothness considerations.

Polynomials

This section provides:

- A summary of the MATLAB polynomial functions
- Instructions for representing polynomials in MATLAB

It also describes the MATLAB polynomial functions that:

- Calculate the roots of a polynomial
- Calculate the coefficients of the characteristic polynomial of a matrix
- Evaluate a polynomial at a specified value
- Convolve (multiply) and deconvolve (divide) polynomials
- Compute the derivative of a polynomial
- Fit a polynomial to a set of data
- Convert between partial fraction expansion and polynomial coefficients

Polynomial Function Summary

MATLAB provides functions for standard polynomial operations, such as polynomial roots, evaluation, and differentiation. In addition, there are functions for more advanced applications, such as curve fitting and partial fraction expansion.

The polynomial functions reside in the MATLAB `polyfun` directory.

Polynomial Function Summary

Function	Description
<code>conv</code>	Multiply polynomials.
<code>deconv</code>	Divide polynomials.
<code>poly</code>	Polynomial with specified roots.
<code>polyder</code>	Polynomial derivative.
<code>polyfit</code>	Polynomial curve fitting.
<code>polyval</code>	Polynomial evaluation.

Polynomial Function Summary (Continued)

Function	Description
polyvalm	Matrix polynomial evaluation.
residue	Partial-fraction expansion (residues).
roots	Find polynomial roots.

The Symbolic Math Toolbox contains additional specialized support for polynomial operations.

Representing Polynomials

MATLAB represents polynomials as row vectors containing coefficients ordered by descending powers. For example, consider the equation

$$p(x) = x^3 - 2x - 5$$

This is the celebrated example Wallis used when he first represented Newton's method to the French Academy. To enter this polynomial into MATLAB, use

```
p = [1 0 -2 -5];
```

Polynomial Roots

The roots function calculates the roots of a polynomial.

```
r = roots(p)
```

```
r =
    2.0946
   -1.0473 + 1.1359i
   -1.0473 - 1.1359i
```

By convention, MATLAB stores roots in column vectors. The function poly returns to the polynomial coefficients.

```
p2 = poly(r)
```

```
p2 =
    1    8.8818e-16   -2   -5
```

`poly` and `roots` are inverse functions, up to ordering, scaling, and roundoff error.

Characteristic Polynomials

The `poly` function also computes the coefficients of the characteristic polynomial of a matrix.

```
A = [1.2 3 -0.9; 5 1.75 6; 9 0 1];
poly(A)

ans =
    1.0000   -3.9500   -1.8500  -163.2750
```

The roots of this polynomial, computed with `roots`, are the *characteristic roots*, or eigenvalues, of the matrix `A`. (Use `eig` to compute the eigenvalues of a matrix directly.)

Polynomial Evaluation

The `polyval` function evaluates a polynomial at a specified value. To evaluate `p` at $s = 5$, use

```
polyval(p,5)

ans =
    110
```

It is also possible to evaluate a polynomial in a matrix sense. In this case $p(s) = s^3 - 2s - 5$ becomes $p(X) = X^3 - 2X - 5I$, where X is a square matrix and I is the identity matrix. For example, create a square matrix `X` and evaluate the polynomial `p` at `X`.

```
X = [2 4 5; -1 0 3; 7 1 5];
Y = polyvalm(p,X)

Y =
    377    179    439
    111     81    136
    490    253    639
```

Convolution and Deconvolution

Polynomial multiplication and division correspond to the operations convolution and deconvolution. The functions `conv` and `deconv` implement these operations.

Consider the polynomials $a(s) = s^2 + 2s + 3$ and $b(s) = 4s^2 + 5s + 6$. To compute their product,

```
a = [1 2 3]; b = [4 5 6];
c = conv(a,b)
```

```
c =
     4     13     28     27     18
```

Use deconvolution to divide $a(s)$ back out of the product.

```
[q,r] = deconv(c,a)
```

```
q =
     4     5     6
```

```
r =
     0     0     0     0     0
```

Polynomial Derivatives

The `polyder` function computes the derivative of any polynomial. To obtain the derivative of the polynomial $p = [1 \ 0 \ -2 \ -5]$,

```
q = polyder(p)
```

```
q =
     3     0    -2
```

`polyder` also computes the derivative of the product or quotient of two polynomials. For example, create two polynomials `a` and `b`.

```
a = [1 3 5];
b = [2 4 6];
```

Calculate the derivative of the product $a*b$ by calling `polyder` with a single output argument.

```
c = polyder(a,b)

c =
     8     30     56     38
```

Calculate the derivative of the quotient a/b by calling `polyder` with two output arguments.

```
[q,d] = polyder(a,b)

q =
    -2    -8    -2

d =
     4     16     40     48     36
```

q/d is the result of the operation.

Polynomial Curve Fitting

`polyfit` finds the coefficients of a polynomial that fits a set of data in a least-squares sense.

```
p = polyfit(x,y,n)
```

x and y are vectors containing the x and y data to be fitted, and n is the order of the polynomial to return. For example, consider the x - y test data.

```
x = [1 2 3 4 5]; y = [5.5 43.1 128 290.7 498.4];
```

A third order polynomial that approximately fits the data is

```
p = polyfit(x,y,3)

p =
   -0.1917   31.5821  -60.3262   35.3400
```

Compute the values of the `polyfit` estimate over a finer range, and plot the estimate over the real data values for comparison.

```
x2 = 1:.1:5;
y2 = polyval(p,x2);
plot(x,y,'o',x2,y2)
grid on
```

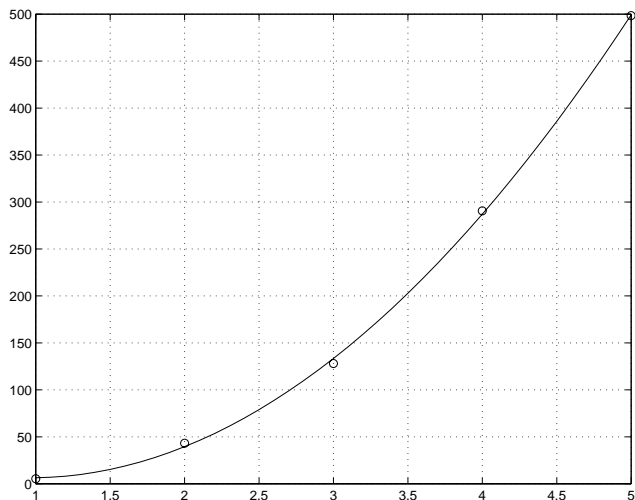

To use these functions in an application example, see the “Data Analysis and Statistics” chapter.

Partial Fraction Expansion

residue finds the partial fraction expansion of the ratio of two polynomials. This is particularly useful for applications that represent systems in transfer function form. For polynomials b and a , if there are no multiple roots,

$$\frac{b(s)}{a(s)} = \frac{r_1}{s-p_1} + \frac{r_2}{s-p_2} + \dots + \frac{r_n}{s-p_n} + k_s$$

where r is a column vector of residues, p is a column vector of pole locations, and k is a row vector of direct terms. Consider the transfer function

$$\frac{-4s + 8}{s^2 + 6s + 8}$$

```
b = [-4 8];  
a = [1 6 8];  
[r,p,k] = residue(b,a)
```

```
r =  
    -12  
     8
```

```
p =  
    -4  
    -2
```

```
k =  
    []
```

Given three input arguments (r, p, and k), residue converts back to polynomial form.

```
[b2,a2] = residue(r,p,k)
```

```
b2 =  
    -4     8
```

```
a2 =  
     1     6     8
```

Interpolation

Interpolation is a process for estimating values that lie between known data points. It has important applications in areas such as signal and image processing.

This section:

- Provides a summary of the MATLAB interpolation functions
- Discusses one-dimensional interpolation
- Discusses two-dimensional interpolation
- Uses an example to compare nearest neighbor, bilinear, and bicubic interpolation methods
- Discusses interpolation of multidimensional data
- Discusses triangulation and interpolation of scattered data

Interpolation Function Summary

MATLAB provides a number of interpolation techniques that let you balance the smoothness of the data fit with speed of execution and memory usage.

The interpolation functions reside in the MATLAB `polyfun` directory.

Interpolation Function Summary

Function	Description
<code>griddata</code>	Data gridding and surface fitting.
<code>griddata3</code>	Data gridding and hypersurface fitting for three-dimensional data.
<code>griddatan</code>	Data gridding and hypersurface fitting (dimension ≥ 3).
<code>interp1</code>	One-dimensional interpolation (table lookup).
<code>interp2</code>	Two-dimensional interpolation (table lookup).
<code>interp3</code>	Three-dimensional interpolation (table lookup).
<code>interpft</code>	One-dimensional interpolation using FFT method.

Interpolation Function Summary (Continued)

Function	Description
<code>interp</code>	N-D interpolation (table lookup).
<code>mkpp</code>	Make a piecewise polynomial
<code>pchip</code>	Piecewise Cubic Hermite Interpolating Polynomial (PCHIP).
<code>ppval</code>	Piecewise polynomial evaluation
<code>spline</code>	Cubic spline data interpolation
<code>unmkpp</code>	Piecewise polynomial details

One-Dimensional Interpolation

There are two kinds of one-dimensional interpolation in MATLAB:

- Polynomial interpolation
- FFT-based interpolation

Polynomial Interpolation

The function `interp1` performs one-dimensional interpolation, an important operation for data analysis and curve fitting. This function uses polynomial techniques, fitting the supplied data with polynomial functions between data points and evaluating the appropriate function at the desired interpolation points. Its most general form is

$$y_i = \text{interp1}(x, y, x_i, \text{method})$$

y is a vector containing the values of a function, and x is a vector of the same length containing the points for which the values in y are given. x_i is a vector containing the points at which to interpolate. *method* is an optional string specifying an interpolation method:

- *Nearest neighbor interpolation* (`method = 'nearest'`). This method sets the value of an interpolated point to the value of the nearest existing data point.
- *Linear interpolation* (`method = 'linear'`). This method fits a different linear function between each pair of existing data points, and returns the value of

the relevant function at the points specified by x_i . This is the default method for the `interp1` function.

- *Cubic spline interpolation* (method = 'spline'). This method fits a different cubic function between each pair of existing data points, and uses the spline function to perform cubic spline interpolation at the data points.
- *Cubic interpolation* (method = 'pchip' or 'cubic'). These methods are identical. They use the `pchip` function to perform piecewise cubic Hermite interpolation within the vectors x and y . These methods preserve monotonicity and the shape of the data.

If any element of x_i is outside the interval spanned by x , the specified interpolation method is used for extrapolation. Alternatively, `yi = interp1(x,Y,xi,method,extrapval)` replaces extrapolated values with `extrapval`. `NaN` is often used for `extrapval`.

All methods work with nonuniformly spaced data.

Speed, Memory, and Smoothness Considerations

When choosing an interpolation method, keep in mind that some require more memory or longer computation time than others. However, you may need to trade off these resources to achieve the desired smoothness in the result.

- Nearest neighbor interpolation is the fastest method. However, it provides the worst results in terms of smoothness.
- Linear interpolation uses more memory than the nearest neighbor method, and requires slightly more execution time. Unlike nearest neighbor interpolation its results are continuous, but the slope changes at the vertex points.
- Cubic spline interpolation has the longest relative execution time, although it requires less memory than cubic interpolation. It produces the smoothest results of all the interpolation methods. You may obtain unexpected results, however, if your input data is non-uniform and some points are much closer together than others.
- Cubic interpolation requires more memory and execution time than either the nearest neighbor or linear methods. However, both the interpolated data and its derivative are continuous.

The relative performance of each method holds true even for interpolation of two-dimensional or multidimensional data. For a graphical comparison of

interpolation methods, see the section “Comparing Interpolation Methods” on page 12-14.

FFT-Based Interpolation

The function `interpft` performs one-dimensional interpolation using an FFT-based method. This method calculates the Fourier transform of a vector that contains the values of a periodic function. It then calculates the inverse Fourier transform using more points. Its form is

```
y = interpft(x,n)
```

`x` is a vector containing the values of a periodic function, sampled at equally spaced points. `n` is the number of equally spaced points to return.

Two-Dimensional Interpolation

The function `interp2` performs two-dimensional interpolation, an important operation for image processing and data visualization. Its most general form is

```
ZI = interp2(X,Y,Z,XI,YI,method)
```

`Z` is a rectangular array containing the values of a two-dimensional function, and `X` and `Y` are arrays of the same size containing the points for which the values in `Z` are given. `XI` and `YI` are matrices containing the points at which to interpolate the data. `method` is an optional string specifying an interpolation method.

There are three different interpolation methods for two-dimensional data:

- *Nearest neighbor interpolation* (`method = 'nearest'`). This method fits a piecewise constant surface through the data values. The value of an interpolated point is the value of the nearest point.
- *Bilinear interpolation* (`method = 'linear'`). This method fits a bilinear surface through existing data points. The value of an interpolated point is a combination of the values of the four closest points. This method is piecewise bilinear, and is faster and less memory-intensive than bicubic interpolation.
- *Bicubic interpolation* (`method = 'cubic'`). This method fits a bicubic surface through existing data points. The value of an interpolated point is a combination of the values of the sixteen closest points. This method is piecewise bicubic, and produces a much smoother surface than bilinear interpolation. This can be a key advantage for applications like image

processing. Use bicubic interpolation when the interpolated data and its derivative must be continuous.

All of these methods require that X and Y be monotonic, that is, either always increasing or always decreasing from point to point. You should prepare these matrices using the `meshgrid` function, or else be sure that the “pattern” of the points emulates the output of `meshgrid`. In addition, each method automatically maps the input to an equally spaced domain before interpolating. If X and Y are already equally spaced, you can speed execution time by prepending an asterisk to the method string, for example, `'*cubic'`.

Comparing Interpolation Methods

This example compares two-dimensional interpolation methods on a 7-by-7 matrix of data.

1 Generate the peaks function at low resolution.

```
[x,y] = meshgrid(-3:1:3);  
z = peaks(x,y);  
surf(x,y,z)
```

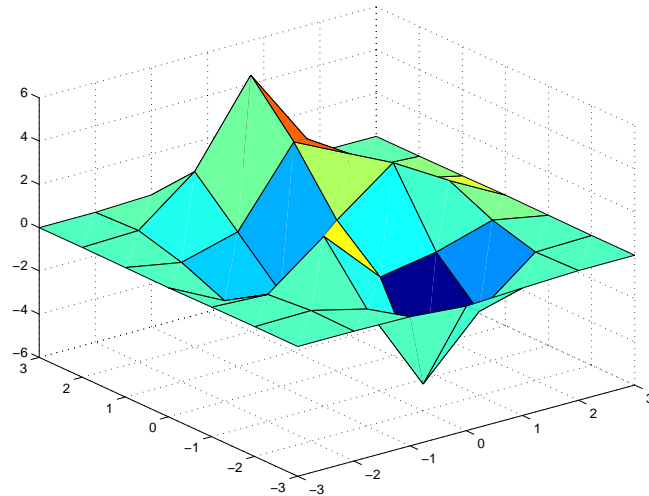

2 Generate a finer mesh for interpolation.

```
[xi,yi] = meshgrid(-3:0.25:3);
```

3 Interpolate using nearest neighbor interpolation.

```
zi1 = interp2(x,y,z,xi,yi,'nearest');
```

4 Interpolate using bilinear interpolation:

```
zi2 = interp2(x,y,z,xi,yi,'bilinear');
```

5 Interpolate using bicubic interpolation.

```
zi3 = interp2(x,y,z,xi,yi,'bicubic');
```

6 Compare the surface plots for the different interpolation methods.

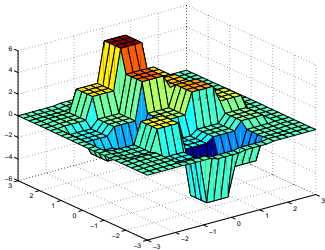

```
surf(xi,yi,zi1)  
% nearest
```

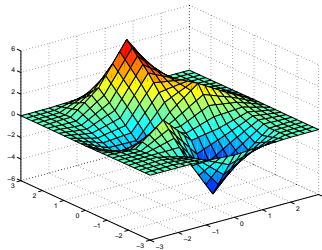

```
surf(xi,yi,zi2)  
% bilinear
```

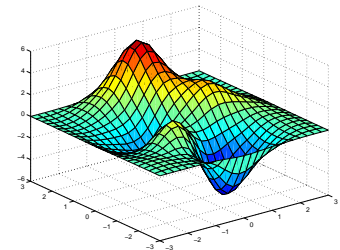

```
surf(xi,yi,zi3)  
% bicubic
```

7 Compare the contour plots for the different interpolation methods.

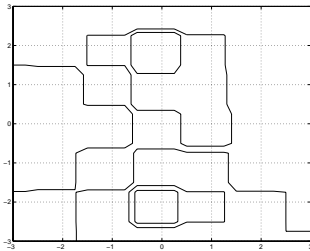

contour(xi,yi,zi1)
% nearest

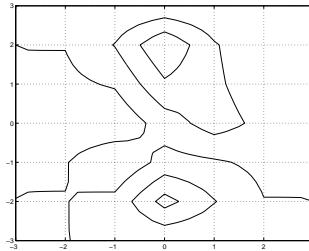

contour(xi,yi,zi2)
% bilinear

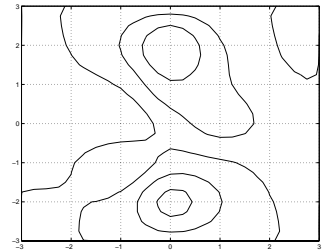

contour(xi,yi,zi3)
% bicubic

Notice that the bicubic method, in particular, produces smoother contours. This is not always the primary concern, however. For some applications, such as medical image processing, a method like nearest neighbor may be preferred because it doesn't generate any "new" data values.

Interpolation and Multidimensional Arrays

Several interpolation functions operate specifically on multidimensional data.

Interpolation Functions for Multidimensional Data

Function	Description
interp3	Three-dimensional data interpolation.
interpn	Multidimensional data interpolation.
ndgrid	Multidimensional data gridding (ndfun directory).

This section discusses:

- Interpolation of three-dimensional data
- Interpolation of higher dimensional data
- Multidimensional data gridding

Interpolation of Three-Dimensional Data

The function `interp3` performs three-dimensional interpolation, finding interpolated values between points of a three-dimensional set of samples V . You must specify a set of known data points:

- X , Y , and Z matrices specify the points for which values of V are given.
- A matrix V contains values corresponding to the points in X , Y , and Z .

The most general form for `interp3` is

```
VI = interp3(X,Y,Z,V,XI,YI,ZI,method)
```

XI , YI , and ZI are the points at which `interp3` interpolates values of V . For out-of-range values, `interp3` returns NaN.

There are three different interpolation methods for three-dimensional data:

- *Nearest neighbor interpolation* (`method = 'nearest'`). This method chooses the value of the nearest point.
- *Trilinear interpolation* (`method = 'linear'`). This method uses piecewise linear interpolation based on the values of the nearest eight points.
- *Tricubic interpolation* (`method = 'cubic'`). This method uses piecewise cubic interpolation based on the values of the nearest sixty-four points.

All of these methods require that X , Y , and Z be *monotonic*, that is, either always increasing or always decreasing in a particular direction. In addition, you should prepare these matrices using the `meshgrid` function, or else be sure that the “pattern” of the points emulates the output of `meshgrid`.

Each method automatically maps the input to an equally spaced domain before interpolating. If x is already equally spaced, you can speed execution time by prepending an asterisk to the `method` string, for example, `'*cubic'`.

Interpolation of Higher Dimensional Data

The function `interp n` performs multidimensional interpolation, finding interpolated values between points of a multidimensional set of samples V . The most general form for `interp n` is

```
VI = interp $n$ (X1,X2,X3...,V,Y1,Y2,Y3...,method)
```

1, 2, 3, ... are matrices that specify the points for which values of V are given. V is a matrix that contains the values corresponding to these points. 1, 2, 3, ...

are the points for which `interp` returns interpolated values of V . For out-of-range values, `interp` returns NaN.

Y_1, Y_2, Y_3, \dots must be either arrays of the same size, or vectors. If they are vectors of different sizes, `interp` passes them to `ndgrid` and then uses the resulting arrays.

There are three different interpolation methods for multidimensional data:

- *Nearest neighbor interpolation* (`method = 'nearest'`). This method chooses the value of the nearest point.
- *Linear interpolation* (`method = 'linear'`). This method uses piecewise linear interpolation based on the values of the nearest two points in each dimension.
- *Cubic interpolation* (`method = 'cubic'`). This method uses piecewise cubic interpolation based on the values of the nearest four points in each dimension.

All of these methods require that X_1, X_2, X_3 be monotonic. In addition, you should prepare these matrices using the `ndgrid` function, or else be sure that the “pattern” of the points emulates the output of `ndgrid`.

Each method automatically maps the input to an equally spaced domain before interpolating. If X is already equally spaced, you can speed execution time by prepending an asterisk to the method string; for example, `'*cubic'`.

Multidimensional Data Gridding

The `ndgrid` function generates arrays of data for multidimensional function evaluation and interpolation. `ndgrid` transforms the domain specified by a series of input vectors into a series of output arrays. The i th dimension of these output arrays are copies of the elements of input vector x_i .

The syntax for `ndgrid` is

$$[X_1, X_2, X_3, \dots] = \text{ndgrid}(x_1, x_2, x_3, \dots)$$

For example, assume that you want to evaluate a function of three variables over a given range. Consider the function

$$z = x_2 e^{(-x_1^2 - x_2^2 - x_3^2)}$$

for $-2\pi \leq x_1 \leq 0$, $2\pi \leq x_2 \leq 4\pi$, and $0 \leq x_3 \leq 2\pi$. To evaluate and plot this function:

```
x1 = -2:0.2:2;
x2 = -2:0.25:2;
x3 = -2:0.16:2;
[X1,X2,X3] = ndgrid(x1,x2,x3);
z = X2.*exp(-X1.^2 -X2.^2 -X3.^2);
slice(X2,X1,X3,z,[-1.2.8 2],2,[-2 0.2])
```

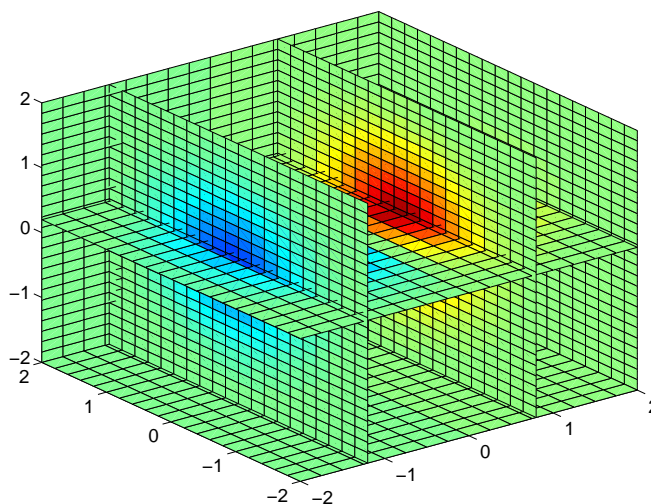

Triangulation and Interpolation of Scattered Data

MATLAB provides routines that aid in the analysis of closest-point problems and geometric analysis.

Functions for Analysis of Closest-Point Problems and Geometric Analysis

Function	Description
convhull	Convex hull.
delaunay	Delaunay triangulation.

Functions for Analysis of Closest-Point Problems and Geometric Analysis

Function	Description
delaunay3	3-D Delaunay tessellation.
dsearch	Nearest point search of Delaunay triangulation.
inpolygon	True for points inside polygonal region.
polyarea	Area of polygon.
rectint	Area of intersection for two or more rectangles.
tsearch	Closest triangle search.
voronoi	Voronoi diagram.

This section applies the following techniques to the seamount data set supplied with MATLAB:

- Convex hulls
- Delaunay triangulation
- Voronoi diagrams

See also “Tessellation and Interpolation of Scattered Data in Higher Dimensions” on page 12-27.

Note Examples in this section use the MATLAB seamount data set. Seamounts are underwater mountains. They are valuable sources of information about marine geology. The seamount data set represents the surface, in 1984, of the seamount designated LR148.8W located at 48.2°S, 148.8°W on the Louisville Ridge in the South Pacific. For more information about the data and its use, see Parker [2].

The seamount data set provides longitude (x), latitude (y) and depth-in-feet (z) data for 294 points on the seamount LR148.8W.

Convex Hulls

The `convhull` function returns the indices of the points in a data set that comprise the convex hull for the set. Use the `plot` function to plot the output of `convhull`.

This example loads the seamount data and plots the longitudinal (x) and latitudinal (y) data as a scatter plot. It then generates the convex hull and uses `plot` to plot the convex hull.

```
load seamount
plot(x,y, '.', 'markersize',10)
k = convhull(x,y);
hold on, plot(x(k),y(k), '-r'), hold off
grid on
```

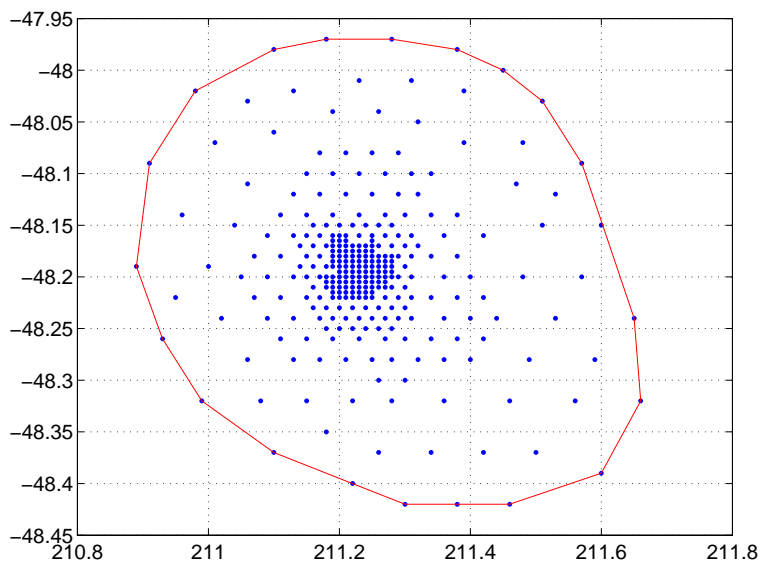

Delaunay Triangulation

Given a set of coplanar data points, *Delaunay triangulation* is a set of lines connecting each point to its natural neighbors. The `delaunay` function returns a Delaunay triangulation as a set of triangles such that no data points are contained in any triangle's circumcircle.

You can use `triplot` to print the resulting triangles in two-dimensional space. You can also add data for a third dimension to the output of `delaunay` and plot the result as a surface with `trisurf`, or as a mesh with `trimesh`.

Plotting a Delaunay Triangulation. To try `delaunay`, load the seamount data set and view the longitude (x) and latitude (y) data as a scatter plot.

```
load seamount
plot(x,y,'.','markersize',12)
xlabel('Longitude'), ylabel('Latitude')
grid on
```

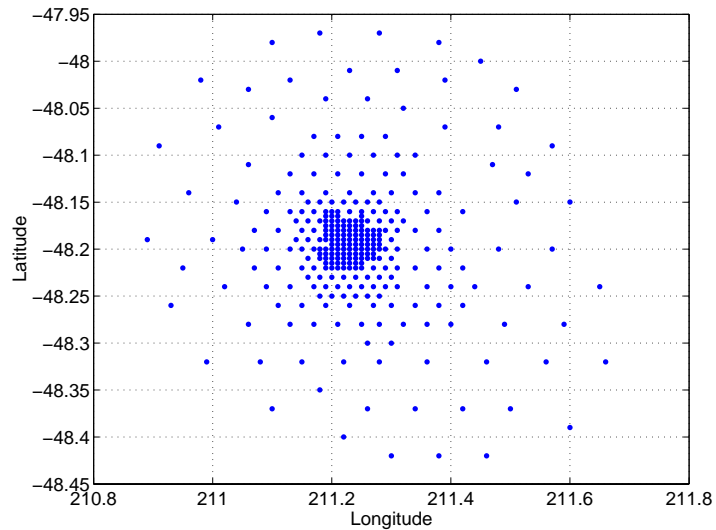

Apply Delaunay triangulation and use `triplot` to overplot the resulting triangles on the scatter plot.

```
tri = delaunay(x,y);
hold on, triplot(tri,x,y), hold off
```

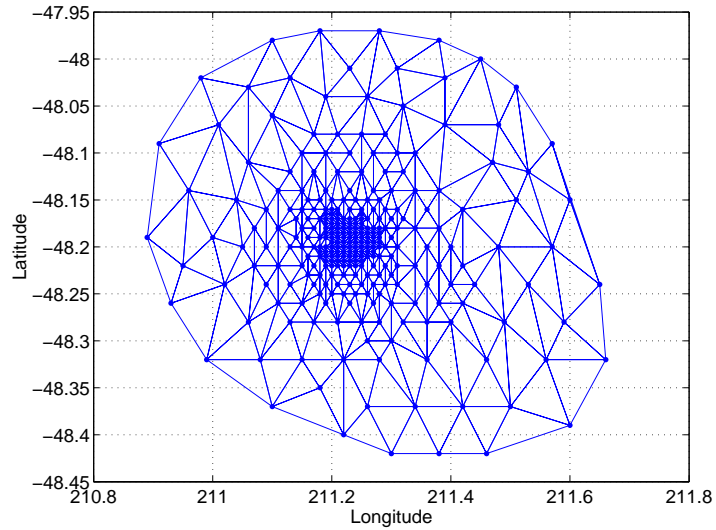
Mesh and Surface Plots. Add the depth data (z) from seamount, to the Delaunay triangulation, and use `trimesh` to produce a mesh in three-dimensional space. Similarly, you can use `trisurf` to produce a surface.

```
figure
hidden on
trimesh(tri,x,y,z)
grid on
xlabel('Longitude'); ylabel('Latitude'); zlabel('Depth in Feet')
```

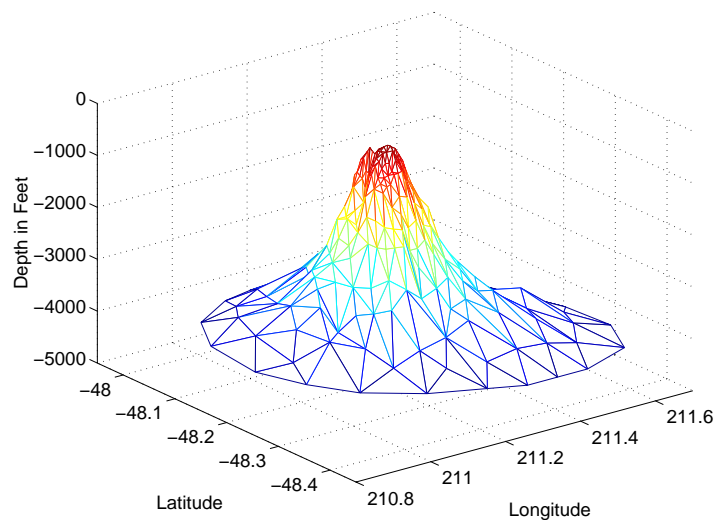

Contour Plots. This code uses `meshgrid`, `griddata`, and `contour` to produce a contour plot of the seamount data.

```
figure
[xi,yi] = meshgrid(210.8:.01:211.8,-48.5:.01:-47.9);
zi = griddata(x,y,z,xi,yi,'cubic');
[c,h] = contour(xi,yi,zi,'b-');
clabel(c,h)
xlabel('Longitude'), ylabel('Latitude')
```

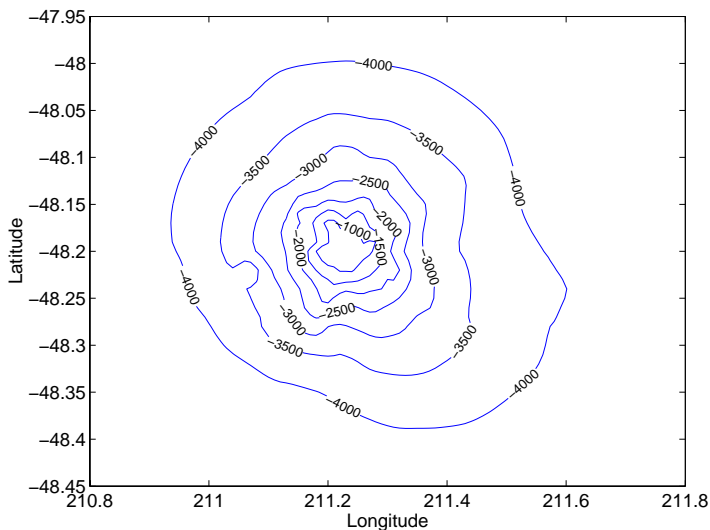

The arguments for `meshgrid` encompass the largest and smallest x and y values in the original seamount data. To obtain these values, use `min(x)`, `max(x)`, `min(y)`, and `max(y)`.

Closest-Point Searches. You can search through the Delaunay triangulation data with two functions:

- `dsearch` finds the indices of the (x,y) points in a Delaunay triangulation closest to the points you specify. This code searches for the point closest to $(211.32, -48.35)$ in the triangulation of the seamount data.

```
xi = 211.32; yi = -48.35;
p = dsearch(x,y,tri,xi,yi);
[x(p), y(p)]
```

```
ans =
    211.3400  -48.3700
```

- `tsearch`, finds the indices into the `delaunay` output that specify the enclosing triangles of the points you specify. This example uses the index of the enclosing triangle for the point $(211.32, -48.35)$ to obtain the coordinates of the vertices of the triangle.

```
xi = 211.32; yi = -48.35;  
t = tsearch(x,y,tri,xi,yi);  
r = tri(t,:);  
A = [x(r) y(r)]
```

```
A =  
211.3000 -48.3000  
211.3400 -48.3700  
211.2800 -48.3200
```

Voronoi Diagrams

Voronoi diagrams are a closest-point plotting technique related to Delaunay triangulation.

For each point in a set of coplanar points, you can draw a polygon that encloses all the intermediate points that are closer to that point than to any other point in the set. Such a polygon is called a *Voronoi polygon*, and the set of all Voronoi polygons for a given point set is called a *Voronoi diagram*.

The `voronoi` function can plot the cells of the Voronoi diagram, or return the vertices of the edges of the diagram. This example loads the `seamount` data, then uses the `voronoi` function to produce the Voronoi diagram for the longitudinal (x) and latitudinal (y) dimensions. Note that `voronoi` plots only the bounded cells of the Voronoi diagram.

```
load seamount  
voronoi(x,y)  
grid on  
xlabel('Longitude'), ylabel('Latitude')
```

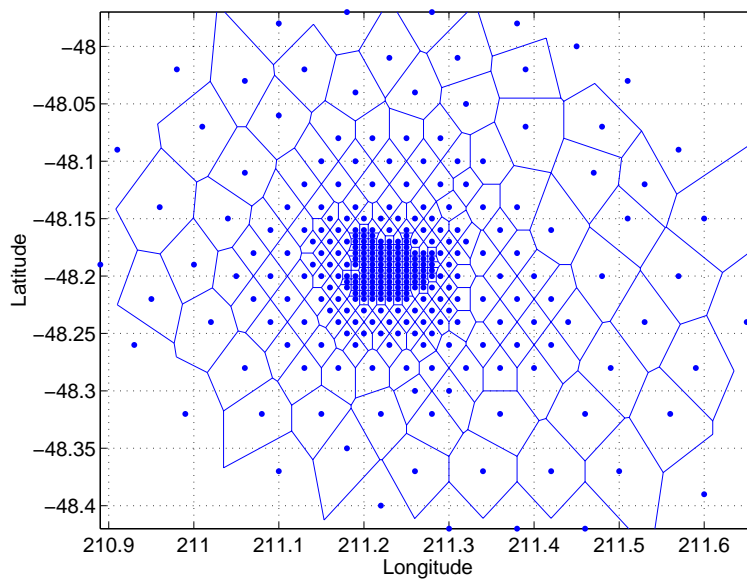

Note See the `voronoi` function for an example that uses the vertices of the edges to plot a Voronoi diagram.

Tessellation and Interpolation of Scattered Data in Higher Dimensions

Many applications in science, engineering, statistics, and mathematics require structures like convex hulls, Voronoi diagrams, and Delaunay tessellations.

Using Qhull [1], MATLAB functions enable you to geometrically analyze data sets in any dimension.

Functions for Multidimensional Geometrical Analysis

Function	Description
convhulln	n-D convex hull.
delaunayn	n-D Delaunay tessellation.
dsearchn	n-D nearest point search.
griddatan	n-D data gridding and hypersurface fitting.
tsearchn	n-D closest simplex search.
voronoin	n-D Voronoi diagrams.

This section demonstrates these geometric analysis techniques:

- Convex hulls
- Delaunay triangulations
- Voronoi diagrams
- Interpolation of scattered multidimensional data

Convex Hulls

The convex hull of a data set in n-dimensional space is defined as the smallest convex region that contains the data set.

Computing a Convex Hull. The `convhulln` function returns the indices of the points in a data set that comprise the facets of the convex hull for the set. For example, suppose X is an 8-by-3 matrix that consists of the 8 vertices of a cube. The convex hull of X then consists of 12 facets.

```
d = [-1 1];
[x,y,z] = meshgrid(d,d,d);
X = [x(:),y(:),z(:)];      % 8 corner points of a cube
C = convhulln(X)

C =
```

```

3     1     5
1     2     5
2     1     3
7     3     5
8     7     5
7     8     3
6     8     5
2     6     5
6     2     8
8     4     3
4     2     3
2     4     8

```

Because the data is three-dimensional, the facets that make up the convex hull are triangles. The 12 rows of `C` represent 12 triangles. The elements of `C` are indices of points in `X`. For example, the first row, 3 1 5, means that the first triangle has `X(3, :)`, `X(1, :)`, and `X(5, :)` as its vertices.

For three-dimensional convex hulls, you can use `trisurf` to plot the output. However, using `patch` to plot the output gives you more control over the color of the facets. Note that you cannot plot `convhulln` output for $n > 3$.

This code plots the convex hull by drawing the triangles as three-dimensional patches.

```

figure, hold on
d = [1 2 3 1      % Index into C column.
for i = 1:size(C,1) % Draw each triangle.
    j= C(i,d);      % Get the ith C to make a patch.
    h(i)=patch(X(j,1),X(j,2),X(j,3),i,'FaceAlpha',0.9);
end                % 'FaceAlpha' is used to make it transparent.
hold off
view(3), axis equal, axis off
camorbit(90,-5);   % To view it from another angle
title('Convex hull of a cube')

```

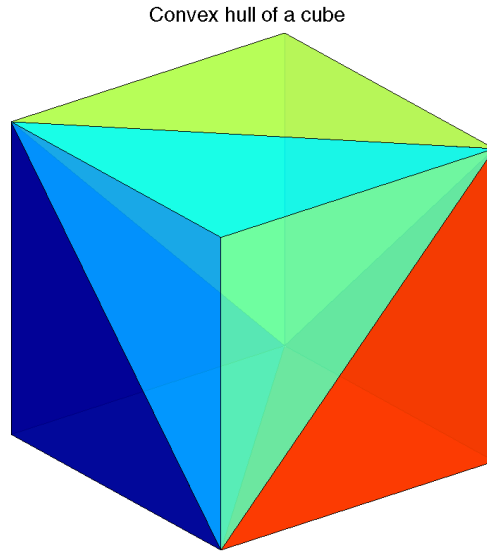

Delaunay Tessellations

A Delaunay tessellation is a set of simplices such that no data points are contained in any simplex's circumsphere. In two-dimensional space, a simplex is a triangle. In three-dimensional space, a simplex is a tetrahedron.

Computing a Delaunay Tessellation. The `delaunayn` function returns the indices of the points in a data set that comprise the simplices of an n -dimensional Delaunay tessellation of the data set.

This example uses the same X as in the convex hull example, i.e. the 8 corner points of a cube, with the addition of a center point.

```
d = [-1 1];  
[x,y,z] = meshgrid(d,d,d);  
X = [x(:),y(:),z(:)]; % 8 corner points of a cube  
X(9,:) = [0 0 0]; % Add center to the vertex list.  
T = delaunayn(X) % Generate Delaunay tessellation.
```



```
T =
     9     1     5     6
     3     9     1     5
     2     9     1     6
     2     3     9     4
     2     3     9     1
     7     9     5     6
     7     3     9     5
     8     7     9     6
     8     2     9     6
     8     2     9     4
     8     3     9     4
     8     7     3     9
```

The 12 rows of T represent the 12 simplices, in this case irregular tetrahedrons, that partition the cube. Each row represents one tetrahedron, and the row elements are indices of points in X .

For three-dimensional tessellations, you can use `tetramesh` to plot the output. However, using `patch` to plot the output gives you more control over the color of the facets. Note that you cannot plot `delaunayn` output for $n > 3$.

This code plots the tessellation T by drawing the tetrahedrons using three-dimensional patches.

```
figure, hold on
d = [1 1 1 2; 2 2 3 3; 3 4 4 4]; % Index into T
for i = 1:size(T,1) % Draw each tetrahedron.
    y = T(i,d); % Get the ith T to make a patch.
    x1 = reshape(X(y,1),3,4);
    x2 = reshape(X(y,2),3,4);
    x3 = reshape(X(y,3),3,4);
    h(i)=patch(x1,x2,x3,(1:4)*i, 'FaceAlpha',0.9);
end
hold off
view(3), axis equal
axis off
camorbit(65,120) % To view it from another angle
title('Delaunay tessellation of a cube with a center point')
```

You can use `cameramenue` to rotate the figure in any direction.

Delaunay tessellation of a cube with a center point

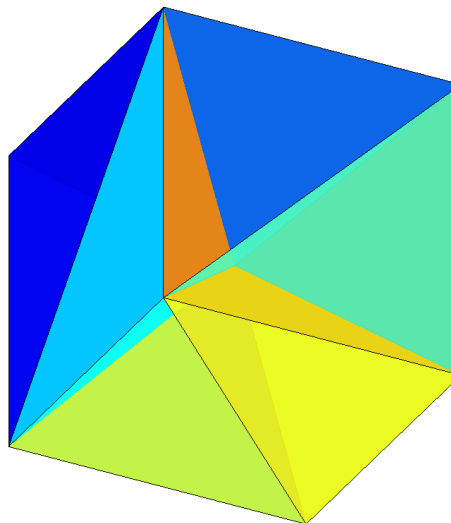

Voronoi Diagrams

Given m data points in n -dimensional space, a *Voronoi diagram* is the partition of n -dimensional space into m polyhedral regions, one region for each data point. Such a region is called a *Voronoi cell*. A Voronoi cell satisfies the condition that it contains all points that are closer to its data point than any other data point in the set.

Computing a Voronoi Diagram. The `voronoin` function returns two outputs:

- V is an m -by- n matrix of m points in n -space. Each row of V represents a Voronoi vertex.
- C is a cell array of vectors. Each vector in the cell array C represents a Voronoi cell. The vector contains indices of the points in V that are the vertices of the Voronoi cell. Each Voronoi cell may have a different number of points.

Because a Voronoi cell can be unbounded, the first row of V is a point at infinity. Then any unbounded Voronoi cell in C includes the point at infinity, i.e., the first point in V .

This example uses the same X as in the Delaunay example, i.e., the 8 corner points of a cube and its center. Random noise is added to make the cube less regular. The resulting Voronoi diagram has 9 Voronoi cells.

```
d = [-1 1];
[x,y,z] = meshgrid(d,d,d);
X = [x(:),y(:),z(:)]; % 8 corner points of a cube
X(9,:) = [0 0 0]; % Add center to the vertex list.
X = X+0.01*rand(size(X)); % Make the cube less regular.
[V,C] = voronoin(X);
```

```
V =
      Inf      Inf      Inf
    0.0055    1.5054    0.0004
    0.0037    0.0101   -1.4990
    0.0052    0.0087   -1.4990
    0.0030    1.5054    0.0030
    0.0072    0.0072    1.4971
   -1.7912    0.0000    0.0044
   -1.4886    0.0011    0.0036
   -1.4886    0.0002    0.0045
    0.0101    0.0044    1.4971
    1.5115    0.0074    0.0033
    1.5115    0.0081    0.0040
    0.0104   -1.4846   -0.0007
    0.0026   -1.4846    0.0071
```

```
C =
 [1x8 double]
 [1x6 double]
 [1x4 double]
 [1x6 double]
 [1x6 double]
 [1x6 double]
 [1x6 double]
 [1x6 double]
 [1x6 double]
 [1x12 double]
```

In this example, V is a 13-by-3 matrix, the 13 rows are the coordinates of the 13 Voronoi vertices. The first row of V is a point at infinity. C is a 9-by-1 cell array,

where each cell in the array contains an index vector into V corresponding to one of the 9 Voronoi cells. For example, the 9th cell of the Voronoi diagram is

$$C\{9\} = 2 \ 3 \ 4 \ 5 \ 6 \ 7 \ 8 \ 9 \ 10 \ 11 \ 12 \ 13$$

If any index in a cell of the cell array is 1, then the corresponding Voronoi cell contains the first point in V , a point at infinity. This means the Voronoi cell is unbounded.

To view a *bounded* Voronoi cell, i.e., one that does not contain a point at infinity, use the `convhulln` function to compute the vertices of the facets that make up the Voronoi cell. Then use `patch` and other plot functions to generate the figure. For example, this code plots the Voronoi cell defined by the 9th cell in C .

```
X = V(C{9},:);           % View 9th Voronoi cell.
K = convhulln(X);
figure
hold on
d = [1 2 3 1];          % Index into K
for i = 1:size(K,1)
    j = K(i,d);
    h(i)=patch(X(j,1),X(j,2),X(j,3),i,'FaceAlpha',0.9);
end
hold off
view(3)
axis equal
title('One cell of a Voronoi diagram')
```

One cell of a Voronoi diagram

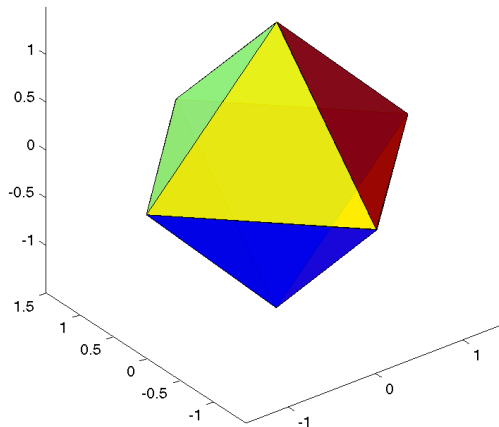

Interpolating N-Dimensional Data

Use the `griddatan` function to interpolate multidimensional data, particularly scattered data. `griddatan` uses the `delaunayn` function to tessellate the data, and then interpolates based on the tessellation.

Suppose you want to visualize a function that you have evaluated at a set of n scattered points. In this example, X is an n -by-3 matrix of points, each row containing the (x,y,z) coordinates for one of the points. The vector v contains the n function values at these points. The function for this example is the squared distance from the origin, $v = x.^2 + y.^2 + z.^2$.

Start by generating $n = 5000$ points at random in three-dimensional space, and computing the value of a function on those points.

```
n = 5000;  
X = 2*rand(n,3) - 1;  
v = sum(X.^2,2);
```

The next step is to use interpolation to compute function values over a grid. Use `meshgrid` to create the grid, and `griddatan` to do the interpolation.

```
delta = 0.05;
d = -1:delta:1;
[x0,y0,z0] = meshgrid(d,d,d);
X0 = [x0(:), y0(:), z0(:)];
v0 = griddatan(X,v,X0);
v0 = reshape(v0, size(x0));
```

Then use `isosurface` and related functions to visualize the surface that consists of the (x,y,z) values for which the function takes a constant value. You could pick any value, but the example uses the value 0.6. Since the function is the squared distance from the origin, the surface at a constant value is a sphere.

```
p = patch(isosurface(x0,y0,z0,v0,0.6));
isonormals(x0,y0,z0,v0,p);
set(p, 'FaceColor', 'red', 'EdgeColor', 'none');
view(3);
camlight;
lighting phong
axis equal
title('Interpolated sphere from scattered data')
```

Note A smaller `delta` produces a smoother sphere, but increases the compute time.

Interpolated sphere from scattered data

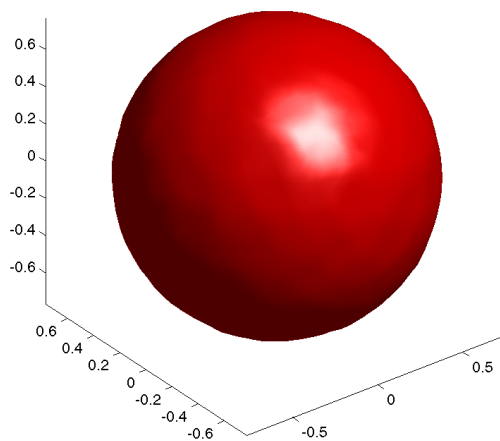

Selected Bibliography

[1] National Science and Technology Research Center for Computation and Visualization of Geometric Structures (The Geometry Center), University of Minnesota. 1993. For information about qhull, see <http://www.geom.umn.edu/software/qhull/>.

[2] Parker, Robert. L., Loren Shure, & John A. Hildebrand, "The Application of Inverse Theory to Seamount Magnetism." *Reviews of Geophysics*. Vol. 25, No. 1, 1987.

Data Analysis and Statistics

Column-Oriented Data Sets	13-4
Basic Data Analysis Functions	13-8
Function Summary	13-8
Covariance and Correlation Coefficients	13-11
Finite Differences	13-12
Data Preprocessing	13-14
Missing Values	13-14
Removing Outliers	13-15
Regression and Curve Fitting	13-17
Polynomial Regression	13-18
Linear-in-the-Parameters Regression	13-19
Multiple Regression	13-21
Case Study: Curve Fitting	13-22
Polynomial Fit	13-22
Analyzing Residuals	13-24
Exponential Fit	13-27
Error Bounds	13-30
The Basic Fitting Interface	13-31
Difference Equations and Filtering	13-40
Fourier Analysis and the Fast Fourier Transform (FFT)	13-43
Function Summary	13-43
Introduction	13-44
Magnitude and Phase of Transformed Data	13-49
FFT Length Versus Speed	13-50

This chapter introduces MATLAB's data analysis capabilities. It discusses how to organize arrays for data analysis, how to use simple descriptive statistics functions, and how to perform data preprocessing tasks in MATLAB. It also discusses other data analysis topics, including regression, curve fitting, data filtering, and fast Fourier transforms (FFTs). It includes:

Column-Oriented Data Sets

Organizing arrays for data analysis.

Basic Data Analysis Functions

Basic data analysis functions and an example that uses some of the functions. This section also discusses functions for the computation of correlation coefficients and covariance, and for finite difference calculations.

Data Preprocessing

Working with missing values, and outliers or misplaced data points in a data set.

Regression and Curve Fitting

Investigates the use of different regression methods to find functions that describe the relationship among observed variables.

Case Study: Curve Fitting

Uses a case study to look at some of MATLAB's basic data analysis capabilities. This section also provides information about the Basic Fitting interface.

Difference Equations and Filtering

Discusses MATLAB functions for working with difference equations and filters.

Fourier Analysis and the Fast Fourier Transform (FFT)

Discusses Fourier analysis in MATLAB

Data Analysis and Statistics Functions

The data analysis and statistics functions are in the directory `datafun` in the MATLAB Toolbox. Use online help to get a complete list of functions.

Related Toolboxes

A number of related toolboxes provide advanced functionality for specialized data analysis applications.

Toolbox	Data Analysis Application
Optimization	Nonlinear curve fitting and regression.
Signal Processing	Signal processing, filtering, and frequency analysis.
Spline	Curve fitting and regression.
Statistics	Advanced statistical analysis, nonlinear curve fitting, and regression.
System Identification	Parametric / ARMA modeling.
Wavelet	Wavelet analysis.

Column-Oriented Data Sets

Univariate statistical data is typically stored in individual vectors. The vectors can be either 1-by- n or n -by-1. For multivariate data, a matrix is the natural representation but there are, in principle, two possibilities for orientation. By MATLAB convention, however, the different variables are put into columns, allowing observations to vary down through the rows. Therefore, a data set consisting of twenty four samples of three variables is stored in a matrix of size 24-by-3.

Vehicle Traffic Sample Data Set

Consider a sample data set comprising vehicle traffic count observations at three locations over a 24-hour period.

Vehicle Traffic Sample Data Set

Time	Location 1	Location 2	Location 3
01h00	11	11	9
02h00	7	13	11
03h00	14	17	20
04h00	11	13	9
05h00	43	51	69
06h00	38	46	76
07h00	61	132	186
08h00	75	135	180
09h00	38	88	115
10h00	28	36	55
11h00	12	12	14
12h00	18	27	30
13h00	18	19	29

Vehicle Traffic Sample Data Set (Continued)

Time	Location 1	Location 2	Location 3
14h00	17	15	18
15h00	19	36	48
16h00	32	47	10
17h00	42	65	92
18h00	57	66	151
19h00	44	55	90
20h00	114	145	257
21h00	35	58	68
22h00	11	12	15
23h00	13	9	15
24h00	10	9	7

Loading and Plotting the Data

The raw data is stored in the file, count.dat.

```
11  11  9
 7  13  11
14  17  20
11  13  9
43  51  69
38  46  76
61 132 186
75 135 180
38  88 115
28  36  55
12  12  14
18  27  30
18  19  29
17  15  18
19  36  48
```

```
32  47  10
42  65  92
57  66 151
44  55  90
114 145 257
35  58  68
11  12  15
13  9   15
10  9   7
```

Use the `load` command to import the data.

```
load count.dat
```

This creates the matrix `count` in the workspace.

For this example, there are 24 observations of three variables. This is confirmed by

```
[n,p] = size(count)
n =
    24
p =
     3
```

Create a time vector, `t`, of integers from 1 to `n`.

```
t = 1:n;
```

Now plot the counts versus time and annotate the plot.

```
set(0,'defaultaxeslinestyleorder','-|--|-.')
set(0,'defaultaxescolororder',[0 0 0])
plot(t,count), legend('Location 1','Location 2','Location 3',2)
xlabel('Time'), ylabel('Vehicle Count'), grid on
```

The plot shows the vehicle counts at three locations over a 24-hour period.

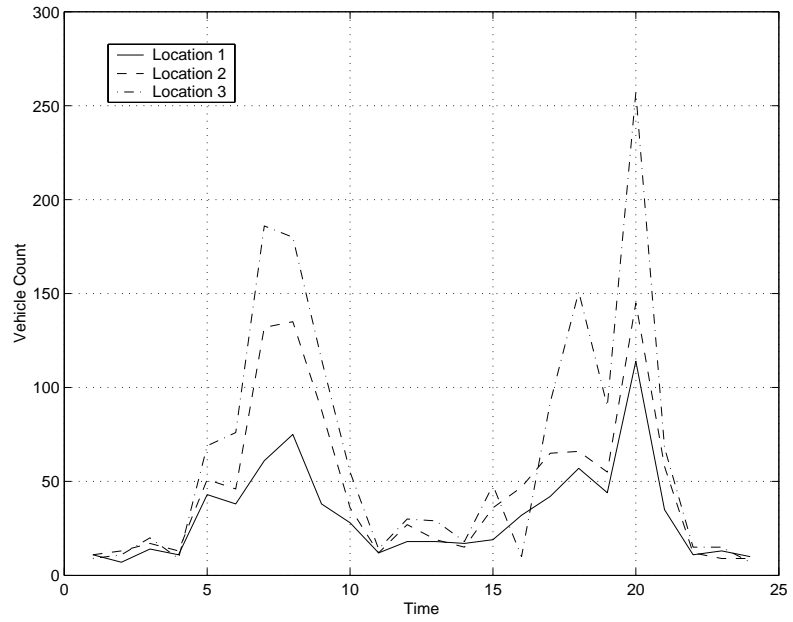

Basic Data Analysis Functions

This section introduces functions for:

- Basic column-oriented data analysis
- Computation of correlation coefficients and covariance
- Calculating finite differences

Function Summary

A collection of functions provides basic column-oriented data analysis capabilities. These functions are located in the MATLAB `datafun` directory.

This section also gives you some hints about using row and column data, and provides some basic examples. This table lists the functions.

Basic Data Analysis Function Summary

Function	Description
<code>cumprod</code>	Cumulative product of elements.
<code>cumsum</code>	Cumulative sum of elements.
<code>cumtrapz</code>	Cumulative trapezoidal numerical integration.
<code>diff</code>	Difference function and approximate derivative.
<code>max</code>	Largest component.
<code>mean</code>	Average or mean value.
<code>median</code>	Median value.
<code>min</code>	Smallest component.
<code>prod</code>	Product of elements.
<code>sort</code>	Sort in ascending order.
<code>sortrows</code>	Sort rows in ascending order.
<code>std</code>	Standard deviation.

Basic Data Analysis Function Summary (Continued)

Function	Description
sum	Sum of elements.
trapez	Trapezoidal numerical integration.

For information about calculating the maximum, minimum, mean, median, range, and standard deviation on plotted data, and creating plots of these statistics, see “Adding Plots of Data Statistics to a Graph” in the MATLAB graphics documentation.

Working with Row and Column Data

For vector input arguments to these functions, it does not matter whether the vectors are oriented in row or column direction. For array arguments, however, the functions operate column by column on the data in the array. This means, for example, that if you apply `max` to an array, the result is a row vector containing the maximum values over each column.

Note You can add more functions to this list using M-files, but when doing so, you must exercise care to handle the row-vector case. If you are writing your own column-oriented M-files, check other M-files; for example, `mean.m` and `diff.m`.

Basic Examples

Continuing with the vehicle traffic count example, the statements

```
mx = max(count)
mu = mean(count)
sigma = std(count)
```

result in

```
mx =
      114      145      257

mu =
  32.0000  46.5417  65.5833
```

```
sigma =  
    25.3703    41.4057    68.0281
```

To locate the index at which the minimum or maximum occurs, a second output parameter can be specified. For example,

```
[mx,indx] = min(count)  
  
mx =  
    7    9    7  
  
indx =  
    2   23   24
```

shows that the lowest vehicle count is recorded at 02h00 for the first observation point (column one) and at 23h00 and 24h00 for the other observation points.

You can subtract the mean from each column of the data using an outer product involving a vector of n ones.

```
[n,p] = size(count)  
e = ones(n,1)  
x = count - e*mu
```

Rearranging the data may help you evaluate a vector function over an entire data set. For example, to find the smallest value in the entire data set, use

```
min(count(:))
```

which produces

```
ans =  
    7
```

The syntax `count(:)` rearranges the 24-by-3 matrix into a 72-by-1 column vector.

Covariance and Correlation Coefficients

MATLAB's statistical capabilities include two functions for the computation of correlation coefficients and covariance.

Covariance and Correlation Coefficient Function Summary

Function	Description
cov	Variance of vector – measure of spread or dispersion of sample variable. Covariance of matrix – measure of strength of linear relationships between variables.
corrcoef	Correlation coefficient – normalized measure of linear relationship strength between variables.

Covariance

cov returns the variance for a vector of data. The variance of the data in the first column of count is

```
cov(count(:,1))
```

```
ans =  
643.6522
```

For an array of data, cov calculates the covariance matrix. The variance values for the array columns are arranged along the diagonal of the covariance matrix. The remaining entries reflect the covariance between the columns of the original array. For an m -by- n matrix, the covariance matrix has size n -by- n . For example, the covariance matrix for count, cov(count), is arranged as

$$\begin{bmatrix} \sigma_{11}^2 & \sigma_{12}^2 & \sigma_{13}^2 \\ \sigma_{21}^2 & \sigma_{22}^2 & \sigma_{23}^2 \\ \sigma_{31}^2 & \sigma_{32}^2 & \sigma_{33}^2 \end{bmatrix}$$

$$\sigma_{ij}^2 = \sigma_{ji}^2$$

Correlation Coefficients

`corrcoef` produces a matrix of correlation coefficients for an array of data where each row is an observation and each column is a variable. The *correlation coefficient* is a normalized measure of the strength of the linear relationship between two variables. Uncorrelated data results in a correlation coefficient of 0; equivalent data sets have a correlation coefficient of 1.

For an m -by- n matrix, the correlation coefficient matrix has size n -by- n . The arrangement of the elements in the correlation coefficient matrix corresponds to the location of the elements in the covariance matrix described above.

For our traffic count example

```
corrcoef(count)
```

results in

```
ans =  
    1.0000    0.9331    0.9599  
    0.9331    1.0000    0.9553  
    0.9599    0.9553    1.0000
```

Clearly there is a strong linear correlation between the three traffic counts observed at the three locations, as the results are close to 1.

Finite Differences

MATLAB provides three functions for finite difference calculations.

Function	Description
<code>diff</code>	Difference between successive elements of a vector. Numerical partial derivatives of a vector.
<code>gradient</code>	Numerical partial derivatives a matrix.
<code>del2</code>	Discrete Laplacian of a matrix.

The `diff` function computes the difference between successive elements in a numeric vector. That is, `diff(X)` is $[X(2)-X(1) \ X(3)-X(2) \dots \ X(n)-X(n-1)]$. So, for a vector A ,

```
A = [9 -2 3 0 1 5 4];
```

```
diff(A)
```

```
ans =
```

```
   -11     5    -3     1     4    -1
```

Besides computing the first difference, `diff` is useful for determining certain characteristics of vectors. For example, you can use `diff` to determine if a vector is monotonic (elements are always either increasing or decreasing), or if a vector has equally spaced elements. This table describes a few different ways to use `diff` with a vector `x`.

Test	Description
<code>diff(x)==0</code>	Tests for repeated elements.
<code>all(diff(x)>0)</code>	Tests for monotonicity.
<code>all(diff(diff(x))==0)</code>	Tests for equally spaced vector elements.

Data Preprocessing

This section tells you how to work with

- Missing values
- Outliers and misplaced data points

Missing Values

The special value, NaN, stands for Not-a-Number in MATLAB. IEEE floating-point arithmetic convention specifies NaN as the result of undefined expressions such as $0/0$.

The correct handling of missing data is a difficult problem and often varies in different situations. For data analysis purposes, it is often convenient to use NaNs to represent missing values or data that are *not available*.

MATLAB treats NaNs in a uniform and rigorous way. They propagate naturally through to the final result in any calculation. Any mathematical calculation involving NaNs produces NaNs in the results.

For example, consider a matrix containing the 3-by-3 magic square with its center element set to NaN.

```
a = magic(3); a(2,2) = NaN
```

```
a =  
    8     1     6  
    3   NaN     7  
    4     9     2
```

Compute a sum for each column in the matrix.

```
sum(a)  
  
ans =  
    15   NaN    15
```

Any mathematical calculation involving NaNs propagates NaNs through to the final result as appropriate.

You should remove NaNs from the data before performing statistical computations. Here are some ways to use `isnan` to remove NaNs from data.

Code	Description
<pre>i = find(~isnan(x)); x = x(i)</pre>	Find indices of elements in vector that are not NaNs, then keep only the non-NaN elements.
<pre>x = x(find(~isnan(x)))</pre>	Remove NaNs from vector.
<pre>x = x(~isnan(x));</pre>	Remove NaNs from vector (faster).
<pre>x(isnan(x)) = [];</pre>	Remove NaNs from vector.
<pre>X(any(isnan(X)', :) = [];</pre>	Remove any rows of matrix X containing NaNs.

Note You must use the special function `isnan` to find NaNs because, by IEEE arithmetic convention, the logical comparison, `NaN == NaN` always produces 0. You *cannot* use `x(x==NaN) = []` to remove NaNs from your data.

If you frequently need to remove NaNs, write a short M-file function.

```
function X = excise(X)
X(any(isnan(X)', :) = [];
```

Now, typing

```
X = excise(X);
```

accomplishes the same thing.

Removing Outliers

You can remove outliers or misplaced data points from a data set in much the same manner as NaNs. For the vehicle traffic count data, the mean and standard deviations of each column of the data are

```
mu = mean(count)
```

```
sigma = std(count)

mu =
    32.0000    46.5417    65.5833

sigma =
    25.3703    41.4057    68.0281
```

The number of rows with outliers greater than three standard deviations is obtained with

```
[n,p] = size(count)
outliers = abs(count - mu(ones(n, 1),:)) > 3*sigma(ones(n, 1),:);
nout = sum(outliers)
nout =
     1     0     0
```

There is one outlier in the first column. Remove this entire observation with

```
count(any(outliers'), :) = [];
```

Regression and Curve Fitting

It is often useful to find functions that describe the relationship between some variables you have observed. Identification of the coefficients of the function often leads to the formulation of an overdetermined system of simultaneous linear equations. You can find these coefficients efficiently by using the MATLAB backslash operator.

Suppose you measure a quantity y at several values of time t .

```
t = [0 .3 .8 1.1 1.6 2.3]';  
y = [0.5 0.82 1.14 1.25 1.35 1.40]';  
plot(t,y,'o'), grid on
```

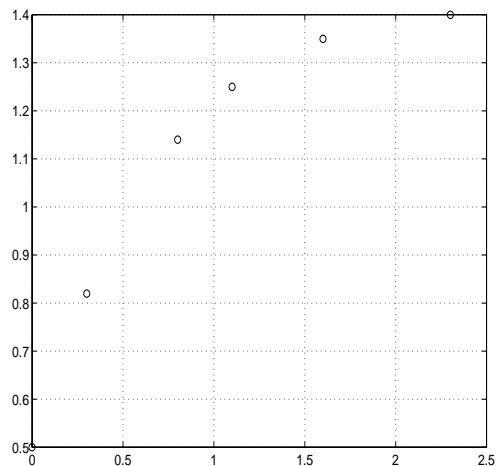

The following sections look at three ways of modeling the data:

- Polynomial regression
- Linear-in-the-parameters regression
- Multiple regression

The second-order polynomial model of the data is therefore

$$y = 0.5318 + 0.919(1)t - 0.2387t^2$$

Now evaluate the model at regularly spaced points and overlay the original data in a plot.

```
T = (0:0.1:2.5)';
Y = [ones(size(T)) T T.^2]*a;
plot(T,Y,'-',t,y,'o'), grid on
```

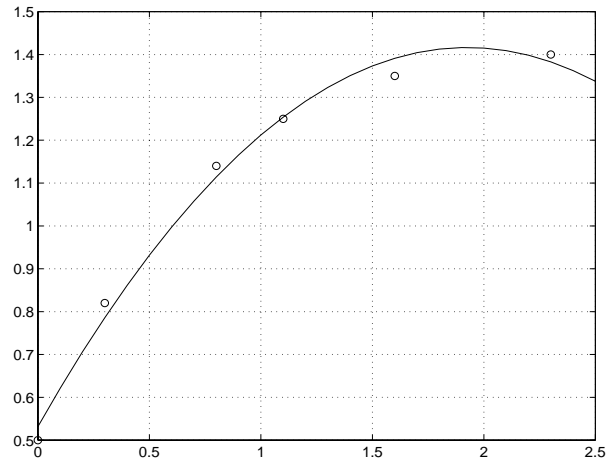

Clearly this fit does not perfectly approximate the data. We could either increase the order of the polynomial fit, or explore some other functional form to get a better approximation.

Linear-in-the-Parameters Regression

Instead of a polynomial function, we could try using a function that is linear-in-the-parameters. In this case, consider the exponential function

$$y = a_0 + a_1 e^{-t} + a_2 t e^{-t}$$

The unknown coefficients a_0 , a_1 , and a_2 , are computed by performing a *least squares fit*. Construct and solve the set of simultaneous equations by forming

the regression matrix, X , and solving for the coefficients using the backslash operator.

```
X = [ones(size(t)) exp(-t) t.*exp(-t)];
a = X\y
```

```
a =
    1.3974
   -0.8988
    0.4097
```

The fitted model of the data is, therefore,

$$y = 1.3974 - 0.8988 e^{-t} + 0.4097 t e^{-t}$$

Now evaluate the model at regularly spaced points and overlay the original data in a plot.

```
T = (0:0.1:2.5)';
Y = [ones(size(T)) exp(-T) T.*exp(-T)]*a;
plot(T,Y,'-',t,y,'o'), grid on
```

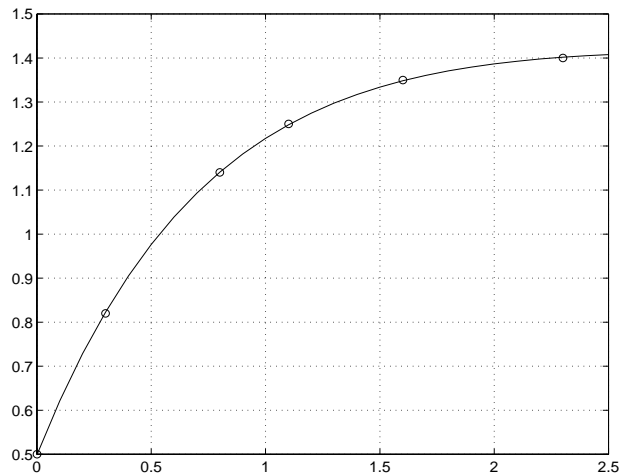

This is a much better fit than the second-order polynomial function.

Multiple Regression

If y is a function of more than one independent variable, the matrix equations that express the relationships among the variables can be expanded to accommodate the additional data.

Suppose we measure a quantity y for several values of parameters x_1 and x_2 . The observations are entered as

$$\begin{aligned}x_1 &= [.2 \ .5 \ .6 \ .8 \ 1.0 \ 1.1]'; \\x_2 &= [.1 \ .3 \ .4 \ .9 \ 1.1 \ 1.4]'; \\y &= [.17 \ .26 \ .28 \ .23 \ .27 \ .24]';\end{aligned}$$

A multivariate model of the data is

$$y = a_0 + a_1x_1 + a_2x_2$$

Multiple regression solves for unknown coefficients a_0 , a_1 , and a_2 , by performing a *least squares fit*. Construct and solve the set of simultaneous equations by forming the regression matrix, X , and solving for the coefficients using the backslash operator.

$$\begin{aligned}X &= [\text{ones}(\text{size}(x_1)) \ x_1 \ x_2]; \\a &= X \setminus y\end{aligned}$$

$$\begin{aligned}a &= \\& \quad 0.1018 \\& \quad 0.4844 \\& \quad -0.2847\end{aligned}$$

The least squares fit model of the data is

$$y = 0.1018 + 0.4844 x_1 - 0.2847 x_2$$

To validate the model, find the maximum of the absolute value of the deviation of the data from the model.

$$\begin{aligned}Y &= X * a; \\MaxErr &= \max(\text{abs}(Y - y))\end{aligned}$$

$$\begin{aligned}MaxErr &= \\& \quad 0.0038\end{aligned}$$

This is sufficiently small to be confident the model reasonably fits the data.

Case Study: Curve Fitting

This section provides an overview of some of MATLAB's basic data analysis capabilities in the form of a case study. The examples that follow work with a collection of census data, using MATLAB functions to experiment with fitting curves to the data:

- Polynomial fit
- Analyzing residuals
- Exponential fit
- Error bounds

This section also tells you how to use the Basic Fitting interface to perform curve fitting tasks.

Loading the Data

The file `census.mat` contains U.S. population data for the years 1790 through 1990. Load it into MATLAB.

```
load census
```

Your workspace now contains two new variables, `cdate` and `pop`:

- `cdate` is a column vector containing the years from 1790 to 1990 in increments of 10.
- `pop` is a column vector with the U.S. population figures that correspond to the years in `cdate`.

Polynomial Fit

A first try in fitting the census data might be a simple polynomial fit. Two MATLAB functions help with this process.

Curve Fitting Function Summary

Function	Description
<code>polyfit</code>	Polynomial curve fit.
<code>polyval</code>	Evaluation of polynomial fit.

MATLAB's `polyfit` function generates a “best fit” polynomial (in the least squares sense) of a specified order for a given set of data. For a polynomial fit of the fourth-order

```
p = polyfit(cdate,pop,4)
Warning: Polynomial is badly conditioned. Remove repeated data
points or try centering and scaling as described in HELP POLYFIT.
```

```
p =
    1.0e+05 *
    0.0000   -0.0000    0.0000   -0.0126    6.0020
```

The warning arises because the `polyfit` function uses the `cdate` values as the basis for a matrix with very large values (it creates a Vandermonde matrix in its calculations – see the `polyfit` M-file for details). The spread of the `cdate` values results in scaling problems. One way to deal with this is to normalize the `cdate` data.

Preprocessing: Normalizing the Data

Normalization is a process of scaling the numbers in a data set to improve the accuracy of the subsequent numeric computations. A way to normalize `cdate` is to center it at zero mean and scale it to unit standard deviation.

```
sdate = (cdate - mean(cdate))./std(cdate)
```

Now try the fourth-degree polynomial model using the normalized data.

```
p = polyfit(sdate,pop,4)

p =
    0.7047    0.9210   23.4706   73.8598   62.2285
```

Evaluate the fitted polynomial at the normalized year values, and plot the fit against the observed data points.

```
pop4 = polyval(p,sdate);
plot(cdate,pop4,'-',cdate,pop,'+'), grid on
```

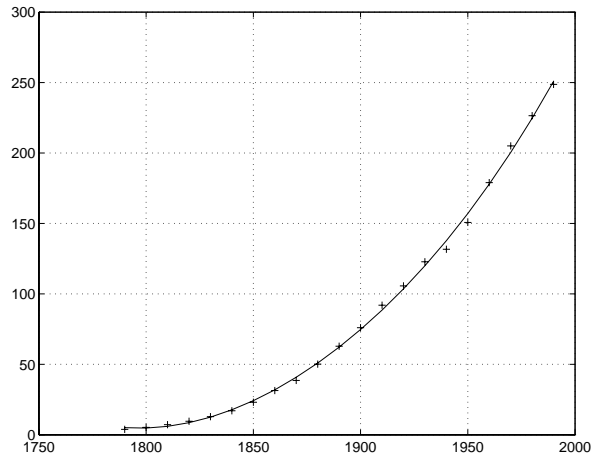

Another way to normalize data is to use some knowledge of the solution and units. For example, with this data set, choosing 1790 to be year zero would also have produced satisfactory results.

Analyzing Residuals

A measure of the “goodness” of fit is the *residual*, the difference between the observed and predicted data. Compare the residuals for the various fits, using normalized cdate values. It’s evident from studying the fit plots and residuals that it should be possible to do better than a simple polynomial fit with this data set.

Comparison Plots of Fit and Residual

Fit

```
p1 = polyfit(sdate,pop,1);
pop1 = polyval(p1,sdate);
plot(cdate,pop1,'b-',cdate,pop,'g+')
```

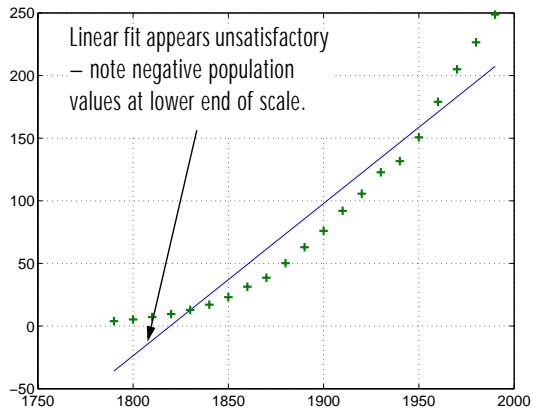

Residuals

```
res1 = pop - pop1;
figure, plot(cdate,res1,'g+')
```

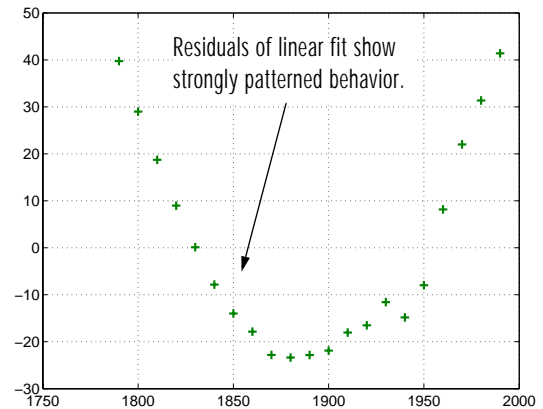

```
p = polyfit(sdate,pop,2);
pop2 = polyval(p,sdate);
plot(cdate,pop2,'b-',cdate,pop,'g+')
```

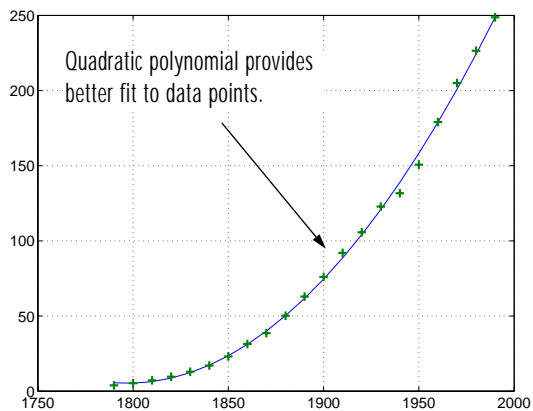

```
res2 = pop - pop2;
figure, plot(cdate,res2,'g+')
```

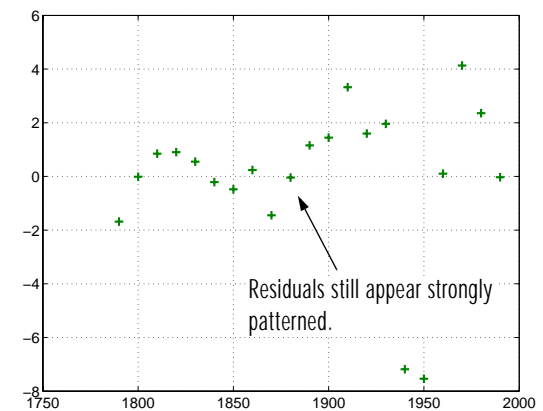

Comparison Plots of Fit and Residual (Continued)

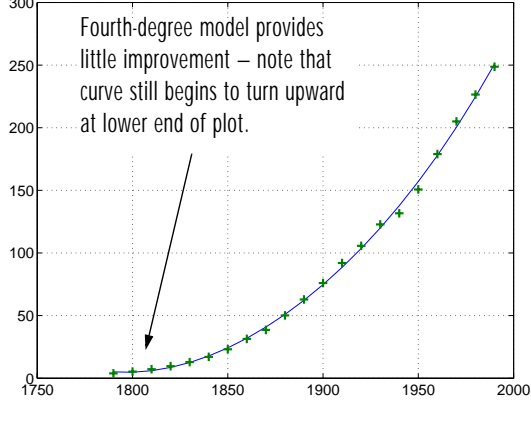
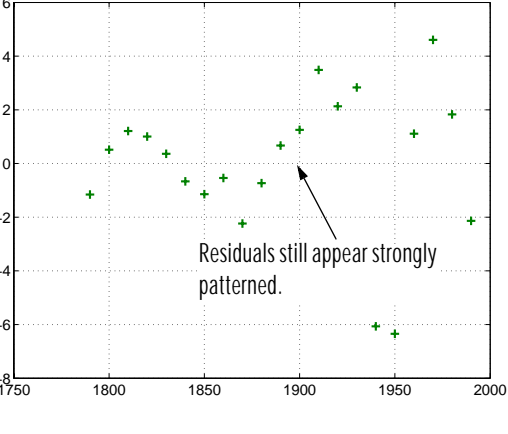
Fit	Residuals
<pre>p = polyfit(sdate,pop,4); pop4 = polyval(p,sdate); plot(cdate,pop4,'b-',cdate,pop,'g+')</pre>	<pre>res4 = pop - pop4; figure, plot(cdate,res4,'g+')</pre>
 <p>Fourth-degree model provides little improvement - note that curve still begins to turn upward at lower end of plot.</p>	 <p>Residuals still appear strongly patterned.</p>

Exponential Fit

By looking at the population data plots on the previous pages, the population data curve is somewhat exponential in appearance. To take advantage of this, let's try to fit the logarithm of the population values, again working with normalized year values.

```
logp1 = polyfit(sdate,log10(pop),1);
logpred1 = 10.^polyval(logp1,sdate);
semilogy(cdate,logpred1,'-',cdate,pop,'+');
grid on
```

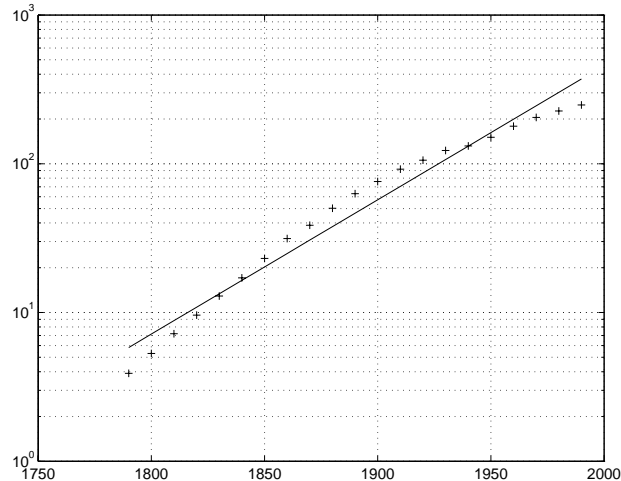

Now try the logarithm analysis with a second-order model.

```
logp2 = polyfit(sdate,log10(pop),2);
logpred2 = 10.^polyval(logp2,sdate);
semilogy(cdate,logpred2,'-',cdate,pop,'+'); grid on
```

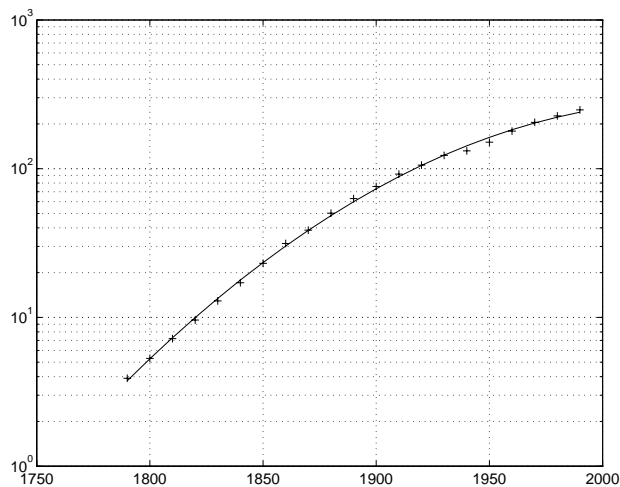

This is a more accurate model. The upper end of the plot appears to taper off, while the polynomial fits in the previous section continue, concave up, to infinity.

Compare the residuals for the second-order logarithmic model.

Residuals in Log Population Scale

```
logres2 = log10(pop) -
polyval(logp2,sdate);
plot(cdate,logres2,'+')
```

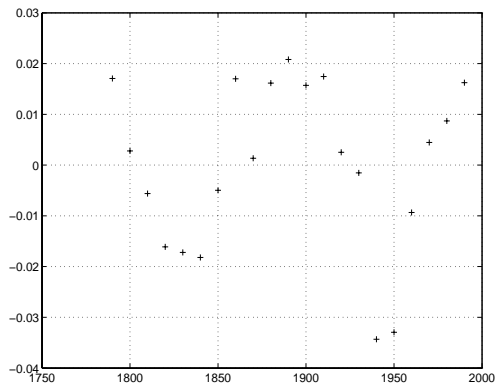

Residuals in Population Scale

```
r = pop - 10.^(polyval(logp2,sdate));
plot(cdate,r,'+')
```

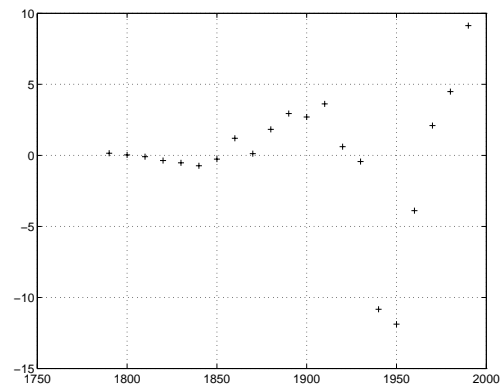

The residuals are more random than for the simple polynomial fit. As might be expected, the residuals tend to get larger in magnitude as the population increases. But overall, the logarithmic model provides a more accurate fit to the population data.

Error Bounds

Error bounds are useful for determining if your data is reasonably modeled by You can obtain the error bounds by passing an optional second output parameter from `polyfit` as an input parameter to `polyval`.

This example uses the census demo data and normalizes the data by centering it at zero mean and scaling it to unit standard deviation. The example then uses `polyfit` and `polyval` to produce error bounds for a second-order polynomial model. Year values are normalized. This code uses an interval of $\pm 2\Delta$, corresponding to a 95% confidence interval.

```
load census
sdate = (cdate - mean(cdate))./std(cdate)

[p2,S2] = polyfit(sdate,pop,2);
[pop2,del2] = polyval(p2,sdate,S2);
plot(cdate,pop,'+',cdate,pop2,'g-',cdate,pop2+2*del2,'r:',...
      cdate,pop2-2*del2,'r:'), grid on
```

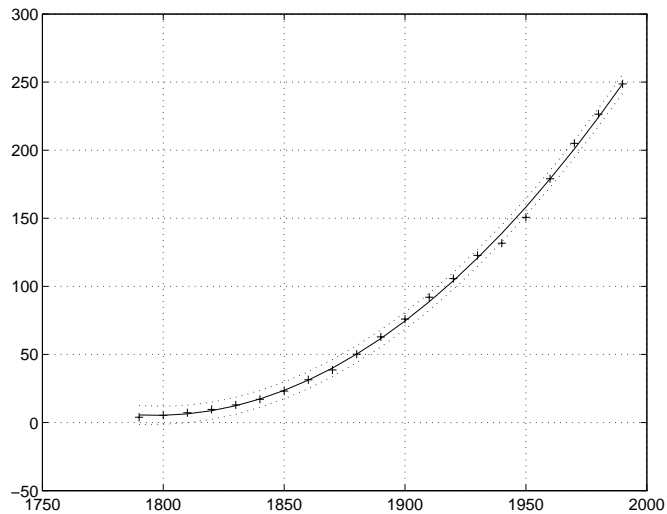

The Basic Fitting Interface

MATLAB supports curve fitting through the Basic Fitting interface. Using this interface, you can quickly perform many curve fitting tasks within the same easy-to-use environment. The interface is designed so that you can:

- Fit data using a spline interpolant, a shape-preserving interpolant, or a polynomial up to degree 10.
- Plot multiple fits simultaneously for a given data set.
- Plot the fit residuals.
- Examine the numerical results of a fit.
- Evaluate (interpolate or extrapolate) a fit.
- Annotate the plot with the numerical fit results and the norm of residuals.
- Save the fit and evaluated results to the MATLAB workspace.

Depending on your specific curve fitting application, you can use the Basic Fitting interface, the command line functionality, or both.

You can use the Basic Fitting interface only with 2-D data. However, if you plot multiple data sets as a subplot, and at least one data set is 2-D, then the interface is enabled.

Note For the HP, IBM, and SGI platforms, the Basic Fitting interface is not supported for Release 12.

Overview of the Basic Fitting Interface

The full Basic Fitting interface is shown below. To reproduce this state, follow these three steps:

- 1 Plot some data.
- 2 Select **Basic Fitting** from the **Tools** menu.
- 3 Click the  button twice.

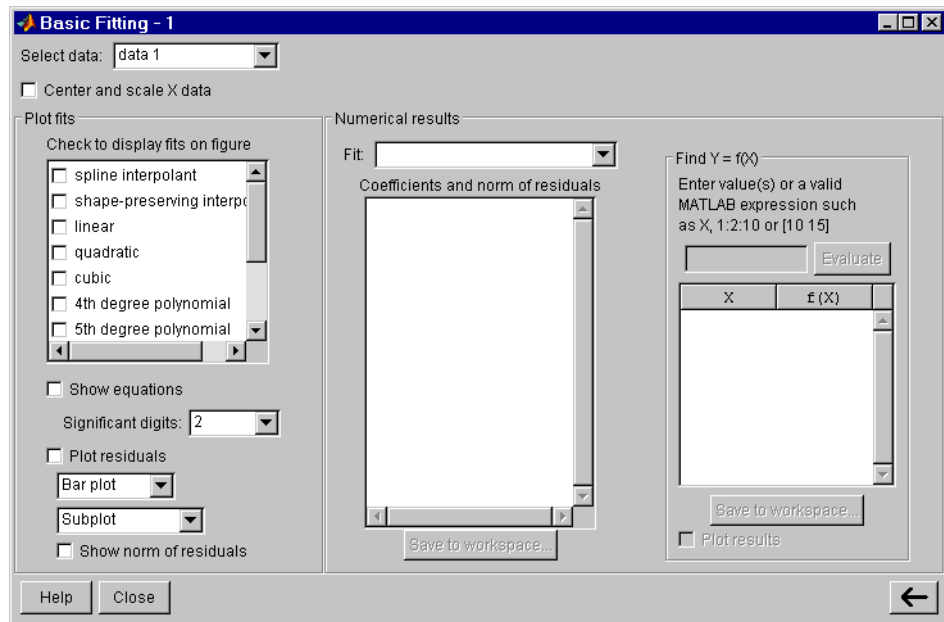

Select data – This parameter list is populated with the names of all the data sets you display in the figure window associated with the Basic Fitting interface.

Use this list to select the current data set. The current data set is defined as the data set that is to be fit. You can fit only one data set at a time. However, you can perform multiple fits for the current data set. Use the Plot Editor to change the name of a data set.

Center and scale X data – If checked, the data is centered at zero mean and scaled to unit standard deviation. You may need to center and scale your data to improve the accuracy of the subsequent numerical computations. A warning is displayed if a fit produces results that may be inaccurate.

Plot fits – This panel allows you to visually explore one or more fits to the current data set:

- **Check to display fits on figure** – Select the fits you want to display for the current data set. There are two types of fits to choose from: interpolants and polynomials. The spline interpolant uses the `spline` function, while the

shape-preserving interpolant uses the `pchip` function. Refer to the `pchip` online help for a comparison of these two functions. The polynomial fits use the `polyfit` function. You can choose as many fits for a given data set as you want.

If your data set has N points, then you should use polynomials with, at most, N coefficients. If your fit uses polynomials with more than N coefficients, the interface automatically sets a sufficient number of coefficients to 0 during the calculation so that the system is not underdetermined.

- **Show equations** – If checked, the fit equation is displayed on the plot.
 - **Significant digits** – Select the significant digits associated with the equation display.
- **Plot residuals** – If checked, the fit residuals are displayed. The fit residuals are defined as the difference between the ordinate data point and the resulting fit for each abscissa data point. You can display the residuals as a bar plot, as a scatter plot, or as a line plot in the same figure window as the data or in a separate figure window. If you use subplots to plot multiple data sets, then residuals can be plotted only in a separate figure window.
 - **Show norm of residuals** – If checked, the norm of residuals are displayed. The norm of residuals is a measure of the goodness of fit, where a smaller value indicates a better fit than a larger value. It is calculated using the `norm` function, `norm(V, 2)`, where V is the vector of residuals.

Numerical results – This panel allows you to explore the numerical results of a single fit to the current data set without plotting the fit:

- **Fit** – Select the equation to fit to the current data set. The fit results are displayed in the list box below the menu. Note that selecting an equation in this menu does not affect the state of the **Plot fits** panel. Therefore, if you want to display the fit in the data plot, you may need to select the associated check box in **Plot fits**.
- **Coefficients and norm of residuals** – Display the numerical results for the equation selected in **Fit**. Note that when you first open the **Numerical Results** panel, the results of the last fit you selected in **Plot fits** are displayed.
- **Save to workspace** – Launch a dialog box that allows you to save the fit results to workspace variables.
- **Find $Y = f(X)$** – Interpolate or extrapolate the current fit.

- **Enter value(s)** – Enter a MATLAB expression to evaluate for the current fit. The expression is evaluated after you press the **Evaluate** button, and the results are displayed in the associated table. The current fit is displayed in the **Fit** menu.
- **Save to workspace** – Launch a dialog box that allows you to save the evaluated results to workspace variables.
- **Plot results** – If checked, the evaluated results are displayed on the data plot.

Example: Using the Basic Fitting Interface

This example illustrates the features of the Basic Fitting interface by fitting a cubic polynomial to the census data. You may want to repeat this example using different equations and compare results. To launch the interface:

1 Plot some data.

```
plot(cdate,pop,'ro')
```

2 Select **Basic Fitting** from the **Tools** menu in the figure.

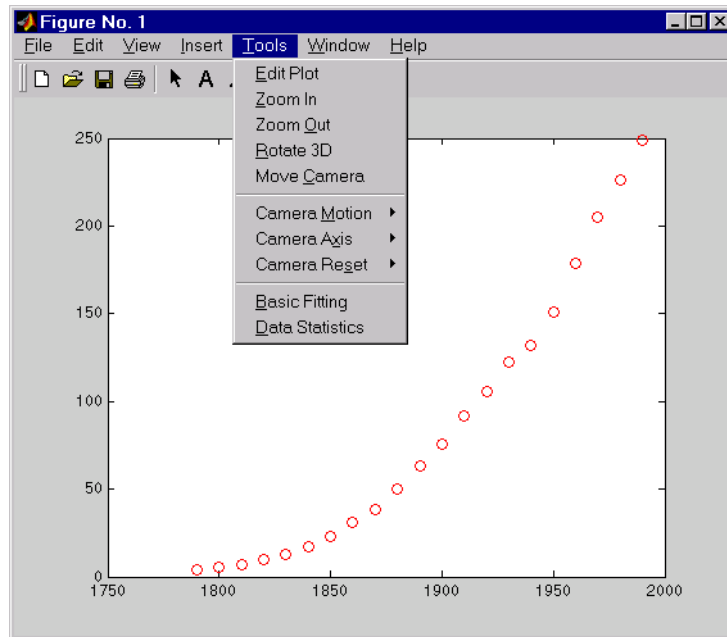

Configure the Basic Fitting interface to:

- Fit a cubic polynomial to the data.
- Display the equation in the data plot.
- Plot the fit residuals as a bar plot, and display the residuals as a subplot of the data figure window.
- Display the norm of the residuals.

This configuration is shown below.

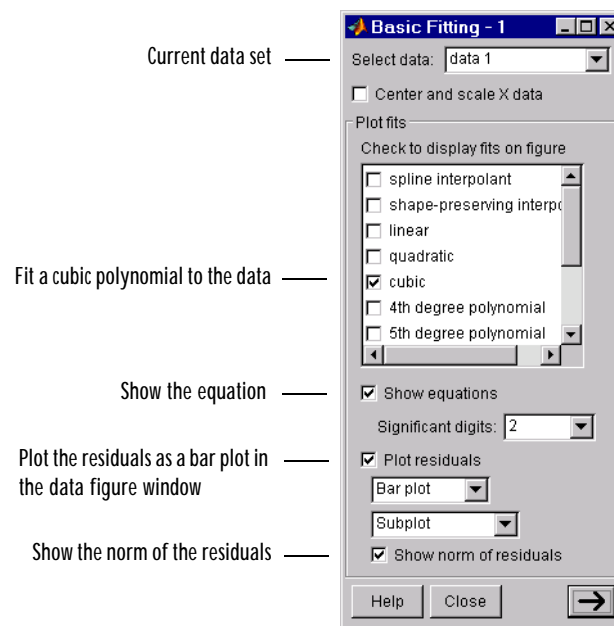

The **Plot fits** panel allows you to visually explore multiple fits to the current data set. For comparison, try fitting additional equations to the census data by selecting the appropriate check boxes. If an equation produces results that may be numerically inaccurate, a warning is displayed. In this case, you should select the **Center and scale X data** check box to improve the numerical accuracy.

The resulting fit and the residuals are shown below.

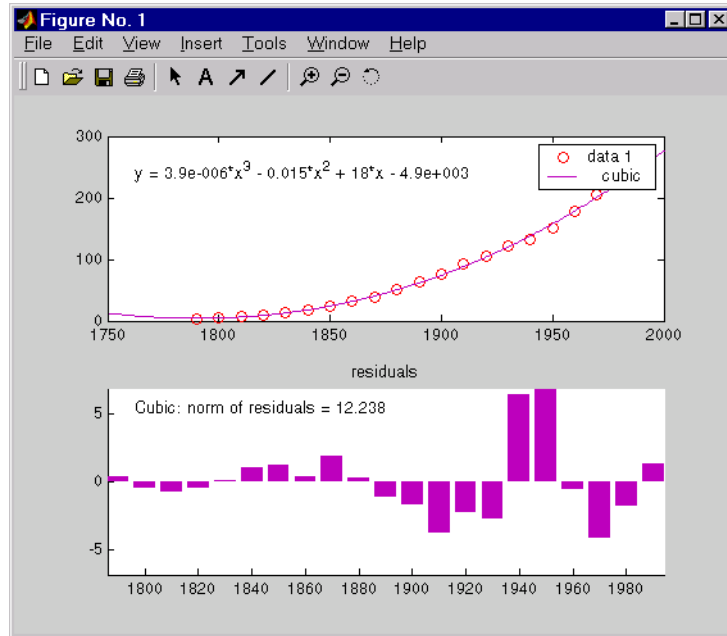

The plot legend indicates the name of the data set and the equation. The legend is automatically updated as you add or remove data sets or fits. Additionally, fits are displayed using a default set of line styles and colors. You can change any of the default plot settings using the Plot Editor. However, any changes you make are undone if you subsequently perform another fit. To retain changes, you should wait until after you have finished fitting your data.

Note If you change the name of a data set in the legend, then the name is automatically changed in the **Select data** menu.

By selecting the  button, you can examine the fit coefficients and the norm of the residuals.

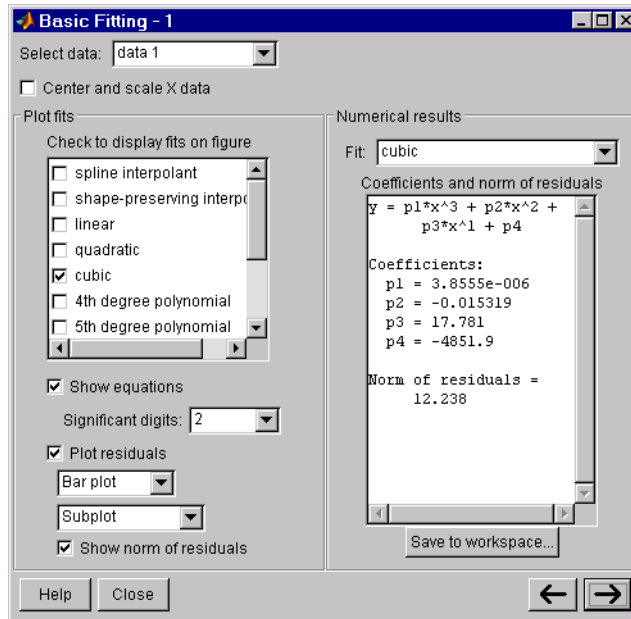

The **Fit** menu allows you to explore numerical fit results for the current data set without plotting the fit. For comparison, you can display the numerical results for other fits by selecting the desired equation. Note that if you want to display a fit in the data plot, you have to select the associated check box in **Plot fits**.

You can save the fit results to the MATLAB workspace by selecting the **Save to workspace** button.

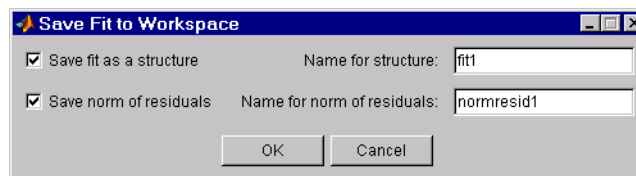

The fit structure is shown below.

```
fit1
fit1 =
    type: 'polynomial degree 3'
    coeff: [3.8555e-006 -0.0153 17.7815 -4.8519e+003]
```

You may want to use this structure for subsequent display or analysis. For example, you can use the saved coefficients and the `polyval` function to evaluate the cubic polynomial at the command line.

By selecting the  button again, you can evaluate the current fit at the specified abscissa values. The current fit is displayed in the **Fit** menu. In this example, the population for the years 2000 to 2050 is evaluated in increments of 10, and then displayed in the data plot.

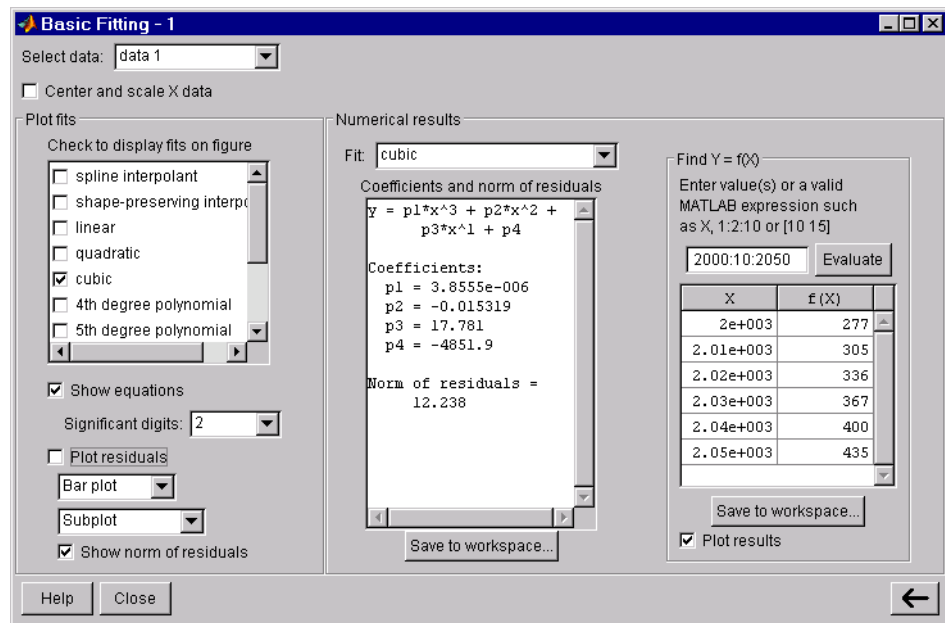

The evaluated data is shown below.

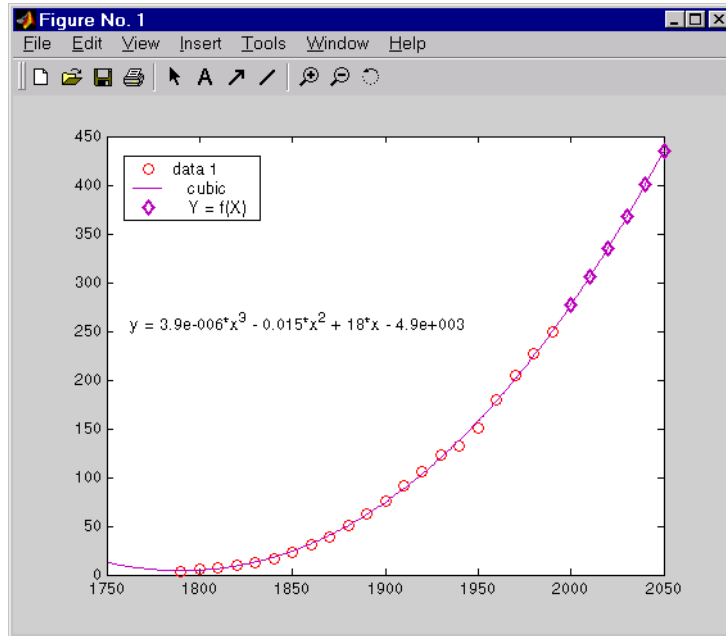

You can save the evaluated data to the MATLAB workspace by selecting the **Save to workspace** button.

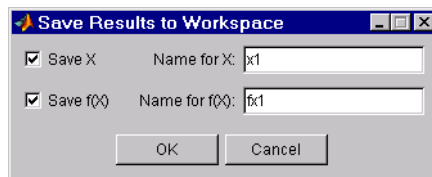

Difference Equations and Filtering

MATLAB has functions for working with difference equations and filters. These functions operate primarily on vectors.

Vectors are used to hold sampled-data signals, or sequences, for signal processing and data analysis. For multi-input systems, each row of a matrix corresponds to a sample point with each input appearing as columns of the matrix.

The function

$$y = \text{filter}(b,a,x)$$

processes the data in vector x with the filter described by vectors a and b , creating filtered data y .

The `filter` command can be thought of as an efficient implementation of the difference equation. The filter structure is the general tapped delay-line filter described by the difference equation below, where n is the index of the current sample, na is the order of the polynomial described by vector a and nb is the order of the polynomial described by vector b . The output $y(n)$, is a linear combination of current and previous inputs, $x(n)$ $x(n-1)$..., and previous outputs, $y(n-1)$ $y(n-2)$...

$$a(1)y(n) = b(1)x(n) + b(2)x(n-1) + \dots + b(nb)x(n-nb+1) \\ - a(2)y(n-1) - \dots - a(na)y(n-na+1)$$

Suppose, for example, we want to smooth our traffic count data with a moving average filter to see the average traffic flow over a 4-hour window. This process is represented by the difference equation

$$y(n) = \frac{1}{4}x(n) + \frac{1}{4}x(n-1) + \frac{1}{4}x(n-2) + \frac{1}{4}x(n-3)$$

The corresponding vectors are

$$a = 1; \\ b = [1/4 \ 1/4 \ 1/4 \ 1/4];$$

Note Enter the format command, `format rat`, to display and enter data using the rational format.

Executing the command

```
load count.dat
```

creates the matrix `count` in the workspace.

For this example, extract the first column of traffic counts and assign it to the vector `x`.

```
x = count(:,1);
```

The 4-hour moving-average of the data is efficiently calculated with

```
y = filter(b,a,x);
```

Compare the original data and the smoothed data with an overlaid plot of the two curves.

```
t = 1:length(x);  
plot(t,x,'-.',t,y,'-'), grid on  
legend('Original Data','Smoothed Data',2)
```

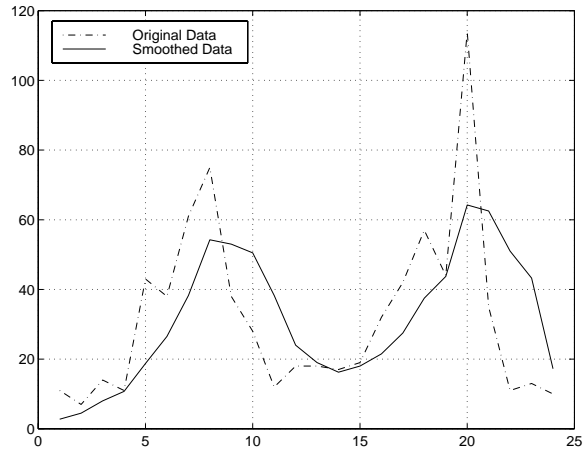

The filtered data represented by the solid line is the 4-hour moving average of the observed traffic count data represented by the dashed line.

For practical filtering applications, the Signal Processing Toolbox includes numerous functions for designing and analyzing filters.

Fourier Analysis and the Fast Fourier Transform (FFT)

Fourier analysis is extremely useful for data analysis, as it breaks down a signal into constituent sinusoids of different frequencies. For sampled vector data, Fourier analysis is performed using the discrete Fourier transform (DFT).

The fast Fourier transform (FFT) is an efficient algorithm for computing the DFT of a sequence; it is not a separate transform. It is particularly useful in areas such as signal and image processing, where its uses range from filtering, convolution, and frequency analysis to power spectrum estimation.

This section:

- Summarizes the Fourier transform functions
- Introduces Fourier transform analysis with an example about sunspot activity
- Calculates magnitude and phase of transformed data
- Discusses the dependence of execution time on length of the transform

Function Summary

MATLAB provides a collection of functions for computing and working with Fourier transforms.

FFT Function Summary

Function	Description
<code>fft</code>	Discrete Fourier transform.
<code>fft2</code>	Two-dimensional discrete Fourier transform.
<code>fftn</code>	N-dimensional discrete Fourier transform.
<code>ifft</code>	Inverse discrete Fourier transform.
<code>ifft2</code>	Two-dimensional inverse discrete Fourier transform.
<code>ifftn</code>	N-dimensional inverse discrete Fourier transform.
<code>abs</code>	Magnitude.

FFT Function Summary (Continued)

Function	Description
angle	Phase angle.
unwrap	Unwrap phase angle in radians.
fftshift	Move zeroth lag to center of spectrum.
cplxpair	Sort numbers into complex conjugate pairs.
nextpow2	Next higher power of two.

Introduction

For length N input sequence x , the DFT is a length N vector, X . `fft` and `ifft` implement the relationships

$$X(k) = \sum_{n=1}^N x(n) e^{-j2\pi(k-1)\left(\frac{n-1}{N}\right)} \quad 1 \leq k \leq N$$

$$x(n) = \frac{1}{N} \sum_{k=1}^N X(k) e^{j2\pi(k-1)\left(\frac{n-1}{N}\right)} \quad 1 \leq n \leq N$$

Note Since the first element of a MATLAB vector has an index 1, the summations in the equations above are from 1 to N . These produce identical results as traditional Fourier equations with summations from 0 to $N-1$.

If $x(n)$ is real, we can rewrite the above equation in terms of a summation of sine and cosine functions with real coefficients

$$x(n) = \frac{1}{N} \sum_{k=1}^N a(k) \cos\left(\frac{2\pi(k-1)(n-1)}{N}\right) + b(k) \sin\left(\frac{2\pi(k-1)(n-1)}{N}\right)$$

where

$$a(k) = \text{real}(X(k)), \quad b(k) = -\text{imag}(X(k)), \quad 1 \leq n \leq N$$

Finding an FFT

The FFT of a column vector x

$$x = [4 \ 3 \ 7 \ -9 \ 1 \ 0 \ 0 \ 0]';$$

is found with

$$y = \text{fft}(x)$$

which results in

$$y = \begin{array}{l} 6.0000 \\ 11.4853 - 2.7574i \\ -2.0000 - 12.0000i \\ -5.4853 + 11.2426i \\ 18.0000 \\ -5.4853 - 11.2426i \\ -2.0000 + 12.0000i \\ 11.4853 + 2.7574i \end{array}$$

Notice that although the sequence x is real, y is complex. The first component of the transformed data is the constant contribution and the fifth element corresponds to the Nyquist frequency. The last three values of y correspond to negative frequencies and, for the real sequence x , they are complex conjugates of three components in the first half of y .

Example: Using FFT to Calculate Sunspot Periodicity

Suppose, we want to analyze the variations in sunspot activity over the last 300 years. You are probably aware that sunspot activity is cyclical, reaching a maximum about every 11 years. Let's confirm that.

Astronomers have tabulated a quantity called the Wolfer number for almost 300 years. This quantity measures both number and size of sunspots.

Load and plot the sunspot data.

```
load sunspot.dat
year = sunspot(:,1);
```

```
wolfer = sunspot(:,2);
plot(year,wolfer)
title('Sunspot Data')
```

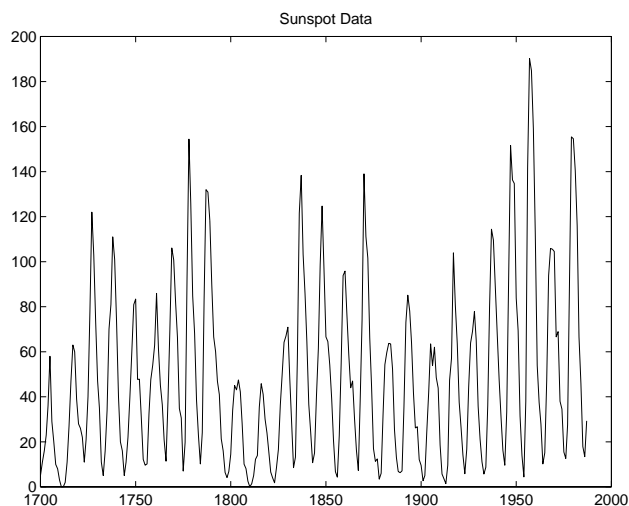

Now take the FFT of the sunspot data.

```
Y = fft(wolfer);
```

The result of this transform is the complex vector, Y . The magnitude of Y squared is called the power and a plot of power versus frequency is a “periodogram.” Remove the first component of Y , which is simply the sum of the data, and plot the results.

```
N = length(Y);
Y(1) = [];
power = abs(Y(1:N/2)).^2;
nyquist = 1/2;
freq = (1:N/2)/(N/2)*nyquist;
plot(freq,power), grid on
xlabel('cycles/year')
title('Periodogram')
```

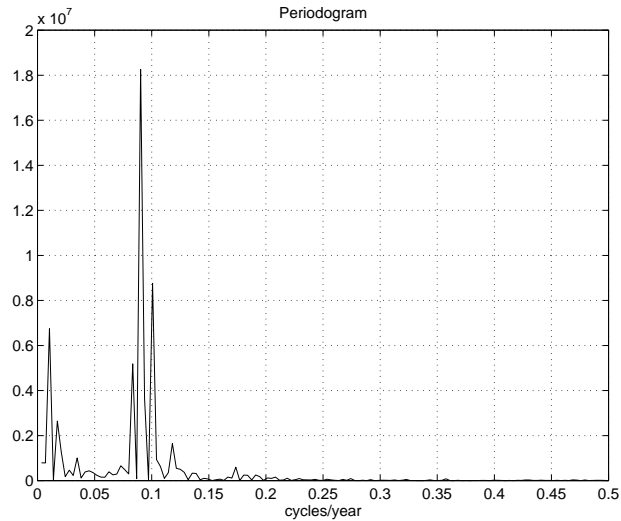

The scale in cycles/year is somewhat inconvenient. Let's plot in years/cycle and estimate what one cycle is. For convenience, plot the power versus period (where period = 1./freq) from 0 to 40 years/cycle.

```
period = 1./freq;  
plot(period,power), axis([0 40 0 2e7]), grid on  
ylabel('Power')  
xlabel('Period(Years/Cycle)')
```

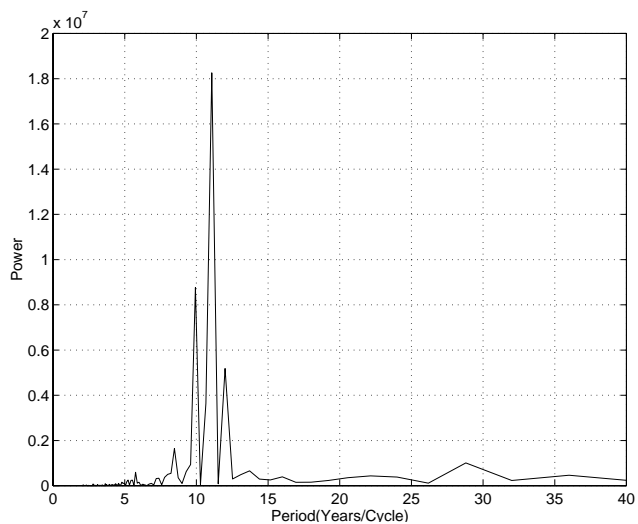

In order to determine the cycle more precisely,

```
[mp,index] = max(power);  
period(index)
```

```
ans =  
    11.0769
```

Magnitude and Phase of Transformed Data

Important information about a transformed sequence includes its magnitude and phase. The MATLAB functions `abs` and `angle` calculate this information.

To try this, create a time vector `t`, and use this vector to create a sequence `x` consisting of two sinusoids at different frequencies.

```
t = 0:1/100:10-1/100;  
x = sin(2*pi*15*t) + sin(2*pi*40*t);
```

Now use the `fft` function to compute the DFT of the sequence. The code below calculates the magnitude and phase of the transformed sequence. It uses the `abs` function to obtain the magnitude of the data, the `angle` function to obtain the phase information, and `unwrap` to remove phase jumps greater than π to their 2π complement.

```
y = fft(x);  
m = abs(y);  
p = unwrap(angle(y));
```

Now create a frequency vector for the x -axis and plot the magnitude and phase.

```
f = (0:length(y)-1)'*100/length(y);  
subplot(2,1,1), plot(f,m),  
ylabel('Abs. Magnitude'), grid on  
subplot(2,1,2), plot(f,p*180/pi)  
ylabel('Phase [Degrees]'), grid on  
xlabel('Frequency [Hertz]')
```

The magnitude plot is perfectly symmetrical about the Nyquist frequency of 50 hertz. The useful information in the signal is found in the range 0 to 50 hertz.

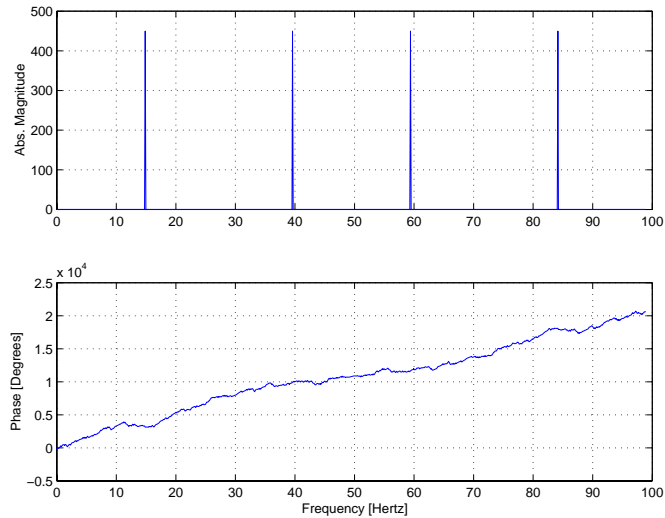

FFT Length Versus Speed

You can add a second argument to `fft` to specify a number of points `n` for the transform

$$y = \text{fft}(x, n)$$

With this syntax, `fft` pads `x` with zeros if it is shorter than `n`, or truncates it if it is longer than `n`. If you do not specify `n`, `fft` defaults to the length of the input sequence.

The execution time for `fft` depends on the length of the transform. It is fastest for powers of two. It is almost as fast for lengths that have only small prime factors. It is typically several times slower for lengths that are prime or which have large prime factors.

The inverse FFT function `ifft` also accepts a transform length argument.

For practical application of the FFT, the Signal Processing Toolbox includes numerous functions for spectral analysis.

Function Functions

Function Summary	14-3
Representing Functions in MATLAB	14-4
Plotting Mathematical Functions	14-6
Minimizing Functions and Finding Zeros	14-9
Minimizing Functions of One Variable	14-9
Minimizing Functions of Several Variables	14-10
Setting Minimization Options	14-11
Finding Zeros of Functions	14-12
Tips	14-15
Troubleshooting	14-15
Converting Your Optimization Code to MATLAB Version	
5 Syntax	14-16
Numerical Integration (Quadrature)	14-19
Example: Computing the Length of a Curve	14-19
Example: Double Integration	14-20

All of the functions described in this chapter are called *function functions* because they accept a function as an input arguments. You can pass such a function either as a function handle or as an inline object that defines a mathematical function. The function that is passed in is referred to as the *objective function*.

This chapter includes:

Function Summary

A summary of some function functions

Representing Functions in MATLAB

Some guidelines for representing functions in MATLAB

Plotting Mathematical Functions

A discussion about using `fplot` to plot mathematical functions

Minimizing Functions and Finding Zeros

A discussion of high-level function functions that perform optimization-related tasks

Numerical Integration (Quadrature)

A discussion of the MATLAB quadrature functions

Note See the “Differential Equations” and “Sparse Matrices” chapters for information about the use of other function functions.

Note For information about function handles, see the `function_handle` (@), `func2str`, and `str2func` reference pages, and the “Function Handles” section of “Programming and Data Types” in the MATLAB documentation.

Function Summary

The function functions are located in the MATLAB `funfun` directory.

This table provides a brief description of the functions discussed in this chapter. Related functions are grouped by category.

Function Summary

Category	Function	Description
Plotting	<code>fplot</code>	Plot function.
Optimization and zero finding	<code>fminbnd</code>	Minimize function of one variable with bound constraints.
	<code>fminsearch</code>	Minimize function of several variables.
	<code>fzero</code>	Find zero of function of one variable.
Numerical integration	<code>quad</code>	Numerically evaluate integral, adaptive Simpson quadrature.
	<code>quadl</code>	Numerically evaluate integral, adaptive Lobatto quadrature.
	<code>dblquad</code>	Numerically evaluate double integral.

Representing Functions in MATLAB

MATLAB can represent mathematical functions by expressing them as MATLAB functions in M-files or as inline objects. For example, consider the function

$$f(x) = \frac{1}{(x-0.3)^2 + 0.01} + \frac{1}{(x-0.9)^2 + 0.04} - 6$$

This function can be used as input to any of the function functions.

As MATLAB Functions

You can find the function above in the M-file named `humps.m`.

```
function y = humps(x)
y = 1./((x - 0.3).^2 + 0.01) + 1./((x - 0.9).^2 + 0.04) - 6;
```

To evaluate the function `humps` at 2.0, use `@` to obtain a function handle for `humps`, and then pass the function handle to `feval`.

```
fh = @humps;
feval(fh,2.0)
```

```
ans =
-4.8552
```

As Inline Objects

A second way to represent a mathematical function at the command line is by creating an *inline* object from a string expression. For example, you can create an inline object of the `humps` function

```
f = inline('1./((x-0.3).^2 + 0.01) + 1./((x-0.9).^2 + 0.04)-6');
```

You can then evaluate `f` at 2.0.

```
f(2.0)
ans =
-4.8552
```

You can also create functions of more than one argument with `inline` by specifying the names of the input arguments along with the string expression. For example, the following function has two input arguments `x` and `y`.

```
f= inline('y*sin(x)+x*cos(y)', 'x', 'y')
f(pi,2*pi)
ans =
    3.1416
```

Plotting Mathematical Functions

The `fplot` function plots a mathematical function between a given set of axes limits. You can control the x -axis limits only, or both the x - and y -axis limits. For example, to plot the humps function over the x -axis range $[-5\ 5]$, use

```
fplot(@humps, [-5 5])  
grid on
```

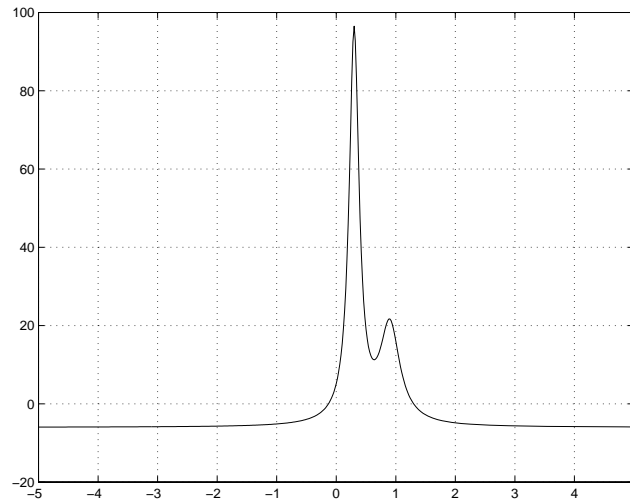

You can zoom in on the function by selecting y -axis limits of -10 and 25 , using

```
fplot(@humps, [-5 5 -10 25])  
grid on
```

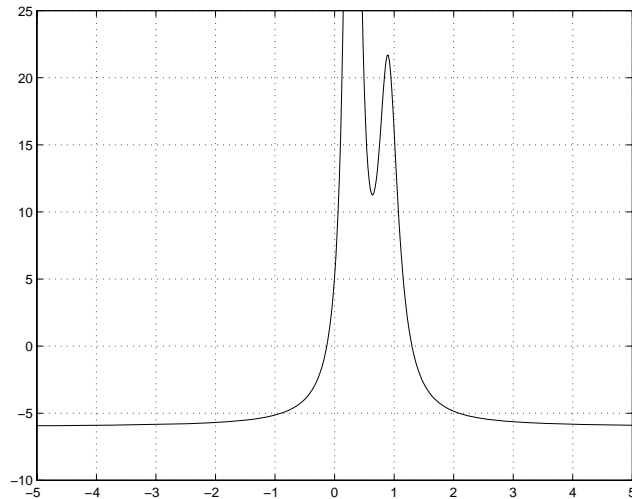
You can also pass an inline for `fplot` to graph, as in

```
fplot(inline('2*sin(x+3)'),[-1 1])
```

You can plot more than one function on the same graph with one call to `fplot`. If you use this with a function, then the function must take a column vector x and return a matrix where each column corresponds to each function, evaluated at each value of x .

If you pass an inline object of several functions to `fplot`, the inline object also must return a matrix where each column corresponds to each function evaluated at each value of x , as in

```
fplot(inline('[2*sin(x+3), humps(x)]'),[-5 5])
```

which plots the first and second functions on the same graph.

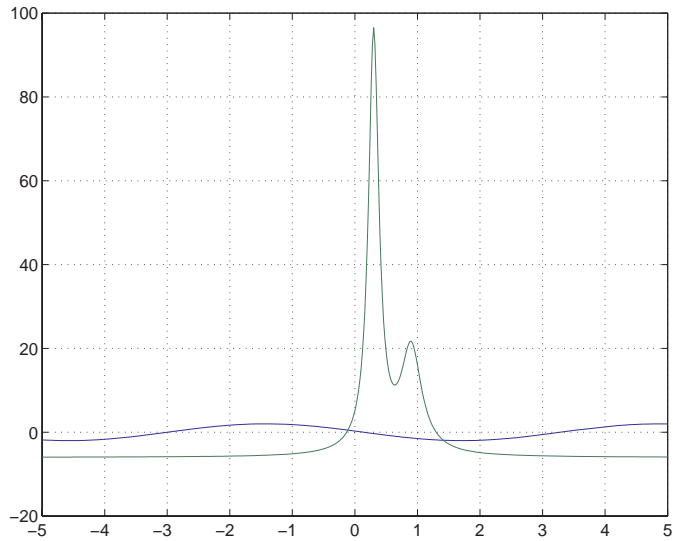

Note that the inline

```
f= inline('[2*sin(x+3), humps(x)]')
```

evaluates to a matrix of two columns, one for each function, when x is a column vector.

```
f([1;2;3])
```

returns

```
-1.5136  16.0000
-1.9178  -4.8552
-0.5588  -5.6383
```

Minimizing Functions and Finding Zeros

MATLAB provides a number of high-level function functions that perform optimization-related tasks. This section describes:

- Minimizing a function of one variable
- Minimizing a function of several variables
- Setting minimization options
- Finding a zero of a function of one variable
- Converting your code to MATLAB Version 5 syntax

The MATLAB optimization functions are:

<code>fminbnd</code>	Minimize a function of one variable on a fixed interval
<code>fminsearch</code>	Minimize a function of several variables
<code>fzero</code>	Find zero of a function of one variable
<code>lsqnonneg</code>	Linear least squares with nonnegativity constraints
<code>optimget</code>	Get optimization options structure parameter values
<code>optimset</code>	Create or edit optimization options parameter structure

For more optimization capabilities, see the Optimization Toolbox.

Minimizing Functions of One Variable

Given a mathematical function of a single variable coded in an M-file, you can use the `fminbnd` function to find a local minimizer of the function in a given interval. For example, to find a minimum of the humps function in the range (0.3, 1), use

```
x = fminbnd(@humps,0.3,1)
```

which returns

```
x =  
    0.6370
```

You can ask for a tabular display of output by passing a fourth argument created by the `optimset` command to `fminbnd`

```
x = fminbnd(@humps,0.3,1,optimset('Display','iter'))
```

which gives the output

Func-count	x	f(x)	Procedure
1	0.567376	12.9098	initial
2	0.732624	13.7746	golden
3	0.465248	25.1714	golden
4	0.644416	11.2693	parabolic
5	0.6413	11.2583	parabolic
6	0.637618	11.2529	parabolic
7	0.636985	11.2528	parabolic
8	0.637019	11.2528	parabolic
9	0.637052	11.2528	parabolic

```
x =
    0.6370
```

This shows the current value of x and the function value at $f(x)$ each time a function evaluation occurs. For `fminbnd`, one function evaluation corresponds to one iteration of the algorithm. The last column shows what procedure is being used at each iteration, either a golden section search or a parabolic interpolation.

Minimizing Functions of Several Variables

The `fminsearch` function is similar to `fminbnd` except that it handles functions of many variables, and you specify a starting vector x_0 rather than a starting interval. `fminsearch` attempts to return a vector x that is a local minimizer of the mathematical function near this starting vector.

To try `fminsearch`, create a function `three_var` of three variables, x , y , and z .

```
function b = three_var(v)
x = v(1);
y = v(2);
z = v(3);
b = x.^2 + 2.5*sin(y) - z^2*x^2*y^2;
```

Now find a minimum for this function using $x = -0.6$, $y = -1.2$, and $z = 0.135$ as the starting values.

```
v = [-0.6 -1.2 0.135];
```

```
a = fminsearch(@three_var,v)

a =
    0.0000   -1.5708    0.1803
```

Setting Minimization Options

You can specify control options that set some minimization parameters by calling `fminbnd` with the syntax

```
x = fminbnd(fun,x1,x2,options)
```

or `fminsearch` with the syntax

```
x = fminsearch(fun,x0,options)
```

`options` is a structure used by the optimization functions. Use `optimset` to set the values of the options structure.

```
options = optimset('Display','iter');
```

`fminbnd` and `fminsearch` use only the options parameters shown in the following table. See the `optimset` reference page for a complete list of the parameters that are used in the Optimization Toolbox.

<code>options.Display</code>	A flag that determines if intermediate steps in the minimization appear on the screen. If set to <code>'iter'</code> , intermediate steps are displayed; if set to <code>'off'</code> , no intermediate solutions are displayed, if set to <code>final</code> , displays just the final output.
<code>options.TolX</code>	The termination tolerance for x . Its default value is $1.e-4$.
<code>options.TolFun</code>	The termination tolerance for the function value. The default value is $1.e-4$. This parameter is used by <code>fminsearch</code> , but not <code>fminbnd</code> .
<code>options.MaxIter</code>	Maximum number of iterations allowed.
<code>options.MaxFunEvals</code>	The maximum number of function evaluations allowed. The default value is 500 for <code>fminbnd</code> and $200*\text{length}(x0)$ for <code>fminsearch</code> .

The number of function evaluations, the number of iterations, and the algorithm are returned in the structure output when you provide `fminbnd` or `fminsearch` with a fourth output argument, as in

```
[x,fval,exitflag,output] = fminbnd(@humps,0.3,1);
```

or

```
[x,fval,exitflag,output] = fminsearch(@three_var,v);
```

Finding Zeros of Functions

The `fzero` function attempts to find a zero of one equation with one variable. You can call this function with either a one-element starting point or a two-element vector that designates a starting interval. If you give `fzero` a starting point x_0 , `fzero` first searches for an interval around this point where the function changes sign. If the interval is found, then `fzero` returns a value near where the function changes sign. If no such interval is found, `fzero` returns NaN. Alternatively, if you know two points where the function value differs in sign, you can specify this starting interval using a two-element vector; `fzero` is guaranteed to narrow down the interval and return a value near a sign change.

Use `fzero` to find a zero of the humps function near -0.2

```
a = fzero(@humps,-0.2)
```

```
a =  
-0.1316
```

For this starting point, `fzero` searches in the neighborhood of -0.2 until it finds a change of sign between -0.10949 and -0.264. This interval is then narrowed down to -0.1316. You can verify that -0.1316 has a function value very close to zero using

```
humps(a)  
  
ans =  
8.8818e -16
```

Suppose you know two places where the function value of `humps` differs in sign such as $x = 1$ and $x = -1$. You can use

```
humps(1)
```

```
ans =
    16

humps(-1)

ans =
   -5.1378
```

Then you can give `fzero` this interval to start with and `fzero` then returns a point near where the function changes sign. You can display information as `fzero` progresses with

```
options = optimset('Display','iter');
a = fzero(@humps,[-1 1],options)
```

Func-count	x	f(x)	Procedure
1	-1	-5.13779	initial
1	1	16	initial
2	-0.513876	-4.02235	interpolation
3	0.243062	71.6382	bisection
4	-0.473635	-3.83767	interpolation
5	-0.115287	0.414441	bisection
6	-0.150214	-0.423446	interpolation
7	-0.132562	-0.0226907	interpolation
8	-0.131666	-0.0011492	interpolation
9	-0.131618	1.88371e-07	interpolation
10	-0.131618	-2.7935e-11	interpolation
11	-0.131618	8.88178e-16	interpolation
12	-0.131618	-9.76996e-15	interpolation

```
a =
   -0.1316
```

The steps of the algorithm include both bisection and interpolation under the Procedure column. If the example had started with a scalar starting point instead of an interval, the first steps after the initial function evaluations would have included some search steps while `fzero` searched for an interval containing a sign change.

You can specify a relative error tolerance using `optimset`. In the call above, passing in the empty matrix causes the default relative error tolerance of `eps` to be used.

Tips

Optimization problems may take many iterations to converge. Most optimization problems benefit from good starting guesses. Providing good starting guesses improves the execution efficiency and may help locate the global minimum instead of a local minimum.

Sophisticated problems are best solved by an evolutionary approach, whereby a problem with a smaller number of independent variables is solved first. Solutions from lower order problems can generally be used as starting points for higher order problems by using an appropriate mapping.

The use of simpler cost functions and less stringent termination criteria in the early stages of an optimization problem can also reduce computation time. Such an approach often produces superior results by avoiding local minima.

Troubleshooting

Below is a list of typical problems and recommendations for dealing with them.

Problem	Recommendation
The solution found by <code>fminbnd</code> or <code>fminsearch</code> does not appear to be a global minimum.	There is no guarantee that you have a global minimum unless your problem is continuous and has only one minimum. Starting the optimization from a number of different starting points (or intervals in the case of <code>fminbnd</code>) may help to locate the global minimum or verify that there is only one minimum. Use different methods, where possible, to verify results.
Sometimes an optimization problem has values of <code>x</code> for which it is impossible to evaluate <code>f</code> .	Modify your function to include a penalty function to give a large positive value to <code>f</code> when infeasibility is encountered.
The minimization routine appears to enter an infinite loop or returns a solution that is not a minimum (or not a zero in the case of <code>fzero</code>).	Your objective function (<code>fun</code>) may be returning <code>Inf</code> , <code>NaN</code> , or complex values. The optimization routines expect only real numbers to be returned. Any other values may cause unexpected results. Insert code into your objective function M-file to verify that only real numbers are returned (use the functions <code>isreal</code> and <code>isfinite</code>).

Converting Your Optimization Code to MATLAB Version 5 Syntax

Most of the function names and calling sequences changed in Version 5 to accommodate new functionality and to clarify the roles of the input and output variables.

This table lists the optimization functions provided by MATLAB and indicates the functions whose names have changed in Version 5.

Old (Version 4) Name	New (Version 5) Name
fmin	fminbnd
fmins	fminsearch
foptions	optimget, optimset
fzero	fzero (name unchanged)
nls	lsqnonneg

This section:

- Tells you how to override default parameter settings with the new `optimset` and `optimget` functions.
- Explains the reasons for the new calling sequences and explains how to convert your code.

In addition to the information in this section, consult the individual function reference pages for information about the new functions and about the arguments they take.

Using `optimset` and `optimget`

The `optimset` function replaces `foptions` for overriding default parameter settings. `optimset` creates an `options` structure that contains parameters used in the optimization routines. If, on the first call to an optimization routine, the `options` structure is not provided, or is empty, a set of default parameters is generated. See the `optimset` reference page for details.

New Calling Sequences

Version 5 of MATLAB makes these changes in the calling sequences:

- Each function takes an options structure to adjust parameters to the optimization functions (see `optimset`, `optimget`).
- The new default output gives information if the function does not converge. (the Version 4 default was no output, Version 5 used 'final' as the default, the new default is `options.display = 'notify'`).
- Each function returns an `exitflag` that describes the termination state.
- Each function now has an output structure that contains information about the problem solution relevant to that function.

The sections below describe how to convert from the old function names and calling sequences to the new ones. The calls shown are the most general cases, involving all possible input and output arguments. Note that many of these arguments are optional. See the function reference pages for more information.

Converting from `fmin` to `fminbnd`. In Version 4, you used this call to `fmin`.

```
[X,OPTIONS] = fmin('FUN',x1,x2,OPTIONS,P1,P2,...);
```

In Version 5, you call `fminbnd` like this.

```
[X,FVAL,EXITFLAG,OUTPUT] = fminbnd(@FUN,x1,x2,...
                                     OPTIONS,P1,P2,...);
```

Converting from `fmins` to `fminsearch`. In Version 4, you used this call to `fmins`.

```
[X,OPTIONS] = fmins('FUN',x0,OPTIONS,[],P1,P2,...);
```

In Version 5, you call `fminsearch` like this.

```
[X,FVAL,EXITFLAG,OUTPUT] = fminsearch(@FUN,x0,...
                                       OPTIONS,P1,P2,...);
```

Converting to the new form of `fzero`. In Version 4, you used this call to `fzero`.

```
X = fzero('F',X,TOL,TRACE,P1,P2,...);
```

In Version 5, replace the TRACE and TOL arguments with

```
if TRACE == 0,  
    val = 'none';  
elseif TRACE == 1  
    val = 'iter';  
end  
OPTIONS = optimset('Display',val,'TolX',TOL);
```

Now call `fzero` like this.

```
[X,FVAL,EXITFLAG,OUTPUT] = fzero(@F,X,OPTIONS,P1,P2,...);
```

Converting from `nls` to `lsqnonneg`. In Version 4, you used this call to `nls`.

```
[X,LAMBDA] = nls(A,b,tol);
```

In Version 5, replace the `tol` argument with

```
OPTIONS = optimset('Display','none','TolX',tol);
```

Now call `lsqnonneg` like this.

```
[X,RESNORM,RESIDUAL,EXITFLAG,OUTPUT,LAMBDA] =  
    lsqnonneg(A,b,X0,OPTIONS);
```

Numerical Integration (Quadrature)

The area beneath a section of a function $F(x)$ can be determined by numerically integrating $F(x)$, a process referred to as *quadrature*. The MATLAB quadrature functions are:

<code>quad</code>	Use adaptive Simpson quadrature
<code>quadl</code>	Use adaptive Lobatto quadrature
<code>dblquad</code>	Numerically evaluate double integral

To integrate the function defined by `humps.m` from 0 to 1, use

```
q = quad(@humps,0,1)

q =
    29.8583
```

Both `quad` and `quadl` operate recursively. If either method detects a possible singularity, it prints a warning.

You can include a fourth argument for `quad` or `quadl` that specifies a relative error tolerance for the integration. If a nonzero fifth argument is passed to `quad` or `quadl`, the function evaluations are traced.

Two examples illustrate use of these functions:

- Computing the length of a curve
- Double integration

Example: Computing the Length of a Curve

You can use `quad` or `quadl` to compute the length of a curve. Consider the curve parameterized by the equations

$$x(t) = \sin(2t), \quad y(t) = \cos(t), \quad z(t) = t$$

where $t \in [0, 3\pi]$.

A three-dimensional plot of this curve is

```
t = 0:0.1:3*pi;
plot3(sin(2*t),cos(t),t)
```

The arc length formula says the length of the curve is the integral of the norm of the derivatives of the parameterized equations

$$\int_0^{3\pi} \sqrt{4\cos(2t)^2 + \sin(t)^2 + 1} dt$$

The function `hcurve` computes the integrand

```
function f = hcurve(t)
    f = sqrt(4*cos(2*t).^2 + sin(t).^2 + 1);
```

Integrate this function with a call to `quad`

```
len = quad(@hcurve,0,3*pi)

len =
    1.7222e+01
```

The length of this curve is about 17.2.

Example: Double Integration

Consider the numerical solution of

$$\int_{ymin}^{ymax} \int_{xmin}^{xmax} f(x,y) dx dy$$

For this example $f(x,y) = y\sin(x) + x\cos(y)$. The first step is to build the function to be evaluated. The function must be capable of returning a vector output when given a vector input. You must also consider which variable is in the inner integral, and which goes in the outer integral. In this example, the inner variable is x and the outer variable is y (the order in the integral is $dx dy$). In this case, the integrand function is

```
function out = integrnd(x,y)
    out = y*sin(x) + x*cos(y);
```

To perform the integration, two functions are available in the `funfun` directory. The first, `dblquad`, is called directly from the command line. This M-file evaluates the outer loop using `quad`. At each iteration, `quad` calls the second helper function that evaluates the inner loop.

To evaluate the double integral, use

```
result = dblquad(@integrnd,xmin,xmax,ymin,ymax);
```

The first argument is a string with the name of the integrand function. The second to fifth arguments are

xmin	Lower limit of inner integral
xmax	Upper limit of the inner integral
ymin	Lower limit of outer integral
ymax	Upper limit of the outer integral

Here is a numeric example that illustrates the use of `dblquad`.

```
xmin = pi;  
xmax = 2*pi;  
ymin = 0;  
ymax = pi;  
result = dblquad(@integrnd,xmin,xmax,ymin,ymax)
```

The result is -9.8698.

By default, `dblquad` calls `quad`. To integrate the previous example using `quad1` (with the default values for the tolerance argument), use

```
result = dblquad(@integrnd,xmin,xmax,ymin,ymax,[],@quad1);
```

Alternatively, any user-defined quadrature function name can be passed to `dblquad` as long as the quadrature function has the same calling and return arguments as `quad`.

Differential Equations

Initial Value Problems for ODEs and DAEs	15-3
ODE Function Summary	15-3
Introduction to Initial Value ODE Problems	15-6
Initial Value Problem Solvers	15-6
Representing ODE Problems	15-10
Improving ODE Solver Performance	15-16
Examples: Applying the ODE Initial Value Problem Solvers	15-31
Questions and Answers, and Troubleshooting	15-50
Boundary Value Problems for ODEs	15-57
BVP Function Summary	15-57
Introduction to Boundary Value ODE Problems	15-59
Boundary Value Problem Solver	15-60
Representing BVP Problems	15-63
Using Continuation to Make a Good Initial Guess	15-68
Improving BVP Solver Performance	15-75
Partial Differential Equations	15-82
PDE Function Summary	15-82
Introduction to PDE Problems	15-83
MATLAB Partial Differential Equation Solver	15-84
Representing PDE Problems	15-88
Improving PDE Solver Performance	15-93
Example: Electrodynamics Problem	15-94
Selected Bibliography	15-99

This chapter treats the numerical solution of differential equations using MATLAB. It includes:

Initial Value Problems for ODEs and DAEs

Describes the solution of ordinary differential equations (ODEs) and differential-algebraic equations (DAEs), where the solution of interest satisfies initial conditions at a given initial value of the independent variable.

Boundary Value Problems for ODEs

Describes the solution of ODEs, where the solution of interest satisfies certain boundary conditions. The boundary conditions specify a relationship between the values of the solution at the initial and final values of the independent variable.

Partial Differential Equations

Describes the solution of initial-boundary value problems for systems of parabolic and elliptic partial differential equations (PDEs) in one spatial variable and time.

Selected Bibliography

Lists published materials that support concepts described in this chapter.

Note In function tables, commonly used functions are listed first, followed by more advanced functions. The same is true of property tables.

Initial Value Problems for ODEs and DAEs

This section describes how to use MATLAB to solve initial value problems (IVPs) of ordinary differential equations (ODEs) and differential-algebraic equations (DAEs). It provides:

- A summary of the MATLAB ODE solvers, related functions, and examples
- An introduction to ODEs and initial value problems
- Descriptions of the ODE solvers and their basic syntax
- General instructions for representing an IVP in MATLAB
- A discussion about changing default integration properties to improve solver performance
- Examples of the kinds of IVP problems you can solve in MATLAB
- Answers to some frequently asked questions about the MATLAB ODE solvers, and some troubleshooting suggestions

ODE Function Summary

Initial Value ODE Problem Solvers

These are the MATLAB initial value problem solvers. The table lists the kind of problem you can solve with each solver, and the method each solver uses.

Solver	Solves These Kinds of Problems	Method
ode45	Nonstiff differential equations	Runge-Kutta
ode23	Nonstiff differential equations	Runge-Kutta
ode113	Nonstiff differential equations	Adams
ode15s	Stiff differential equations and DAEs	NDFs (BDFs)
ode23s	Stiff differential equations	Rosenbrock
ode23t	Moderately stiff differential equations and DAEs	Trapezoidal rule
ode23tb	Stiff differential equations	TR-BDF2

ODE Solution Evaluation

If you call an ODE solver with one output argument, it returns a structure that you can use to evaluate the solution at any point on the interval of integration.

Function	Description
<code>deval</code>	Evaluate the numerical solution using output of ODE solvers.

ODE Option Handling

An options structure contains named integration properties whose values are passed to the solver, and which affect problem solution. Use these functions to create, alter, or access an options structure.

Function	Description
<code>odeset</code>	Create or alter options structure for input to ODE solvers.
<code>odeget</code>	Extract properties from options structure created with <code>odeset</code> .

ODE Solver Output Functions

If an output function is specified, the solver calls the specified function after every successful integration step. You can use `odeset` to specify one of these sample functions as the `OutputFcn` property, or you can modify them to create your own functions.

Function	Description
<code>odeplot</code>	Time-series plot
<code>odephas2</code>	Two-dimensional phase plane plot
<code>odephas3</code>	Three-dimensional phase plane plot
<code>odeprint</code>	Print to command window

ODE Initial Value Problem Examples

These examples illustrate the kinds of problems you can solve in MATLAB. From the MATLAB Help browser, click the example name to see the code in an editor. Type the example name at the command line to run it.

Note The Differential Equations Examples browser enables you to view the code for the ODE examples and DAE examples. You can also run the examples from the browser. Click on these links to invoke the browser, or type `odeexamples('ode')` or `odeexamples('dae')` at the command line.

Example	Description
amp1dae	Stiff DAE – electrical circuit
ballode	Simple event location – bouncing ball
batonode	ODE with time- and state-dependent mass matrix – motion of a baton
brussode	Stiff large problem – diffusion in a chemical reaction (the Brusselator)
burgersode	ODE with strongly state-dependent mass matrix – Burger's equation solved using a moving mesh technique
fem1ode	Stiff problem with a time-dependent mass matrix – finite element method
fem2ode	Stiff problem with a constant mass matrix – finite element method
hb1dae	Stiff DAE from a conservation law
hb1ode	Stiff problem solved on a very long interval – Robertson chemical reaction
orbitode	Advanced event location – restricted three body problem

Example	Description
rigidode	Nonstiff problem – Euler equations of a rigid body without external forces
vdpode	Parameterizable van der Pol equation (stiff for large μ)

Introduction to Initial Value ODE Problems

What Is an Ordinary Differential Equation

The MATLAB ODE solvers are designed to handle *ordinary differential equations*. An ordinary differential equation contains one or more derivatives of a dependent variable y with respect to a single independent variable t , usually referred to as *time*. The derivative of y with respect to t is denoted as y' , the second derivative as y'' , and so on. Often $y(t)$ is a vector, having elements y_1, y_2, \dots, y_n .

Using Initial Conditions to Specify the Solution of Interest

Generally there are many functions $y(t)$ that satisfy a given ODE, and additional information is necessary to specify the solution of interest. In an *initial value problem*, the solution of interest satisfies a specific *initial condition*, that is, y is equal to y_0 at a given initial time t_0 . An initial value problem for an ODE is then

$$\begin{aligned} y' &= f(t, y) \\ y(t_0) &= y_0 \end{aligned} \tag{15-1}$$

If the function $f(t, y)$ is sufficiently smooth, this problem has one and only one solution. Generally there is no analytic expression for the solution, so it is necessary to approximate $y(t)$ by numerical means, such as using one of the MATLAB ODE solvers.

Initial Value Problem Solvers

The MATLAB ODE solver functions implement numerical integration methods for solving IVPs for ODEs (Equation 15-1). Beginning at the initial time with initial conditions, they step through the time interval, computing a solution at each time step. If the solution for a time step satisfies the solver's error

tolerance criteria, it is a successful step. Otherwise, it is a failed attempt; the solver shrinks the step size and tries again.

This section describes:

- MATLAB solvers for nonstiff ODE problems and solvers for stiff ODE problems
- ODE solver basic syntax
- Additional ODE solver arguments

“Mass Matrix and DAE Properties” on page 15-27 explains how to solve more general problems.

You can also use the MATLAB Help browser to get information on the syntax for any MATLAB function, as well as information on example files for these solvers.

Solvers for Nonstiff Problems

There are three solvers designed for nonstiff problems:

- ode45 Based on an explicit Runge-Kutta (4,5) formula, the Dormand-Prince pair. It is a *one-step* solver – in computing $y(t_n)$, it needs only the solution at the immediately preceding time point, $y(t_{n-1})$. In general, ode45 is the best function to apply as a “first try” for most problems.
- ode23 Based on an explicit Runge-Kutta (2,3) pair of Bogacki and Shampine. It may be more efficient than ode45 at crude tolerances and in the presence of mild stiffness. Like ode45, ode23 is a one-step solver.
- ode113 Variable order Adams-Bashforth-Moulton PECE solver. It may be more efficient than ode45 at stringent tolerances and when the ODE function is particularly expensive to evaluate. ode113 is a *multistep* solver – it normally needs the solutions at several preceding time points to compute the current solution.

Solvers for Stiff Problems

Not all difficult problems are stiff, but all stiff problems are difficult for solvers not specifically designed for them. Solvers for stiff problems can be used exactly

like the other solvers. However, you can often significantly improve the efficiency of these solvers by providing them with additional information about the problem. (See “Improving ODE Solver Performance” on page 15-16.)

There are four solvers designed for stiff problems:

- ode15s Variable-order solver based on the numerical differentiation formulas (NDFs). Optionally it uses the backward differentiation formulas, BDFs, (also known as Gear’s method). Like ode113, ode15s is a multistep solver. If you suspect that a problem is stiff or if ode45 failed or was very inefficient, try ode15s.
- ode23s Based on a modified Rosenbrock formula of order 2. Because it is a one-step solver, it may be more efficient than ode15s at crude tolerances. It can solve some kinds of stiff problems for which ode15s is not effective.
- ode23t An implementation of the trapezoidal rule using a “free” interpolant. Use this solver if the problem is only moderately stiff and you need a solution without numerical damping.
- ode23tb An implementation of TR-BDF2, an implicit Runge-Kutta formula with a first stage that is a trapezoidal rule step and a second stage that is a backward differentiation formula of order 2. Like ode23s, this solver may be more efficient than ode15s at crude tolerances.

ODE Solver Basic Syntax

All of the ODE solver functions share a syntax that makes it easy to try any of the different numerical methods if it is not apparent which is the most appropriate. To apply a different method to the same problem, simply change the ODE solver function name. The simplest syntax, common to all the solver functions, is

```
[t,y] = solver(odefun,tspan,y0)
```

where *solver* is one of the ODE solver functions listed previously.

The basic input arguments are:

odefun Function that evaluates the system of ODEs. It has the form

$$dydt = odefun(t,y)$$

where t is a scalar, and $dydt$ and y are column vectors.

tspan Vector specifying the interval of integration. The solver imposes the initial conditions at $tspan(1)$, and integrates from $tspan(1)$ to $tspan(end)$.

For $tspan$ vectors with two elements $[t_0 \ t_f]$, the solver returns the solution evaluated at every integration step. For $tspan$ vectors with more than two elements, the solver returns solutions evaluated at the given time points. The time values must be in order, either increasing or decreasing.

Specifying $tspan$ with more than two elements does not affect the internal time steps that the solver uses to traverse the interval from $tspan(1)$ to $tspan(end)$. All solvers in the MATLAB ODE suite obtain output values by means of continuous extensions of the basic formulas. Although a solver does not necessarily step precisely to a time point specified in $tspan$, the solutions produced at the specified time points are of the same order of accuracy as the solutions computed at the internal time points.

Specifying $tspan$ with more than two elements has little effect on the efficiency of computation, but for large systems, affects memory management.

y0 Vector of initial conditions for the problem

See also “Introduction to Initial Value ODE Problems” on page 15-6.

The output arguments are:

t Column vector of time points

y Solution array. Each row in y corresponds to the solution at a time returned in the corresponding row of t .

Additional ODE Solver Arguments

For more advanced applications, you can also specify as input arguments solver options and additional problem parameters.

options Structure of optional parameters that change the default integration properties. This is the fourth input argument.

```
[t,y] = solver(odefun,tspan,y0,options)
```

“Improving ODE Solver Performance” on page 15-16 tells you how to create the structure and describes the properties you can specify.

p1,p2... Parameters that the solver passes to odefun.

```
[t,y] = solver(odefun,tspan,y0,options,p1,p2...)
```

The solver passes any input parameters that follow the options argument to odefun and any functions you specify in options. Use `options = []` as a placeholder if you set no options. The function odefun must have the form

```
dydt = odefun(t,y,p1,p2,...)
```

See “Passing Additional Parameters to an ODE Function” on page 15-13 for an example.

Representing ODE Problems

This section describes the process for solving initial value ODE problems using one of the MATLAB ODE solvers. It uses the van der Pol equation:

- To describe the steps needed to solve an ODE problem using MATLAB
- As an example of a stiff ODE problem

It also tells you how to evaluate the solution at specific points.

Note See “ODE Solver Basic Syntax” on page 15-8 for more information.

Example: Solving an IVP ODE in MATLAB (van der Pol Equation, Nonstiff)

This example explains and illustrates the steps you need to solve an initial value ODE problem using MATLAB.

1 Rewrite the Problem as a System of First-Order ODEs. ODEs often involve a number of dependent variables, as well as derivatives of order higher than one. To use the MATLAB ODE solvers, you must rewrite such equations as an equivalent system of first-order differential equations of the form

$$y' = f(t, y)$$

You can write any ordinary differential equation

$$y^{(n)} = f(t, y, y', \dots, y^{(n-1)})$$

as a system of first-order equations by making the substitutions

$$y_1 = y, \quad y_2 = y', \quad \dots, \quad y_n = y^{(n-1)}$$

The result is an equivalent system of n first-order ODEs.

$$\begin{aligned} y_1' &= y_2 \\ y_2' &= y_3 \\ &\vdots \\ y_n' &= f(t, y_1, y_2, \dots, y_n) \end{aligned}$$

For example, you can rewrite the van der Pol equation (second-order)

$$y_1'' - \mu(1 - y_1^2)y_1' + y_1 = 0$$

where $\mu > 0$ is a scalar parameter, by making the substitution $y_1' = y_2$. The resulting system of first-order ODEs is

$$\begin{aligned} y_1' &= y_2 \\ y_2' &= \mu(1 - y_1^2)y_2 - y_1 \end{aligned}$$

2 Code the System of First-Order ODEs in MATLAB. Once you represent the equation as a system of first-order ODEs, you can code it as a function that a MATLAB ODE solver can use. The function must be of the form

```
dydt = odefun(t,y)
```

Although t and y must be the function's first two arguments, the function does not need to use them. The output $dydt$, a column vector, is the derivative of y .

The code below represents the van der Pol system in a MATLAB function, `vdp1`. The `vdp1` function assumes that $\mu = 1$. y_1 and y_2 become elements $y(1)$ and $y(2)$ of a two-element vector.

```
function dydt = vdp1(t,y)
dydt = [y(2); (1-y(1)^2)*y(2)-y(1)];
```

Note that, although `vdp1` must accept the arguments t and y , it does not use t in its computations.

3 Apply a Solver to the Problem. Decide which solver you want to use to solve the problem. Then call the solver and pass it the function you created to describe the first-order system of ODEs, the time interval on which you want to solve the problem, and an initial condition vector. See “Initial Value Problem Solvers” on page 15-6 and the ODE solver reference page for descriptions of the ODE solvers.

For the van der Pol system, you can use `ode45` on time interval $[0 \ 20]$ with initial values $y(1) = 2$ and $y(2) = 0$.

```
[t,y] = ode45(@vdp1,[0 20],[2; 0]);
```

This example uses `@` to pass `vdp1` as a function handle to `ode45`. The resulting output is a column vector of time points t and a solution array y . Each row in y corresponds to a time returned in the corresponding row of t . The first column of y corresponds to y_1 , and the second column to y_2 .

Note See the `function_handle (@)`, `func2str`, and `str2func` reference pages, and the Function Handles chapter of “Programming and Data Types” in the MATLAB documentation for information about function handles.

4 View the Solver Output. You can simply use the `plot` command to view the solver output.

```
plot(t,y(:,1),'- ',t,y(:,2),'-- ')
title('Solution of van der Pol Equation, \mu = 1');
```

```

xlabel('time t');
ylabel('solution y');
legend('y_1','y_2')

```

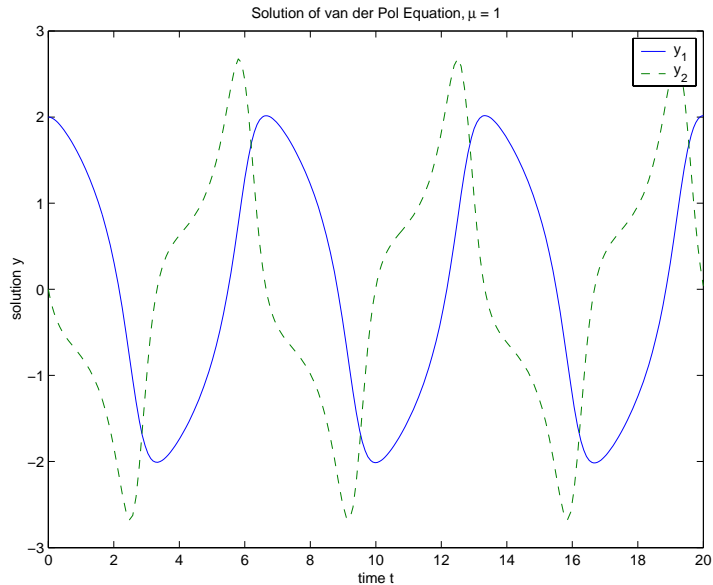

As an alternative, you can use a solver output function to process the output. The solver calls the function specified in the integration property `OutputFcn` after each successful time step. Use `odeset` to set `OutputFcn` to the desired function. See “`OutputFcn`” on page 15-20 for more information.

Passing Additional Parameters to an ODE Function. The solver passes any input parameters that follow the options argument to the ODE function and any function you specify in options. For example:

- 1 Generalize the van der Pol function by passing it a `mu` parameter, instead of specifying a value for `mu` explicitly in the code.

```

function dydt = vdp1(t,y,mu)
dydt = [y(2); mu*(1-y(1)^2)*y(2)-y(1)];

```

- 2 Pass the parameter `mu` to the function `vdp1` by specifying it after the options argument in the call to the solver. This example uses `options = []` as a placeholder.

```
[t,y] = ode45(@vdp1,tspan,y0,[],mu)
```

calls

```
vdp1(t,y,mu)
```

See `vdpode` for a complete example based on these functions.

Example: The van der Pol Equation, $\mu = 1000$ (Stiff)

This example presents a *stiff* problem. For a stiff problem, solutions can change on a time scale that is very short compared to the interval of integration, but the solution of interest changes on a much longer time scale. Methods not designed for stiff problems are ineffective on intervals where the solution changes slowly because they use time steps small enough to resolve the fastest possible change.

When μ is increased to 1000, the solution to the van der Pol equation changes dramatically and exhibits oscillation on a much longer time scale.

Approximating the solution of the initial value problem becomes a more difficult task. Because this particular problem is stiff, a solver intended for nonstiff problems, such as `ode45`, is too inefficient to be practical. A solver such as `ode15s` is intended for such stiff problems.

The `vdp1000` function evaluates the van der Pol system with $\mu = 1000$.

```
function dydt = vdp1000(t,y)
dydt = [y(2); 1000*(1-y(1)^2)*y(2)-y(1)];
```

Note This example hardcodes μ in the ODE function. The `vdpode` example solves the same problem, but passes a user-specified μ as an additional argument to the ODE function. See “Additional ODE Solver Arguments” on page 15-10.

Now use the `ode15s` function to solve the problem with the initial condition vector of $[2; 0]$, but a time interval of $[0 \ 3000]$. For scaling purposes, plot just the first component of $y(t)$.

```
[t,y] = ode15s(@vdp1000,[0 3000],[2; 0]);  
plot(t,y(:,1),'-');  
title('Solution of van der Pol Equation, \mu = 1000');  
xlabel('time t');  
ylabel('solution y_1');
```

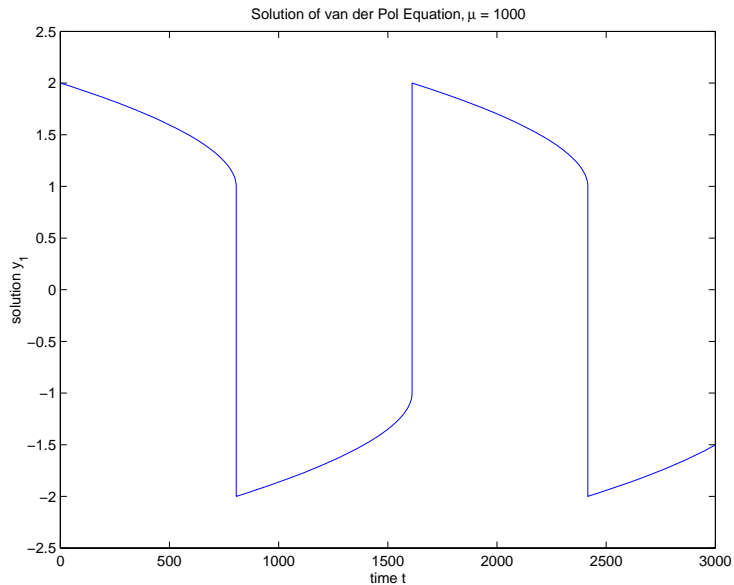

Note For detailed instructions for solving an initial value ODE problem in MATLAB, see “Example: Solving an IVP ODE in MATLAB (van der Pol Equation, Nonstiff)” on page 15-11.

Evaluating the Solution at Specific Points

The numerical methods implemented in the ODE solvers produce a continuous solution over the interval of integration $[a, b]$. You can evaluate the approximate solution, $S(x)$, at any point in $[a, b]$ using the function `deval` and the structure `sol` returned by the solver.

```
Sxint = deval(sol,xint)
```

The ODE solvers return the structure `sol` when called with a single output argument.

The `deval` function is vectorized. For a vector `xint`, the i th column of `Sxint` approximates the solution $y(x_{int}(i))$.

Improving ODE Solver Performance

The default integration properties in the ODE solvers are selected to handle common problems. In some cases, you can improve ODE solver performance by overriding these defaults. You do this by supplying the solvers with one or more property values in an options structure.

```
[t,y] = solver(odefun,tspan,y0,options)
```

This section:

- Explains how to create, modify, and query an options structure.
- Describes the properties that you can use in an options structure.

In this and subsequent property tables, the most commonly used properties are listed first, followed by more advanced properties.

ODE Property Categories

Properties Category	Property Name
Error control	RelTol, AbsTol, NormControl
Solver output	OutputFcn, OutputSel, Refine, Stats
Jacobian matrix	Jacobian, JPattern, Vectorized
Step-size	InitialStep, MaxStep

ODE Property Categories

Properties Category	Property Name
Mass matrix and DAEs	Mass, MStateDependence, MvPattern, MassSingular, InitialSlope
Event location	Events
ode15s-specific	MaxOrder, BDF

Creating and Maintaining an ODE Options Structure

Creating an Options Structure. The `odeset` function creates an options structure that you can pass as an argument to any of the ODE solvers. To create an options structure, `odeset` accepts property name/property value pairs using the syntax

```
options = odeset('name1',value1,'name2',value2,...)
```

In the resulting structure, `options`, the named properties have the specified values. Any unspecified properties contain default values in the solvers. For all properties, it is sufficient to type only the leading characters that uniquely identify the property name. `odeset` ignores case for property names.

With no input arguments, `odeset` displays all property names and their possible values. It indicates defaults with `{}`.

Modifying an Existing Options Structure. To modify an existing options structure, `oldopts`, use

```
options = odeset(oldopts,'name1',value1,...)
```

This sets `options` equal to the existing structure `oldopts`, overwrites any values in `oldopts` that are respecified using name/value pairs, and adds any new pairs to the structure. The modified structure is returned as an output argument. In the same way, the command

```
options = odeset(oldopts,newopts)
```

combines the structures `oldopts` and `newopts`. In the output argument, any values in the second argument overwrite those in the first argument.

Querying Options. The `odeget` function extracts property values from an options structure created with `odeset`.

```
o = odeget(options, 'name')
```

This function returns the value of the specified property, or an empty matrix `[]`, if the property value is unspecified in the options structure.

As with `odeset`, it is sufficient to type only the leading characters that uniquely identify the property name. Case is ignored for property names.

Error Control Properties

At each step, the solver estimates the local error e in the i th component of the solution. This error must be less than or equal to the acceptable error, which is a function of the specified relative tolerance, `RelTol`, and the specified absolute tolerance, `AbsTol`.

$$|e(i)| \leq \max(\text{RelTol} * \text{abs}(y(i)), \text{AbsTol}(i))$$

For routine problems, the ODE solvers deliver accuracy roughly equivalent to the accuracy you request. They deliver less accuracy for problems integrated over “long” intervals and problems that are moderately unstable. Difficult problems may require tighter tolerances than the default values. For relative accuracy, adjust `RelTol`. For the absolute error tolerance, the scaling of the solution components is important: if $|y|$ is somewhat smaller than `AbsTol`, the solver is not constrained to obtain any correct digits in y . You might have to solve a problem more than once to discover the scale of solution components.

Roughly speaking, this means that you want `RelTol` correct digits in all solution components except those smaller than thresholds `AbsTol(i)`. Even if you are not interested in a component $y(i)$ when it is small, you may have to specify `AbsTol(i)` small enough to get some correct digits in $y(i)$ so that you can accurately compute more interesting components

The following table describes the error control properties. Use `odeset` to set the properties.

ODE Error Control Properties

Property	Value	Description
<code>RelTol</code>	Positive scalar $\{1e-3\}$	<p>A relative error tolerance that applies to all components of the solution vector y. It is a measure of the error relative to the size of each solution component. Roughly, it controls the number of correct digits in all solution components except those smaller than thresholds $AbsTol(i)$.</p> <p>The default, $1e-3$, corresponds to 0.1% accuracy.</p>
<code>AbsTol</code>	Positive scalar or vector $\{1e-6\}$	<p>Absolute error tolerances that apply to the individual components of the solution vector. $AbsTol(i)$ is a threshold below which the value of the ith solution component is unimportant. The absolute error tolerances determine the accuracy when the solution approaches zero. Even if you are not interested in a component $y(i)$ when it is small, you may have to specify $AbsTol(i)$ small enough to get some correct digits in $y(i)$ so that you can accurately compute more interesting components.</p> <p>If <code>AbsTol</code> is a vector, the length of <code>AbsTol</code> must be the same as the length of the solution vector y. If <code>AbsTol</code> is a scalar, the value applies to all components of y.</p>
<code>NormControl</code>	<code>on</code> <code>{off}</code>	<p>Control error relative to norm of solution. Set this property <code>on</code> to request that the solvers control the error in each integration step with $\text{norm}(e) \leq \max(\text{RelTol} * \text{norm}(y), \text{AbsTol})$. By default the solvers use a more stringent component-wise error control.</p>

Solver Output Properties

The solver output properties let you control the output that the solvers generate. Use `odeset` to set these properties.

ODE Solver Output Properties

Property	Value	Description
OutputFcn	Function {odeplot}	<p>Installable output function. The solver calls this function after every successful integration step.</p> <p>For example,</p> <pre>options = odeset('OutputFcn',@myfun)</pre> <p>sets the OutputFcn property to an output function, myfun, that can be passed to an ODE solver.</p> <p>The output function must be of the form</p> <pre>status = myfun(t,y,flag)</pre> <p>The solver calls the specified output function with the following flags. Note that the syntax of the call differs with the flag. The function must respond appropriately:</p> <p>init The solver calls <code>myfun(tspan,y0,'init')</code> before beginning the integration to allow the output function to initialize. <code>tspan</code> and <code>y0</code> are the input arguments to the ODE solver.</p>

ODE Solver Output Properties (Continued)

Property	Value	Description
		<p data-bbox="510 343 1326 539">{none} The solver calls <code>status = myfun(t,y)</code> after each integration step on which output is requested. <code>t</code> contains points where output was generated during the step, and <code>y</code> is the numerical solution at the points in <code>t</code>. If <code>t</code> is a vector, the <i>i</i>th column of <code>y</code> corresponds to the <i>i</i>th element of <code>t</code>.</p> <p data-bbox="644 565 1288 661">When <code>length(tspan) > 2</code> the output is produced at every point in <code>tspan</code>. When <code>length(tspan) = 2</code> the output is produced according to the <code>Refine</code> option.</p> <p data-bbox="644 687 1299 812"><code>myfun</code> must return a status output value of 0 or 1. If <code>status = 1</code>, the solver halts integration. You can use this mechanism, for instance, to implement a Stop button.</p> <p data-bbox="510 838 1307 933">done The solver calls <code>myfun([],[], 'done')</code> when integration is complete to allow the output function to perform any cleanup chores.</p>
		<p data-bbox="510 960 1326 1055">You can use these general purpose output functions or you can edit them to create your own. Type <code>help</code> function at the command line for more information.</p> <ul data-bbox="510 1081 1322 1303" style="list-style-type: none"> • <code>odeplot</code> – time series plotting (default when you call the solver with no output arguments and you have not specified an output function) • <code>odephas2</code> – two-dimensional phase plane plotting • <code>odephas3</code> – three-dimensional phase plane plotting • <code>odeprint</code> – print solution as it is computed <hr/> <p data-bbox="510 1373 1310 1433">Note If you call the solver with no output arguments, the solver does not allocate storage to hold the entire solution history.</p> <hr/>

ODE Solver Output Properties (Continued)

Property	Value	Description
OutputSel	Vector of indices	<p>Vector of indices specifying which components of the solution vector are to be passed to the output function. For example, if you want to use the <code>odeplot</code> output function, but you want to plot only the first and third components of the solution, you can do this using</p> <pre>options = odeset('OutputFcn',@odeplot,'OutputSel',[1 3]);</pre> <p>By default, the solver passes all components of the solution to the output function.</p>
Refine	Positive integer	<p>Increases the number of output points by a factor of <code>Refine</code>. If <code>Refine</code> is 1, the solver returns solutions only at the end of each time step. If <code>Refine</code> is $n > 1$, the solver subdivides each time step into n smaller intervals, and returns solutions at each time point. <code>Refine</code> does not apply when <code>length(tspan) > 2</code>.</p> <hr/> <p>Note In all the solvers, the default value of <code>Refine</code> is 1. Within <code>ode45</code>, however, the default is 4 to compensate for the solver's large step sizes. To override this and see only the time steps chosen by <code>ode45</code>, set <code>Refine</code> to 1.</p> <hr/> <p>The extra values produced for <code>Refine</code> are computed by means of continuous extension formulas. These are specialized formulas used by the ODE solvers to obtain accurate solutions between computed time steps without significant increase in computation time.</p>

ODE Solver Output Properties (Continued)

Property	Value	Description
Stats	on {off}	<p>Specifies whether the solver should display statistics about its computations. By default, Stats is off. If it is on, after solving the problem the solver displays:</p> <ul style="list-style-type: none"> • The number of successful steps • The number of failed attempts • The number of times the ODE function was called to evaluate $f(t, y)$ • The number of times that the partial derivatives matrix $\partial f/\partial y$ was formed • The number of LU decompositions • The number of solutions of linear systems

Jacobian Matrix Properties

The stiff ODE solvers often execute faster if you provide additional information about the Jacobian matrix $\partial f/\partial y$, a matrix of partial derivatives of the function that defines the differential equations.

$$\frac{\partial f}{\partial y} = \begin{bmatrix} \frac{\partial f_1}{\partial y_1} & \frac{\partial f_1}{\partial y_2} & \cdots \\ \frac{\partial f_2}{\partial y_1} & \frac{\partial f_2}{\partial y_2} & \cdots \\ \vdots & \vdots & \ddots \end{bmatrix}$$

The Jacobian matrix properties pertain only to those solvers for stiff problems (ode15s, ode23s, ode23t, and ode23tb) for which the Jacobian matrix $\partial f/\partial y$ can be critical to reliability and efficiency. If you do not provide a function to calculate the Jacobian, these solvers approximate the Jacobian numerically using finite differences. In this case, you may want to use the `Vectorized`, or `JPattern` properties.

The following table describes the Jacobian matrix properties. Use `odeset` to set these properties.

ODE Jacobian Matrix Properties

Property	Value	Description
Jacobian	Function constant matrix	<p>A constant matrix or a function that evaluates the Jacobian. Supplying an analytical Jacobian often increases the speed and reliability of the solution for stiff problems. Set this property to a function <code>FJac</code>, where <code>FJac(t,y)</code> computes $\partial f/\partial y$, or to the constant value of $\partial f/\partial y$.</p> <p>The Jacobian for the stiff van der Pol problem shown above can be coded as</p> <pre>function J = vdp1000jac(t,y) J = [0 1 (-2000*y(1)*y(2)-1) (1000*(1-y(1)^2))];</pre>
JPattern	Sparse matrix of {0,1}	<p>Sparsity pattern with 1s where there might be nonzero entries in the Jacobian. It is used to generate a sparse Jacobian matrix numerically.</p> <p>Set this property to a sparse matrix S with $S(i,j) = 1$ if component i of $f(t,y)$ depends on component j of y, and 0 otherwise. The solver uses this sparsity pattern to generate a sparse Jacobian matrix numerically. If the Jacobian matrix is large and sparse, this can greatly accelerate execution. For an example using the <code>JPattern</code> property, see “Example: Large, Stiff Sparse Problem” on page 15-38 (brussode).</p>

ODE Jacobian Matrix Properties (Continued)

Property	Value	Description
Vectorized	on {off}	<p>Set on to inform the solver that you have coded the ODE function F so that $F(t, [y1 \ y2 \ \dots])$ returns $[F(t, y1) \ F(t, y2) \ \dots]$. This allows the solver to reduce the number of function evaluations required to compute all the columns of the Jacobian matrix, and may significantly reduce solution time.</p> <p>With MATLAB's array notation, it is typically an easy matter to vectorize an ODE function. For example, the stiff van der Pol example shown previously can be vectorized by introducing colon notation into the subscripts and by using the array power (\wedge) and array multiplication (\cdot) operators.</p> <pre>function dydt = vdp1000(t,y) dydt = [y(2,:); 1000*(1-y(1,:).^2).*y(2,:)-y(1,:)];</pre> <hr/> <p>Note Vectorization of the ODE function used by the ODE solvers differs from the vectorization used by the BVP solver, <code>bvp4c</code>. For the ODE solvers, the ODE function is vectorized only with respect to the second argument, while <code>bvp4c</code> requires vectorization with respect the first and second arguments.</p> <hr/>

Step-Size Properties

The step-size properties let you specify the size of the first step the solver tries, potentially helping it to better recognize the scale of the problem. In addition, you can specify bounds on the sizes of subsequent time steps.

The following table describes the step-size properties. Use `odeset` to set these properties.

ODE Step Size Properties

Property	Value	Description
<code>InitialStep</code>	Positive scalar	Suggested initial step size. <code>InitialStep</code> sets an upper bound on the magnitude of the first step size the solver tries. If you do not set <code>InitialStep</code> , the initial step size is based on the slope of the solution at the initial time <code>tspan(1)</code> , and if the slope of all solution components is zero, the procedure might try a step size that is much too large. If you know this is happening or you want to be sure that the solver resolves important behavior at the start of the integration, help the code start by providing a suitable <code>InitialStep</code> .
<code>MaxStep</code>	Positive scalar { <code>0.1*abs(t0-tf)</code> }	Upper bound on solver step size. If the differential equation has periodic coefficients or solutions, it may be a good idea to set <code>MaxStep</code> to some fraction (such as 1/4) of the period. This guarantees that the solver does not enlarge the time step too much and step over a period of interest. Do <i>not</i> reduce <code>MaxStep</code> : <ul style="list-style-type: none"> • To produce more output points. This can significantly slow down solution time. Instead, use <code>Refine</code> to compute additional outputs by continuous extension at very low cost. • When the solution does not appear to be accurate enough. Instead, reduce the relative error tolerance <code>RelTol</code>, and use the solution you just computed to determine appropriate values for the absolute error tolerance vector <code>AbsTol</code>. (See “Error Control Properties” on page 15-18 for a description of the error tolerance properties.)

ODE Step Size Properties (Continued)

Property	Value	Description
		<ul style="list-style-type: none"> To make sure that the solver doesn't step over some behavior that occurs only once during the simulation interval. If you know the time at which the change occurs, break the simulation interval into two pieces and call the solvers twice. If you do not know the time at which the change occurs, try reducing the error tolerances <code>RelTol</code> and <code>AbsTol</code>. Use <code>MaxStep</code> as a last resort.

Mass Matrix and DAE Properties

The solvers of the ODE suite can solve ODEs of the form

$$M(t, y) y' = f(t, y) \quad (15-2)$$

with a mass matrix $M(t, y)$ that can be sparse.

When $M(t, y)$ is nonsingular, the equation above is equivalent to $y' = M^{-1}f(t, y)$ and the ODE has a solution for any initial values y_0 at t_0 . The more general form (Equation 15-2) is convenient when you express a model naturally in terms of a mass matrix. For large, sparse $M(t, y)$, solving Equation 15-2 directly reduces the storage and runtime needed to solve the problem.

When $M(t, y)$ is singular, then $M(t, y) y' = f(t, y)$ is a differential-algebraic equation (DAE). A DAE has a solution only when y_0 is consistent, that is, there exists an initial slope yp_0 such that $M(t_0, y_0)yp_0 = f(t_0, y_0)$. If y_0 and yp_0 are not consistent, the solver treats them as guesses, attempts to compute consistent values that are close to the guesses, and continues to solve the problem. For DAEs of index 1, solving an initial value problem with consistent initial conditions is much like solving an ODE.

The `ode15s` and `ode23t` solvers can solve DAEs of index 1. For examples of DAE problems, see `hb1dae` ("Example: Differential-Algebraic Problem" on page 15-47) and `amp1dae`.

The following table describes the mass matrix and DAE properties. Use `odeset` to set these properties.

ODE Mass Matrix and DAE Properties

Property	Value	Description
Mass	Constant matrix function	<p>Constant mass matrix or a function that evaluates the mass matrix $M(t, y)$. For problems $My' = f(t, y)$ set this property to the value of the constant mass matrix M. For problems $M(t, y)y' = f(t, y)$, set this property to a function <code>Mfun</code>, where <code>Mfun(t, y)</code> evaluates the mass matrix $M(t, y)$. When solving DAEs, it is advantageous to formulate the problem so that M is a diagonal matrix (a semi-explicit DAE). The <code>ode23s</code> solver can only solve problems with a constant mass matrix M.</p> <p>For example problems, see <code>fem1ode</code> (“Example: Finite Element Discretization” on page 15-35), <code>fem2ode</code>, or <code>batonode</code>.</p>
MStateDependence	none {weak} strong	<p>Dependence of the mass matrix on y. Set this property to <code>none</code> for problems $M(t)y' = f(t, y)$. Both <code>weak</code> and <code>strong</code> indicate $M(t, y)$, but <code>weak</code> results in implicit solvers using approximations when solving algebraic equations.</p>
MvPattern	Sparse matrix	<p>$\partial(M(t, y)v)/\partial y$ sparsity pattern. Set this property to a sparse matrix S with $S(i, j) = 1$ if for any k, the (i, k) component of $M(t, y)$ depends on component j of y, and 0 otherwise. For use with the <code>ode15s</code>, <code>ode23t</code>, and <code>ode23tb</code> solvers when <code>MStateDependence</code> is <code>strong</code>. See <code>burgersode</code> as an example.</p>

ODE Mass Matrix and DAE Properties (Continued)

Property	Value	Description
MassSingular	yes no {maybe}	<p>Indicates whether the mass matrix is singular. Set this property to no if the mass matrix is not singular and you are using either the ode15s or ode23t solver. The default value of maybe causes the solver to test whether the problem is a DAE, i.e., whether $M(t_0, y_0)$ is singular.</p> <p>For an example of a problem with a mass matrix, see “Example: Finite Element Discretization” on page 15-35 (fem1ode).</p>
InitialSlope	Vector {zero vector}	<p>Vector representing the consistent initial slope yp_0, where yp_0 satisfies $M(t_0, y_0)yp_0 = f(t_0, y_0)$. The default is the zero vector.</p> <p>This property is for use with the ode15s and ode23t solvers when solving DAEs.</p>

Event Location Property

In some ODE problems the times of specific events are important, such as the time at which a ball hits the ground, or the time at which a spaceship returns to the earth. While solving a problem, the MATLAB ODE solvers can detect such events by locating transitions to, from, or through zeros of user-defined functions.

The following table describes the Events property. Use `odeset` to set this property.

ODE Events Property

String	Value	Description
Events	Function	<p>MATLAB function that includes one or more event functions. The MATLAB function is of the form</p> $[\text{value}, \text{isterminal}, \text{direction}] = \text{events}(t, y)$ <p><code>value</code>, <code>isterminal</code>, and <code>direction</code> are vectors for which the <i>i</i>th element corresponds to the <i>i</i>th event function:</p> <ul style="list-style-type: none"> • <code>value(i)</code> is the value of the <i>i</i>th event function. • <code>isterminal(i) = 1</code> if the integration is to terminate at a zero of this event function and 0 otherwise. • <code>direction(i) = 0</code> if all zeros are to be located (the default), +1 if only zeros where the event function is increasing, and -1 if only zeros where the event function is decreasing. <p>When you specify an events function, the solver returns three additional outputs, <code>TE</code>, <code>YE</code>, and <code>IE</code>.</p> <pre>options = odeset('Events', @events) [T, Y, TE, YE, IE] = solver(odefun, tspan, y0, options)</pre> <ul style="list-style-type: none"> • <code>TE</code> is a column vector of times at which events occur. • Rows of <code>YE</code> are the solution values corresponding to times in <code>TE</code>. • Indices in vector <code>IE</code> specify which event occurred at the time in <code>TE</code>. <p>For examples that use an event function, see “Example: Simple Event Location” on page 15-41 (<code>ballode</code>) and “Example: Advanced Event Location” on page 15-44 (<code>orbitode</code>).</p>

ode15s Properties

`ode15s` is a variable-order solver for stiff problems. It is based on the numerical differentiation formulas (NDFs). The NDFs are generally more efficient than the closely related family of backward differentiation formulas (BDFs), also

known as Gear's methods. The `ode15s` properties let you choose between these formulas, as well as specifying the maximum order for the formula used.

The following table describes the `ode15s` properties. Use `odeset` to set these properties.

ode15s Properties

Property	Value	Description
MaxOrder	1 2 3 4 {5}	The maximum order formula used to compute the solution.
BDF	on {off}	<p>Specifies whether you want to use the BDFs instead of the default NDFs. Set BDF on to have <code>ode15s</code> use the BDFs.</p> <p>For both the NDFs and BDFs, the formulas of orders 1 and 2 are A-stable (the stability region includes the entire left half complex plane). The higher order formulas are not as stable, and the higher the order the worse the stability. There is a class of stiff problems (stiff oscillatory) that is solved more efficiently if MaxOrder is reduced (for example to 2) so that only the most stable formulas are used.</p>

Examples: Applying the ODE Initial Value Problem Solvers

This section contains several examples that illustrate the kinds of problems you can solve in MATLAB:

- Simple nonstiff problem (`rigidode`)
- Stiff problem (`vdpode`)
- Finite element discretization (`fem1ode`)
- Large, stiff sparse problem (`brussode`)
- Simple event location (`ballode`)
- Advanced event location (`orbitode`)
- Differential-algebraic problem (`hb1dae`)

Example: Simple Nonstiff Problem

`rigidode` illustrates the solution of a standard test problem proposed by Krogh for solvers intended for nonstiff problems [7].

The ODEs are the Euler equations of a rigid body without external forces.

$$y_1' = y_2 y_3$$

$$y_2' = -y_1 y_3$$

$$y_3' = -0.51 y_1 y_2$$

For your convenience, the entire problem is defined and solved in a single M-file. The differential equations are coded as a subfunction `f`. Because the example calls the `ode45` solver without output arguments, the solver uses the default output function `odeplot` to plot the solution components.

To run this example from the MATLAB Help browser, click on the example name. Otherwise, type `rigidode` at the command line.

```
function rigidode
%RIGIDODE Euler equations of a rigid body without external forces
tspan = [0 12];
y0 = [0; 1; 1];

% Solve the problem using ode45
ode45(@f,tspan,y0);
% -----
function dydt = f(t,y)
dydt = [ y(2)*y(3)
        -y(1)*y(3)
        -0.51*y(1)*y(2) ];
```

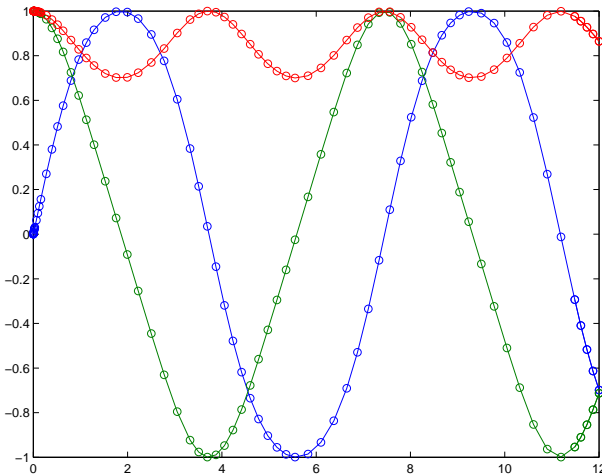
Example: Stiff Problem (van der Pol Equation)

vdode illustrates the solution of the van der Pol problem described in “Example: The van der Pol Equation, $\mu = 1000$ (Stiff)” on page 15-14. The differential equations

$$\begin{aligned} y_1' &= y_2 \\ y_2' &= \mu(1 - y_1^2)y_2 - y_1 \end{aligned}$$

involve a constant parameter μ .

As μ increases, the problem becomes more stiff, and the period of oscillation becomes larger. When μ is 1000 the equation is in relaxation oscillation and the problem is very stiff. The limit cycle has portions where the solution components change slowly and the problem is quite stiff, alternating with regions of very sharp change where it is not stiff (quasi-discontinuities).

By default, the solvers in the ODE suite that are intended for stiff problems approximate Jacobian matrices numerically. However, this example provides a subfunction $J(t, y, \mu)$ to evaluate the Jacobian matrix $\partial f / \partial y$ analytically at

(t, y) for $\mu = \text{mu}$. The use of an analytic Jacobian can improve the reliability and efficiency of integration.

To run this example from the MATLAB Help browser, click on the example name. Otherwise, type `vdpode` at the command line. At the command line, you can specify a value of μ as an argument to `vdpode`. The default is $\mu = 1000$.

```
function vdpode(MU)
%VDPODE Parameterizable van der Pol equation (stiff for large MU)
if nargin < 1
    MU = 1000;    % default
end

tspan = [0; max(20,3*MU)];           % Several periods
y0 = [2; 0];
options = odeset('Jacobian',@J);

[t,y] = ode15s(@f,tspan,y0,options,MU);

plot(t,y(:,1));
title(['Solution of van der Pol Equation, \mu = ' num2str(MU)]);
xlabel('time t');
ylabel('solution y_1');

axis([tspan(1) tspan(end) -2.5 2.5]);
-----
function dydt = f(t,y,mu)
dydt = [          y(2)
        mu*(1-y(1)^2)*y(2)-y(1) ];
-----
function dfdy = J(t,y,mu)
dfdy = [          0          1
        -2*mu*y(1)*y(2)-1    mu*(1-y(1)^2) ];
```

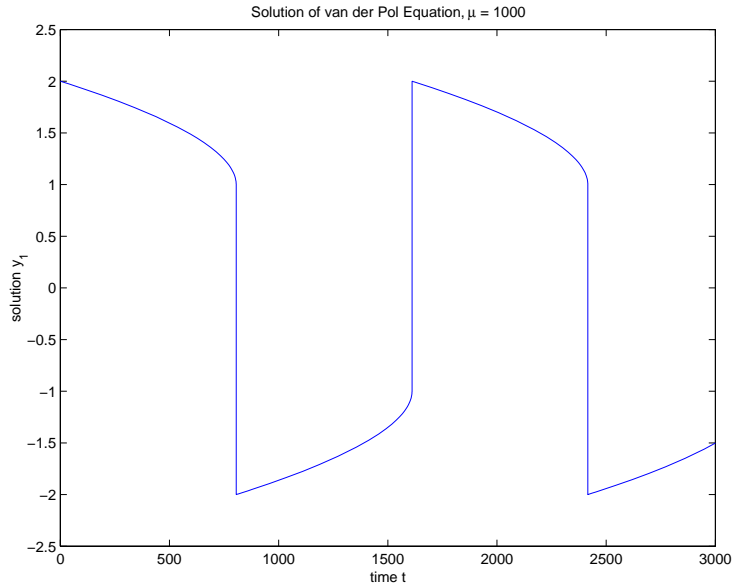

Example: Finite Element Discretization

`fem1ode` illustrates the solution of ODEs that result from a finite element discretization of a partial differential equation. The value of N in the call `fem1ode(N)` controls the discretization, and the resulting system consists of N equations. By default, N is 19.

This example involves a mass matrix. The system of ODEs comes from a method of lines solution of the partial differential equation

$$e^{-t} \frac{\partial u}{\partial t} = \frac{\partial^2 u}{\partial x^2}$$

with initial condition $u(0, x) = \sin(x)$ and boundary conditions $u(t, 0) = u(t, \pi) = 0$. An integer N is chosen, h is defined as $\pi/(N+1)$, and the solution of the partial differential equation is approximated at $x_k = kh$ for $k = 0, 1, \dots, N+1$ by

$$u(t, x_k) \approx \sum_{k=1}^N c_k(t) \phi_k(x)$$

Here $\phi_k(x)$ is a piecewise linear function that is 1 at x_k and 0 at all the other x_j . A Galerkin discretization leads to the system of ODEs

$$M(t)c' = Jc \text{ where } c(t) = \begin{bmatrix} c_1(t) \\ \vdots \\ c_N(t) \end{bmatrix}$$

and the tridiagonal matrices $M(t)$ and J are given by

$$M_{ij} = \begin{cases} 2h/3 \exp(-t) & \text{if } i = j \\ h/6 \exp(-t) & \text{if } i = j \pm 1 \\ 0 & \text{otherwise} \end{cases}$$

and

$$J_{ij} = \begin{cases} -2/h & \text{if } i = j \\ 1/h & \text{if } i = j \pm 1 \\ 0 & \text{otherwise} \end{cases}$$

The initial values $c(0)$ are taken from the initial condition for the partial differential equation. The problem is solved on the time interval $[0, \pi]$.

In `fem1ode` the properties

```
options = odeset('Mass', @mass, 'MStateDep', 'none', 'Jacobian', J)
```

indicate that the problem is of the form $M(t)y' = Jy$. The subfunction `mass(t, N)` evaluates the time-dependent mass matrix $M(t)$ and `J` is the constant Jacobian.

To run this example from the MATLAB Help browser, click on the example name. Otherwise, type `fem1ode` at the command line. At the command line, you can specify a value of N as an argument to `fem1ode`. The default is $N = 19$.

```
function fem1ode(N)
%FEM1ODE Stiff problem with a time-dependent mass matrix
```

```

if nargin < 1
    N = 19;
end
h = pi/(N+1);
y0 = sin(h*(1:N)');
tspan = [0; pi];

% The Jacobian is constant.
e = repmat(1/h,N,1);    % e=[(1/h) ... (1/h)];
d = repmat(-2/h,N,1);  % d=[(-2/h) ... (-2/h)];
J = spdiags([e d e], -1:1, N, N);

options = odeset('Mass',@mass,'MStateDependence','none', ...
                'Jacobian',J);

[t,y] = ode15s(@f,tspan,y0,options,N);

surf((1:N)/(N+1),t,y);
set(gca,'ZLim',[0 1]);
view(142.5,30);
title(['Finite element problem with time-dependent mass ' ...
      'matrix, solved by ODE15S']);
xlabel('space ( x/\pi )');
ylabel('time');
zlabel('solution');
%-----
function out = f(t,y,N)
h = pi/(N+1);
e = repmat(1/h,N,1);    % e=[(1/h) ... (1/h)];
d = repmat(-2/h,N,1);  % d=[(-2/h) ... (-2/h)];
J = spdiags([e d e], -1:1, N, N);
out = J*y;
%-----
function M = mass(t,N)
h = pi/(N+1);
e = repmat(exp(-t)*h/6,N,1); % e(i)=exp(-t)*h/6
e4 = repmat(4*exp(-t)*h/6,N,1);
M = spdiags([e e4 e], -1:1, N, N);

```

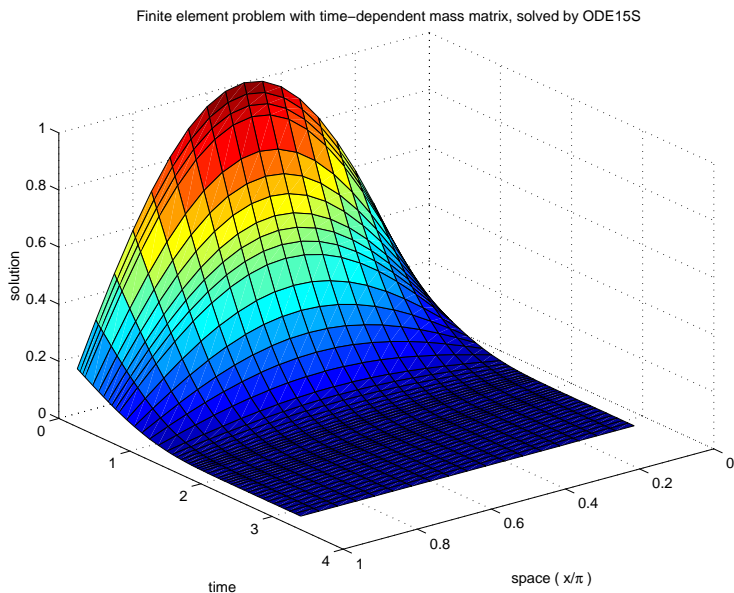

Example: Large, Stiff Sparse Problem

brussode illustrates the solution of a (potentially) large stiff sparse problem. The problem is the classic “Brusselator” system [3] that models diffusion in a chemical reaction

$$u'_i = 1 + u_i^2 v_i - 4u_i + \alpha(N+1)^2(u_{i-1} - 2u_i + u_{i+1})$$

$$v'_i = 3u_i - u_i^2 v_i + \alpha(N+1)^2(v_{i-1} - 2v_i + v_{i+1})$$

and is solved on the time interval $[0, 10]$ with $\alpha = 1/50$ and

$$\left. \begin{array}{l} u_i(0) = 1 + \sin(2\pi x_i) \\ v_i(0) = 3 \end{array} \right\} \text{ with } x_i = i/(N+1), \text{ for } i = 1, \dots, N$$

There are $2N$ equations in the system, but the Jacobian is banded with a constant width 5 if the equations are ordered as $u_1, v_1, u_2, v_2, \dots$

In the call `brussode(N)`, where N corresponds to N , the parameter $N \geq 2$ specifies the number of grid points. The resulting system consists of $2N$ equations. By default, N is 20. The problem becomes increasingly stiff and the Jacobian increasingly sparse as N increases.

The subfunction $f(t, y, N)$ returns the derivatives vector for the Brusselator problem. The subfunction `jpattern(N)` returns a sparse matrix of 1s and 0s showing the locations of nonzeros in the Jacobian $\partial f / \partial y$. The example assigns this matrix to the property `JPattern`, and the solver uses the sparsity pattern to generate the Jacobian numerically as a sparse matrix. Providing a sparsity pattern can significantly reduce the number of function evaluations required to generate the Jacobian and can accelerate integration. For the Brusselator problem, if the sparsity pattern is not supplied, $2N$ evaluations of the function are needed to compute the $2N$ -by- $2N$ Jacobian matrix. If the sparsity pattern is supplied, only four evaluations are needed, regardless of the value of N .

To run this example from the MATLAB Help browser, click on the example name. Otherwise, type `brussode` at the command line. At the command line, you can specify a value of N as an argument to `brussode`. The default is $N = 20$.

```
function brussode(N)
%BRUSSODE Stiff problem modeling a chemical reaction

if nargin<1
    N = 20;
end

tspan = [0; 10];
y0 = [1+sin((2*pi/(N+1))*(1:N)); repmat(3,1,N)];

options = odeset('Vectorized','on','JPattern',jpattern(N));

[t,y] = ode15s(@f,tspan,y0,options,N);

u = y(:,1:2:end);
x = (1:N)/(N+1);
surf(x,t,u);
view(-40,30);
xlabel('space');
ylabel('time');
```

```

zlabel('solution u');
title(['The Brusselator for N = ' num2str(N)]);
% -----
function dydt = f(t,y,N)
c = 0.02 * (N+1)^2;
dydt = zeros(2*N,size(y,2));      % preallocate dy/dt
% Evaluate the two components of the function at one edge of
% the grid (with edge conditions).
i = 1;
dydt(i,:) = 1 + y(i+1,:).*y(i,:).^2 - 4*y(i,:) + ...
            c*(1-2*y(i,:)+y(i+2,:));
dydt(i+1,:) = 3*y(i,:) - y(i+1,:).*y(i,:).^2 + ...
            c*(3-2*y(i+1,:)+y(i+3,:));
% Evaluate the two components of the function at all interior
% grid points.
i = 3:2:2*N-3;
dydt(i,:) = 1 + y(i+1,:).*y(i,:).^2 - 4*y(i,:) + ...
            c*(y(i-2,:)-2*y(i,:)+y(i+2,:));
dydt(i+1,:) = 3*y(i,:) - y(i+1,:).*y(i,:).^2 + ...
            c*(y(i-1,:)-2*y(i+1,:)+y(i+3,:));
% Evaluate the two components of the function at the other edge
% of the grid (with edge conditions).
i = 2*N-1;
dydt(i,:) = 1 + y(i+1,:).*y(i,:).^2 - 4*y(i,:) + ...
            c*(y(i-2,:)-2*y(i,:)+1);
dydt(i+1,:) = 3*y(i,:) - y(i+1,:).*y(i,:).^2 + ...
            c*(y(i-1,:)-2*y(i+1,:)+3);
% -----
function S = jpattern(N)
B = ones(2*N,5);
B(2:2:2*N,2) = zeros(N,1);
B(1:2:2*N-1,4) = zeros(N,1);
S = spdiags(B,-2:2,2*N,2*N);

```

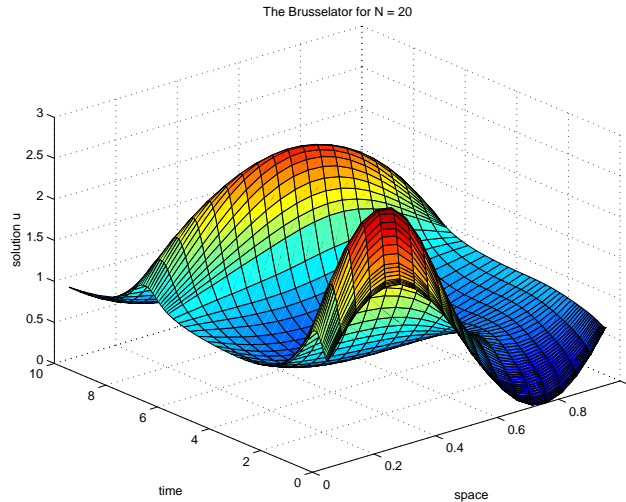
Example: Simple Event Location

ballode models the motion of a bouncing ball. This example illustrates the event location capabilities of the ODE solvers.

The equations for the bouncing ball are

$$\begin{aligned} y_1' &= y_2 \\ y_2' &= -9.8 \end{aligned}$$

In this example, the event function is coded in a subfunction events

```
[value, isterminal, direction] = events(t, y)
```

which returns:

- A value of the event function
- The information whether or not the integration should stop (`isterminal = 1` or 0, respectively) when `value = 0`
- The desired directionality of the zero crossings:

- 1 Detect zero crossings in the negative direction only
- 0 Detect all zero crossings
- 1 Detect zero crossings in the positive direction only

The length of `value`, `isterminal`, and `direction` is the same as the number of event functions. The *i*th element of each vector, corresponds to the *i*th event function. For an example of more advanced event location, see `orbitode` (“Example: Advanced Event Location” on page 15-44).

In `ballode`, setting the `Events` property to `@events` causes the solver to stop the integration (`isterminal = 1`) when the ball hits the ground (the height `y(1)` is 0) during its fall (`direction = -1`). The example then restarts the integration with initial conditions corresponding to a ball that bounced.

To run this example from the MATLAB Help browser, click on the example name. Otherwise, type `ballode` at the command line.

```
function ballode
%BALLODE Run a demo of a bouncing ball.

tstart = 0;
tfinal = 30;
y0 = [0; 20];
refine = 4;
options = odeset('Events',@events,'OutputFcn', @odeplot,...
                'OutputSel',1,'Refine',refine);

set(gca,'xlim',[0 30],'ylim',[0 25]);
box on
hold on;

tout = tstart;
yout = y0.';
teout = [];
yeout = [];
ieout = [];
for i = 1:10
    % Solve until the first terminal event.
    [t,y,te,ye,ie] = ode23(@f,[tstart tfinal],y0,options);
```

```

if ~ishold
    hold on
end
% Accumulate output.
nt = length(t);
tout = [tout; t(2:nt)];
yout = [yout; y(2:nt,:)];
teout = [teout; te]; % Events at tstart are never reported.
yeout = [yeout; ye];
ieout = [ieout; ie];

ud = get(gcf, 'UserData');
if ud.stop
    break;
end

% Set the new initial conditions, with .9 attenuation.
y0(1) = 0;
y0(2) = -.9*y(nt,2);

% A good guess of a valid first time step is the length of
% the last valid time step, so use it for faster computation.
options = odeset(options, 'InitialStep', t(nt)-t(nt-refine), ...
    'MaxStep', t(nt)-t(1));

tstart = t(nt);
end

plot(teout, yeout(:,1), 'ro')
xlabel('time');
ylabel('height');
title('Ball trajectory and the events');
hold off
odeplot([], [], 'done');
% -----
function dydt = f(t,y)
dydt = [y(2); -9.8];
% -----
function [value, isterminal, direction] = events(t,y)
% Locate the time when height passes through zero in a
% decreasing direction and stop integration.

```

```
value = y(1);    % Detect height = 0
isterminal = 1; % Stop the integration
direction = -1; % Negative direction only
```

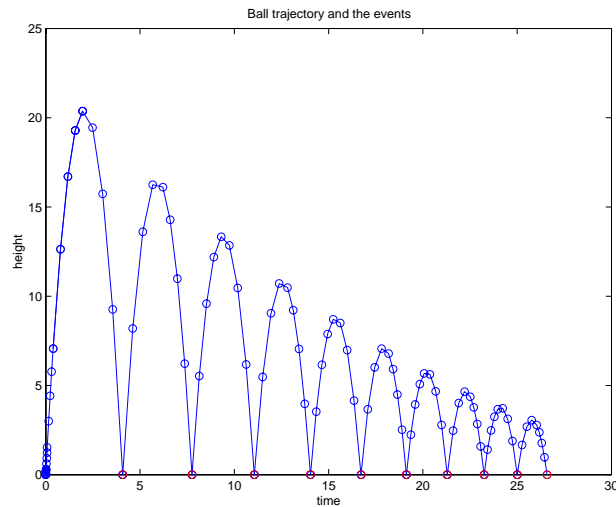

Example: Advanced Event Location

`orbitode` illustrates the solution of a standard test problem for those solvers that are intended for nonstiff problems. It traces the path of a spaceship traveling around the moon and returning to the earth. (Shampine and Gordon [7], p.246).

The `orbitode` problem is a system of the four equations shown below

$$y_1' = y_3$$

$$y_2' = y_4$$

$$y_3' = 2y_4 + y_1 - \frac{\mu^*(y_1 + \mu)}{r_1^3} - \frac{\mu(y_1 - \mu^*)}{r_2^3}$$

$$y_4' = -2y_3 + y_2 - \frac{\mu^*y_2}{r_1^3} - \frac{\mu y_2}{r_2^3}$$

where

$$\mu = 1/82.45$$

$$\mu^* = 1 - \mu$$

$$r_1 = \sqrt{(y_1 + \mu)^2 + y_2^2}$$

$$r_2 = \sqrt{(y_1 - \mu^*)^2 + y_2^2}$$

The first two solution components are coordinates of the body of infinitesimal mass, so plotting one against the other gives the orbit of the body. The initial conditions have been chosen to make the orbit periodic. The value of μ corresponds to a spaceship traveling around the moon and the earth. Moderately stringent tolerances are necessary to reproduce the qualitative behavior of the orbit. Suitable values are $1e-5$ for RelTol and $1e-4$ for AbsTol.

The events subfunction includes event functions which locate the point of maximum distance from the starting point and the time the spaceship returns to the starting point. Note that the events are located accurately, even though the step sizes used by the integrator are *not* determined by the location of the events. In this example, the ability to specify the direction of the zero crossing is critical. Both the point of return to the initial point and the point of maximum distance have the same event function value, and the direction of the crossing is used to distinguish them.

To run this example from the MATLAB Help browser, click on the example name. Otherwise, type `orbitode` at the command line. The example uses the

output function `odephase2` to produce the two-dimensional phase plane plot and let you to see the progress of the integration.

```
function orbitode
%ORBITODE Restricted three-body problem

tspan = [0 7];
y0 = [1.2; 0; 0; -1.04935750983031990726];
options = odeset('RelTol',1e-5,'AbsTol',1e-4,...
                'OutputFcn',@odephas2,'Events',@events);

[t,y,te,ye,ie] = ode45(@f,tspan,y0,options);

plot(y(:,1),y(:,2),ye(:,1),ye(:,2),'o');
title('Restricted three body problem')
ylabel('y(t)')
xlabel('x(t)')
% -----
function dydt = f(t,y)
mu = 1 / 82.45;
mustar = 1 - mu;
r13 = ((y(1) + mu)^2 + y(2)^2) ^ 1.5;
r23 = ((y(1) - mustar)^2 + y(2)^2) ^ 1.5;
dydt = [ y(3)
         y(4)
         2*y(4) + y(1) - mustar*((y(1)+mu)/r13) - ...
         mu*((y(1)-mustar)/r23)
         -2*y(3) + y(2) - mustar*(y(2)/r13) - mu*(y(2)/r23) ];
% -----
function [value,isterminal,direction] = events(t,y)
% Locate the time when the object returns closest to the
% initial point y0 and starts to move away, and stop integration.
% Also locate the time when the object is farthest from the
% initial point y0 and starts to move closer.
%
% The current distance of the body is
%
% DSQ = (y(1)-y0(1))^2 + (y(2)-y0(2))^2
%       = <y(1:2)-y0,y(1:2)-y0>
%
```

```

% A local minimum of DSQ occurs when d/dt DSQ crosses zero
% heading in the positive direction. We can compute d(DSQ)/dt as
%
%  $d(DSQ)/dt = 2*(y(1:2)-y0)'*dy(1:2)/dt = 2*(y(1:2)-y0)'*y(3:4)$ 
%
y0 = [1.2; 0];
dDSQdt = 2 * ((y(1:2)-y0)' * y(3:4));
value = [dDSQdt; dDSQdt];
isterminal = [1; 0];           % Stop at local minimum
direction = [1; -1];          % [local minimum, local maximum]

```

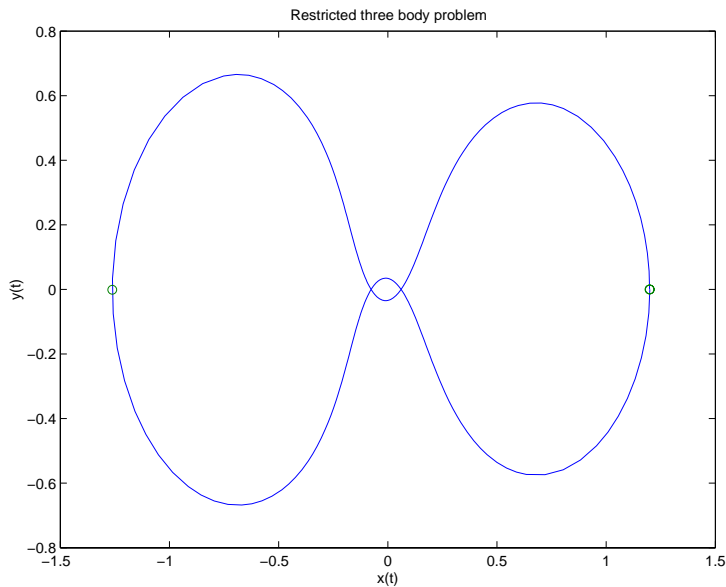

Example: Differential-Algebraic Problem

hb1dae reformulates the hb1ode example as a *differential-algebraic equation* (DAE) problem. The Robertson problem coded in hb1ode is a classic test problem for codes that solve stiff ODEs.

$$y_1' = -0.04y_1 + 10^4 y_2 y_3$$

$$y_2' = 0.04y_1 - 10^4 y_2 y_3 - 3 \cdot 10^7 y_2^2$$

$$y_3' = 3 \cdot 10^7 y_2^2$$

Note The Robertson problem appears as an example in the prolog to LSODI [4].

In `hb1ode`, the problem is solved with initial conditions $y_1(0) = 1$, $y_2(0) = 0$, $y_3(0) = 0$ to steady state. These differential equations satisfy a linear conservation law that is used to reformulate the problem as the DAE

$$y_1' = -0.04y_1 + 10^4 y_2 y_3$$

$$y_2' = 0.04y_1 - 10^4 y_2 y_3 - 3 \cdot 10^7 y_2^2$$

$$0 = y_1 + y_2 + y_3 - 1$$

Obviously these equations do not have a solution for $y(0)$ with components that do not sum to 1. The problem has the form of $My' = f(t, y)$ with

$$M = \begin{bmatrix} 1 & 0 & 0 \\ 0 & 1 & 0 \\ 0 & 0 & 0 \end{bmatrix}$$

M is obviously singular, but `hb1dae` does not inform the solver of this. The solver must recognize that the problem is a DAE, not an ODE. Similarly, although consistent initial conditions are obvious, the example uses an inconsistent value $y_3(0) = 10^{-3}$ to illustrate computation of consistent initial conditions.

To run this example from the MATLAB Help browser, click on the example name. Otherwise, type `hb1dae` at the command line. Note that `hb1dae`:

- Imposes a much smaller absolute error tolerance on y_2 than on the other components. This is because y_2 is much smaller than the other components and its major change takes place in a relatively short time.
- Specifies additional points at which the solution is computed to more clearly show the behavior of y_2 .
- Multiplies y_2 by 10^4 to make y_2 visible when plotting it with the rest of the solution.
- Uses a logarithmic scale to plot the solution on the long time interval.

```
function hb1dae
%HB1DAE Stiff differential-algebraic equation (DAE)

% A constant, singular mass matrix
M = [1 0 0
      0 1 0
      0 0 0];

% Use an inconsistent initial condition to test initialization.
y0 = [1; 0; 1e-3];
tspan = [0 4*logspace(-6,6)];

% Use the LSODI example tolerances. The 'MassSingular' property
% is left at its default 'maybe' to test the automatic detection
% of a DAE.
options = odeset('Mass',M,'RelTol',1e-4,...
                'AbsTol',[1e-6 1e-10 1e-6],'Vectorized','on');

[t,y] = ode15s(@f,tspan,y0,options);

y(:,2) = 1e4*y(:,2);

semilogx(t,y);
ylabel('1e4 * y(:,2)');
title(['Robertson DAE problem with a Conservation Law, '...
       'solved by ODE15S']);
xlabel('This is equivalent to the stiff ODEs coded in HB10DE.');
```

% -----

```
function out = f(t,y)
out = [ -0.04*y(1,:) + 1e4*y(2,:).*y(3,:)
        0.04*y(1,:) - 1e4*y(2,:).*y(3,:) - 3e7*y(2,:).^2
        y(1,:) + y(2,:) + y(3,:) - 1 ];
```

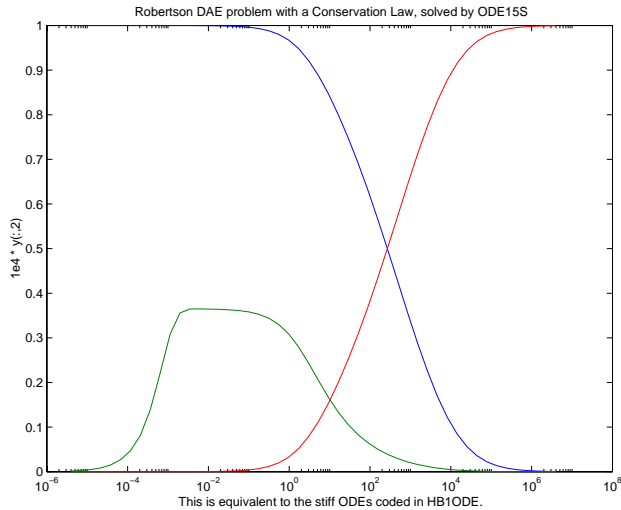

Questions and Answers, and Troubleshooting

This section contains a number of tables that answer questions about the use and operation of the MATLAB ODE solvers:

- General ODE solver questions
- Problem size, memory use, and computation speed
- Time steps for integration
- Error tolerance and other options
- Solving different kinds of problems
- Troubleshooting

General ODE Solver Questions

Question	Answer
How do the ODE solvers differ from quad or quad1?	quad and quad1 solve problems of the form $y' = f(t)$. The ODE solvers handle more general problems $y' = f(t, y)$, or problems that involve a mass matrix $M(t, y)y' = f(t, y)$.
Can I solve ODE systems in which there are more equations than unknowns, or vice versa?	No.

Problem Size, Memory Use, and Computation Speed

Question	Answer
How large a problem can I solve with the ODE suite?	<p>The primary constraints are memory and time. At each time step, the solvers for nonstiff problems allocate vectors of length n, where n is the number of equations in the system. The solvers for stiff problems allocate vectors of length n, but also an n-by-n Jacobian matrix. For these solvers it may be advantageous to use the sparse option.</p> <p>If the problem is nonstiff, or if you are using the sparse option, it may be possible to solve a problem with thousands of unknowns. In this case, however, storage of the result can be problematic. Try asking the solver to evaluate the solution at specific points only, or call the solver with no output arguments and use an output function to monitor the solution.</p>
I'm solving a very large system, but only care about a couple of the components of y . Is there any way to avoid storing all of the elements?	Yes. The user-installable output function capability is designed specifically for this purpose. When you call the solver with no output arguments, the solver does not allocate storage to hold the entire solution history. Instead, the solver calls <code>OutputFcn(t, y)</code> at each time step. To keep the history of specific elements, write an output function that stores or plots only the elements you care about.

Problem Size, Memory Use, and Computation Speed (Continued)

Question	Answer
What is the startup cost of the integration and how can I reduce it?	The biggest startup cost occurs as the solver attempts to find a step size appropriate to the scale of the problem. If you happen to know an appropriate step size, use the <code>InitialStep</code> property. For example, if you repeatedly call the integrator in an event location loop, the last step that was taken before the event is probably on scale for the next integration. See <code>ballode</code> for an example.

Time Steps for Integration

Question	Answer
The first step size that the integrator takes is too large, and it misses important behavior.	You can specify the first step size with the <code>InitialStep</code> property. The integrator tries this value, then reduces it if necessary.
Can I integrate with fixed step sizes?	No.

Error Tolerance and Other Options

Question	Answer
<p>How do I choose RelTol and AbsTol?</p>	<p>RelTol, the relative accuracy tolerance, controls the number of correct digits in the answer. AbsTol, the absolute error tolerance, controls the difference between the answer and the solution. At each step, the error e in component i of the solution satisfies</p> $ e(i) \leq \max(\text{RelTol} * \text{abs}(y(i)), \text{AbsTol}(i))$ <p>Roughly speaking, this means that you want RelTol correct digits in all solution components except those smaller than thresholds AbsTol(i). Even if you are not interested in a component $y(i)$ when it is small, you may have to specify AbsTol(i) small enough to get some correct digits in $y(i)$ so that you can accurately compute more interesting components.</p>
<p>I want answers that are correct to the precision of the computer. Why can't I simply set RelTol to eps?</p>	<p>You can get close to machine precision, but not that close. The solvers do not allow RelTol near eps because they try to approximate a continuous function. At tolerances comparable to eps, the machine arithmetic causes all functions to look discontinuous.</p>
<p>How do I tell the solver that I don't care about getting an accurate answer for one of the solution components?</p>	<p>You can increase the absolute error tolerance corresponding to this solution component. If the tolerance is bigger than the component, this specifies no correct digits for the component. The solver may have to get some correct digits in this component to compute other components accurately, but it generally handles this automatically.</p>

Solving Different Kinds of Problems

Question	Answer
<p>Can the solvers handle partial differential equations (PDEs) that have been discretized by the method of lines?</p>	<p>Yes, because the discretization produces a system of ODEs. Depending on the discretization, you might have a form involving mass matrices – MATLAB ODE solvers provide for this. Often the system is stiff. This is to be expected when the PDE is parabolic and when there are phenomena that happen on very different time scales such as a chemical reaction in a fluid flow. In such cases, use one of the four solvers: <code>ode15s</code>, <code>ode23s</code>, <code>ode23t</code>, <code>ode23tb</code>. If there are many equations, set the <code>JPattern</code> property. This might make the difference between success and failure due to the computation being too expensive. When the system is not stiff, or not very stiff, <code>ode23</code> or <code>ode45</code> is more efficient than <code>ode15s</code>, <code>ode23s</code>, <code>ode23t</code>, or <code>ode23tb</code>. For an example that uses <code>JPattern</code>, see “Example: Large, Stiff Sparse Problem” on page 15-38.</p> <p>Parabolic-elliptic partial differential equations in 1-D can be solved directly with the MATLAB PDE solver, <code>pdepe</code>. See “Partial Differential Equations” on page 15-82 for more information.</p>
<p>Can I solve differential-algebraic equation (DAE) systems?</p>	<p>Yes. The solvers <code>ode15s</code> and <code>ode23t</code> can solve some DAEs of the form $M(t, y)y' = f(t, y)$ where $M(t, y)$ is singular. The DAEs must be of index 1. For examples, see <code>amp1dae</code> or <code>hb1dae</code>.</p>
<p>Can I integrate a set of sampled data?</p>	<p>Not directly. You have to represent the data as a function by interpolation or some other scheme for fitting data. The smoothness of this function is critical. A piecewise polynomial fit like a spline can look smooth to the eye, but rough to a solver; the solver takes small steps where the derivatives of the fit have jumps. Either use a smooth function to represent the data or use one of the lower order solvers (<code>ode23</code>, <code>ode23s</code>, <code>ode23t</code>, <code>ode23tb</code>) that is less sensitive to this.</p>

Solving Different Kinds of Problems (Continued)

Question	Answer
Can I solve delay-differential equations?	Not directly. In some cases it is possible to use the initial value problem solvers to solve delay-differential equations by breaking the simulation interval into smaller intervals the length of a single delay. For more information about this approach, see [6].
What do I do when I have the final and not the initial value?	All the solvers of the MATLAB ODE suite allow you to solve backwards or forwards in time. The syntax for the solvers is <code>[t,y] = ode45(odefun,[t0 tf],y0);</code> and the syntax accepts <code>t0 > tf</code> .

Troubleshooting

Question	Answer
The solution doesn't look like what I expected.	If you're right about its appearance, you need to reduce the error tolerances from their default values. A smaller relative error tolerance is needed to compute accurately the solution of problems integrated over "long" intervals, as well as solutions of problems that are moderately unstable. You should check whether there are solution components that stay smaller than their absolute error tolerance for some time. If so, you are not asking for any correct digits in these components. This may be acceptable for these components, but failing to compute them accurately may degrade the accuracy of other components that depend on them.
My plots aren't smooth enough.	Increase the value of <code>Refine</code> from its default of 4 in <code>ode45</code> and 1 in the other solvers. The bigger the value of <code>Refine</code> , the more output points. Execution speed is not affected much by the value of <code>Refine</code> .

Troubleshooting (Continued)

Question	Answer
<p>I'm plotting the solution as it is computed and it looks fine, but the code gets stuck at some point.</p>	<p>First verify that the ODE function is smooth near the point where the code gets stuck. If it isn't, the solver must take small steps to deal with this. It may help to break <code>tspan</code> into pieces on which the ODE function is smooth.</p> <p>If the function is smooth and the code is taking extremely small steps, you are probably trying to solve a stiff problem with a solver not intended for this purpose. Switch to <code>ode15s</code>, <code>ode23s</code>, <code>ode23t</code>, or <code>ode23tb</code>.</p>
<p>My integration proceeds very slowly, using too many time steps.</p>	<p>First, check that your <code>tspan</code> is not too long. Remember that the solver uses as many time points as necessary to produce a smooth solution. If the ODE function changes on a time scale that is very short compared to the <code>tspan</code>, the solver uses a lot of time steps. Long-time integration is a hard problem. Break <code>tspan</code> into smaller pieces.</p> <p>If the ODE function does not change noticeably on the <code>tspan</code> interval, it could be that your problem is stiff. Try using <code>ode15s</code>, <code>ode23s</code>, <code>ode23t</code>, or <code>ode23tb</code>.</p> <p>Finally, make sure that the ODE function is written in an efficient way. The solvers evaluate the derivatives in the ODE function many times. The cost of numerical integration depends critically on the expense of evaluating the ODE function. Rather than recompute complicated constant parameters at each evaluation, store them in globals or calculate them once outside the function and pass them in as additional parameters.</p>
<p>I know that the solution undergoes a radical change at time t where</p> $t_0 \leq t \leq t_f$ <p>but the integrator steps past without "seeing" it.</p>	<p>If you know there is a sharp change at time t, it might help to break the <code>tspan</code> interval into two pieces, <code>[t0 t]</code> and <code>[t tf]</code>, and call the integrator twice.</p> <p>If the differential equation has periodic coefficients or solution, you might restrict the maximum step size to the length of the period so the integrator won't step over periods.</p>

Boundary Value Problems for ODEs

This section describes how to use MATLAB to solve boundary value problems (BVPs) of ordinary differential equations (ODEs). It provides:

- A summary of the MATLAB BVP functions and examples
- An introduction to BVPs
- A description of the BVP solver and its syntax
- General instructions for representing a BVP in MATLAB
- A discussion and examples about using continuation to solve a difficult problem
- A discussion about changing default integration properties to improve solver performance

BVP Function Summary

ODE Boundary Value Problem Solver

Solver	Description
bvp4c	Solve two-point boundary value problems for ordinary differential equations.

BVP Helper Functions

Function	Description
bvpinit	Form the initial guess for bvp4c.
deval	Evaluate the numerical solution using the output of bvp4c.

BVP Option Handling

An options structure contains named properties whose values are passed to the solver, and which affect problem solution. Use these functions to create, alter, or access an options structure.

Function	Description
bvpset	Create/alter the BVP options structure.
bvpget	Extract properties from options structure created with bvpset.

ODE Boundary Value Problem Examples

These examples illustrate the kind of problems you can solve using the MATLAB BVP solver. From the MATLAB Help browser, click the example name to see the code in an editor. Type the example name at the command line to run it.

Note The Differential Equations Examples browser enables you to view the code for the BVP examples, and also run them. Click on the link to invoke the browser, or type `odeexamples('bvp')` at the command line.

Example	Description
fsbvp	Falkner-Skan BVP on an infinite interval
mat4bvp	Fourth eigenfunction of Mathieu's equation
shockbvp	Solution with a shock layer near $x = 0$
twobvp	BVP with exactly two solutions

Additional examples are provided with the tutorial by Shampine, Reichelt, and Kierzenka, "Solving Boundary Value Problems for Ordinary Differential Equations in MATLAB with bvp4c." The tutorial and the examples are available at <ftp://ftp.mathworks.com/pub/doc/papers/bvp/>. This tutorial illustrates techniques for solving nontrivial real-life problems.

Introduction to Boundary Value ODE Problems

The BVP solver is designed to handle systems of ordinary differential equations

$$y' = f(x, y)$$

where x is the independent variable, y is the dependent variable, and y' represents dy/dx .

See “What Is an Ordinary Differential Equation” on page 15-6 for general information about ODEs.

Using Boundary Conditions to Specify the Solution of Interest

In a *boundary value problem*, the solution of interest satisfies certain boundary conditions. These conditions specify a relationship between the values of the solution at more than one x . `bvp4c` is designed to solve two-point BVPs, i.e., problems where the solution sought on an interval $[a, b]$ must satisfy the boundary conditions

$$g(y(a), y(b)) = 0$$

Unlike initial value problems, a boundary value problem may not have a solution, may have a finite number of solutions, or may have infinitely many solutions. As an integral part of the process of solving a BVP, you need to provide a guess for the required solution. The quality of this guess can be critical for the solver performance and even for a successful computation.

There may be other difficulties when solving BVPs, such as problems imposed on infinite intervals or problems that involve singular coefficients. Often BVPs involve unknown parameters p that have to be determined as part of solving the problem

$$y' = f(x, y, p)$$

$$g(y(a), y(b), p) = 0$$

In this case, the boundary conditions must suffice to determine the value of p .

Boundary Value Problem Solver

This section describes:

- The BVP solver, `bvp4c`
- BVP solver basic syntax
- Additional BVP solver arguments

You can also use the MATLAB Help browser to get information about the syntax for MATLAB functions.

The BVP Solver

The function `bvp4c` solves two-point boundary value problems for ordinary differential equations (ODEs). It integrates a system of first-order ordinary differential equations

$$y' = f(x, y)$$

on the interval $[a, b]$, subject to general two-point boundary conditions

$$bc(y(a), y(b)) = 0$$

It can also accommodate unknown parameters for problems of the form

$$\begin{aligned} y' &= f(x, y, p) \\ bc(y(a), y(b), p) &= 0 \end{aligned}$$

In this case, the number of boundary conditions must be sufficient to determine the solution and the unknown parameters. For more information, see “Finding Unknown Parameters” on page 15-67.

`bvp4c` produces a solution that is continuous on $[a, b]$ and has a continuous first derivative there. You can use the function `deval` and the output of `bvp4c` to evaluate the solution at specific points on the interval of integration.

`bvp4c` is a finite difference code that implements the 3-stage Lobatto IIIa formula. This is a collocation formula and the collocation polynomial provides a C^1 -continuous solution that is fourth-order accurate uniformly in the interval of integration. Mesh selection and error control are based on the residual of the continuous solution.

The collocation technique uses a mesh of points to divide the interval of integration into subintervals. The solver determines a numerical solution by

solving a global system of algebraic equations resulting from the boundary conditions, and the collocation conditions imposed on all the subintervals. The solver then estimates the error of the numerical solution on each subinterval. If the solution does not satisfy the tolerance criteria, the solver adapts the mesh and repeats the process. The user *must* provide the points of the initial mesh as well as an initial approximation of the solution at the mesh points.

BVP Solver Basic Syntax

The basic syntax of the BVP solver is

```
sol = bvp4c(odefun,bcfun,solinit)
```

The input arguments are:

odefun Function that evaluates the differential equations. It has the basic form

$$dydx = \text{odefun}(x,y)$$

where x is a scalar, and $dydx$ and y are column vectors. `odefun` can also accept a vector of unknown parameters and a variable number of known parameters.

bcfun Function that evaluates the residual in the boundary conditions. It has the basic form

$$\text{res} = \text{bcfun}(y_a, y_b)$$

where y_a and y_b are column vectors representing $y(a)$ and $y(b)$, and res is a column vector of the residual in satisfying the boundary conditions. `bcfun` can also accept a vector of unknown parameters and a variable number of known parameters.

solinit Structure with fields x and y :

x Ordered nodes of the initial mesh. Boundary conditions are imposed at $a = \text{solinit}.x(1)$ and $b = \text{solinit}.x(\text{end})$.

y Initial guess for the solution with $\text{solinit}.y(:,i)$ a guess for the solution at the node $\text{solinit}.x(i)$.

The structure can have any name, but the fields must be named x and y . It can also contain a vector that provides an initial guess for unknown parameters. You can form `solinit` with the helper function `bvpinit`. See the `bvpinit` reference page for details.

The output argument `sol` is a structure created by the solver. In the basic case the structure has fields x , y , and yp .

<code>sol.x</code>	Nodes of the mesh selected by <code>bvp4c</code>
<code>sol.y</code>	Approximation to $y(x)$ at the mesh points of <code>sol.x</code>
<code>sol.yp</code>	Approximation to $y'(x)$ at the mesh points of <code>sol.x</code>
<code>sol.parameters</code>	Value of unknown parameters, if present, found by the solver.
<code>sol.solver</code>	'bvp4c'

The function `deval` uses the output structure `sol` to evaluate the numerical solution at any point from $[a, b]$.

Additional BVP Solver Arguments

For more advanced applications, you can also specify as input arguments `solver` options and additional known parameters.

`options` Structure of optional parameters that change the default integration properties. This is the fourth input argument.

```
sol = bvp4c(odefun,bcfun,solinit,options)
```

“Creating and Maintaining a BVP Options Structure” on page 15-76 tells you how to create the structure and describes the properties you can specify.

p_1, p_2, \dots *Known* parameters that the solver passes to `odefun` and `bcfun`.

```
sol = bvp4c(odefun,bcfun,solinit,options,p1,p2,...)
```

The solver passes any input parameters that follow the `options` argument to `odefun` and `bcfun` every time it calls them. Use `options = []` as a placeholder if you set no options. In the `odefun` argument list, known parameters follow x , y , and a vector of unknown parameters (`parameters`), if present.

```
dydx = odefun(x,y,p1,p2,...)
dydx = odefun(x,y,parameters,p1,p2,...)
```

In the `bcfun` argument list, known parameters follow y_a , y_b , and a vector of unknown parameters, if present.

```
res = bcfun(ya,yb,p1,p2,...)
res = bcfun(ya,yb,parameters,p1,p2,...)
```

See “Example: Using Continuation to Solve a Difficult BVP” on page 15-68 for an example.

Representing BVP Problems

This section describes:

- The process for solving boundary value problems (BVPs) using the MATLAB solver, `bvp4c`
- Finding unknown parameters
- Evaluating the solution at specific points

Example: Mathieu’s Equation

This example determines the fourth eigenvalue of Mathieu’s Equation. It illustrates how to write second-order differential equations as a system of two first-order ODEs and how to use `bvp4c` to determine an unknown parameter λ .

The task is to compute the fourth ($q = 5$) eigenvalue λ of Mathieu’s equation

$$y'' + (\lambda - 2q \cos 2x)y = 0$$

Because the unknown parameter λ is present, this second-order differential equation is subject to *three* boundary conditions

$$y(0) = 1$$

$$y'(0) = 0$$

$$y'(\pi) = 0$$

Note The demo `mat4bvp` contains the complete code for this example. The demo uses subfunctions to place all functions required by `bvp4c` in a single M-file. To run this example type `mat4bvp` at the command line. See “BVP Solver Basic Syntax” on page 15-61 for more information.

1 Rewrite the Problem as a First-Order System. To use `bvp4c`, you must rewrite the equations as an equivalent system of first-order differential equations. Using a substitution $y_1 = y$ and $y_2 = y'$, the differential equation is written as a system of two first-order equations

$$y_1' = y_2$$

$$y_2' = -(\lambda - 2q \cos 2x)y_1$$

Note that the differential equations depend on the unknown parameter λ . The boundary conditions become

$$y_1(0) - 1 = 0$$

$$y_2(0) = 0$$

$$y_2(\pi) = 0$$

2 Code the System of First-Order ODEs in MATLAB. Once you represent the equation as a first-order system, you can code it as a function that `bvp4c` can use. Because there is an unknown parameter, the function must be of the form

$$dydx = \text{odefun}(x, y, \text{parameters})$$

The code below represents the system in the MATLAB function, `mat4ode`.

```
function dydx = mat4ode(x,y,lambda)
q = 5;
dydx = [ y(2)
         -(lambda - 2*q*cos(2*x))*y(1) ];
```

See “Finding Unknown Parameters” on page 15-67 for more information about using unknown parameters with `bvp4c`.

3 Code the Boundary Conditions Function. You must also code the boundary conditions in a MATLAB function. Because there is an unknown parameter, the function must be of the form

```
res = bcfun(ya,yb,parameters)
```

The code below represents the boundary conditions in the MATLAB function, `mat4bc`.

```
function res = mat4bc(ya,yb,lambda)
res = [ ya(2)
        yb(2)
        ya(1)-1 ];
```

4 Create an Initial Guess. To form the guess structure `solinit` with `bvpinit`, you need to provide initial guesses for both the solution and the unknown parameter.

The function `mat4init` provides an initial guess for the solution. `mat4init` uses $y = \cos 4x$ because this function satisfies the boundary conditions and has the correct qualitative behavior (the correct number of sign changes).

```
function yinit = mat4init(x)
yinit = [ cos(4*x)
          -4*sin(4*x) ];
```

In the call to `bvpinit`, the third argument, `lambda`, provides an initial guess for the unknown parameter λ .

```
lambda = 15;
solinit = bvpinit(linspace(0,pi,10),@mat4init,lambda);
```

This example uses `@` to pass `mat4init` as a function handle to `bvpinit`.

Note See the `function_handle (@)`, `func2str`, and `str2func` reference pages, and the “Function Handles” chapter of “Programming and Data Types” in the MATLAB documentation for information about function handles.

5 **Apply the BVP Solver.** The `mat4bvp` example calls `bvp4c` with the functions `mat4ode` and `mat4bc` and the structure `solinit` created with `bvpinit`.

```
sol = bvp4c(@mat4ode,@mat4bc,solinit);
```

6 **View the Results.** Complete the example by displaying the results:

- Print the value of the unknown parameter λ found by `bvp4c`.

```
fprintf('The fourth eigenvalue is approximately %7.3f.\n',...  
        sol.parameters)
```
- Use `deval` to evaluate the numerical solution at 100 equally spaced points in the interval $[0, \pi]$, and plot its first component. This component approximates $y(x)$.

```
xint = linspace(0,pi);  
Sxint = deval(sol,xint);  
plot(xint,Sxint(1,:))  
axis([0 pi -1 1.1])  
title('Eigenfunction of Mathieu''s equation.')  
xlabel('x')  
ylabel('solution y')
```

See “Evaluating the Solution at Specific Points” on page 15-68 for information about using `deval`.

The following plot shows the eigenfunction associated with the final eigenvalue $\lambda = 17.097$.

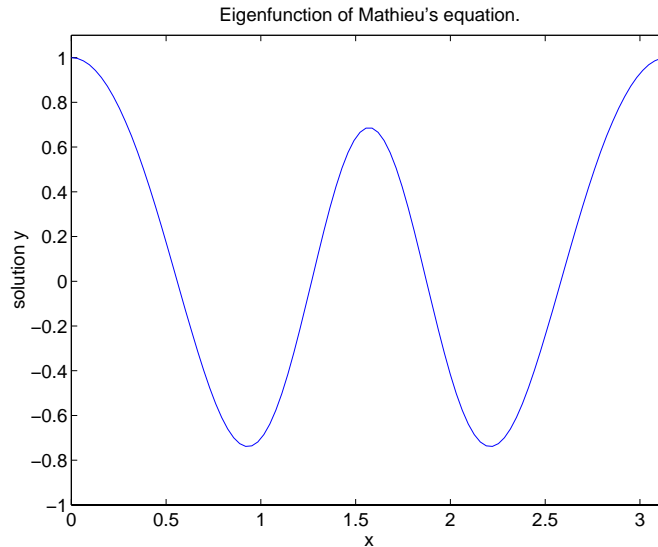

Finding Unknown Parameters

The `bvp4c` solver can find unknown parameters p for problems of the form

$$y' = f(x, y, p)$$

$$bc(y(a), y(b), p) = 0$$

You must provide `bvp4c` an initial guess for any unknown parameters in the vector `solinit.parameters`. When you call `bvpinit` to create the structure `solinit`, specify the initial guess as a vector in the additional argument `parameters`.

```
solinit = bvpinit(x,v,parameters)
```

The `bvp4c` function arguments `odefun` and `bcfun` must each have a third argument.

```
dydx = odefun(x,y,parameters)
res = bcfun(ya,yb,parameters)
```

The `bvp4c` solver calculates intermediate values of unknown parameters at each iteration, and passes the latest values to `odefun` and `bcfun` in the

parameters arguments. The solver returns the final values of these unknown parameters in `sol.parameters`. See “Example: Mathieu’s Equation” on page 15-63.

Evaluating the Solution at Specific Points

The collocation method implemented in `bvp4c` produces a C^1 -continuous solution over the whole interval of integration $[a, b]$. You can evaluate the approximate solution, $S(x)$, at any point in $[a, b]$ using the helper function `deval` and the structure `sol` returned by `bvp4c`.

```
Sxint = deval(sol,xint)
```

The `deval` function is vectorized. For a vector `xint`, the i th column of `Sxint` approximates the solution $y(xint(i))$.

Using Continuation to Make a Good Initial Guess

To solve a boundary value problem, you need to provide an initial guess for the solution. The quality of your initial guess can be critical to the solver performance, and to being able to solve the problem at all. However, coming up with a sufficiently good guess can be the most challenging part of solving a boundary value problem. Certainly, you should apply the knowledge of the problem’s physical origin. Often a problem can be solved as a sequence of relatively simpler problems, i.e., a continuation. This section provides examples that illustrate how to use continuation to:

- Solve a difficult BVP.
- Verify a solution’s consistent behavior.

Example: Using Continuation to Solve a Difficult BVP

This example solves the differential equation

$$\varepsilon y'' + xy' = \varepsilon \pi^2 \cos(\pi x) - \pi x \sin(\pi x)$$

for $\varepsilon = 10^{-4}$, on the interval $[-1, 1]$, with boundary conditions $y(-1) = -2$ and $y(1) = 0$. For $0 < \varepsilon < 1$, the solution has a transition layer at $x = 0$. Because of this rapid change in the solution for small values of ε , the problem becomes difficult to solve numerically.

The example solves the problem as a sequence of relatively simpler problems, i.e., a continuation. The solution of one problem is used as the initial guess for solving the next problem.

Note The demo `shockbvp` contains the complete code for this example. The demo uses subfunctions to place all required functions in a single M-file. To run this example type `shockbvp` at the command line. See “BVP Solver Basic Syntax” on page 15-61 and “Representing BVP Problems” on page 15-63 for more information.

Note This problem appears in [1] to illustrate the mesh selection capability of a well established BVP code COLSYS.

1 Code the ODE and Boundary Condition Functions. Code the differential equation and the boundary conditions as functions that `bvp4c` can use. Because there is an additional known parameter ε , the functions must be of the form

```
dydx = odefun(x,y,p1)
res = bcfun(ya,yb,p1)
```

The code below represents the differential equation and the boundary conditions in the MATLAB functions `shockODE` and `shockBC`. Note that `shockODE` is vectorized to improve solver performance. The additional parameter ε is represented by `e`.

```
function dydx = shockODE(x,y,e)
pix = pi*x;
dydx = [ y(2,:)
          -x/e.*y(2,:) - pi^2*cos(pix) - pix/e.*sin(pix) ];

function res = shockBC(ya,yb,e)
res = [ ya(1)+2
        yb(1)   ];
```

The example passes `e` as an additional input argument to `bvp4c`.

```
sol = bvp4c(@shockODE,@shockBC,sol,options,e);
```

bvp4c then passes this argument to the functions shockODE and shockBC when it evaluates them. See “Additional BVP Solver Arguments” on page 15-62 for more information.

2 Provide Analytical Partial Derivatives. For this problem, the solver benefits from using analytical partial derivatives. The code below represents the derivatives in functions shockJac and shockBCJac.

```
function jac = shockJac(x,y,e)
jac = [ 0 1
        0 -x/e ];

function [dBCdya,dBCdyb] = shockBCJac(ya,yb,e)
dBCdya = [ 1 0
            0 0 ];
dBCdyb = [ 0 0
            1 0 ];
```

shockJac and shockBCJac must accept the additional argument e, because bvp4c passes the additional argument to all the functions the user supplies.

Tell bvp4c to use these functions to evaluate the partial derivatives by setting the options FJacobian and BCJacobian. Also set 'Vectorized' to 'on' to indicate that the differential equation function shockODE is vectorized.

```
options = bvpset('FJacobian',@shockJac,...
                'BCJacobian',@shockBCJac,...
                'Vectorized','on');
```

3 Create an Initial Guess. You must provide bvp4c with a guess structure that contains an initial mesh and a guess for values of the solution at the mesh points. A constant guess of $y(x) \equiv 1$ and $y'(x) \equiv 0$, and a mesh of five equally spaced points on $[-1 1]$ suffice to solve the problem for $\varepsilon = 10^{-2}$. Use bvpinit to form the guess structure.

```
sol = bvpinit([-1 -0.5 0 0.5 1],[1 0]);
```

4 Use Continuation to Solve the Problem. To obtain the solution for the parameter $\varepsilon = 10^{-4}$, the example uses continuation by solving a sequence of problems for $\varepsilon = 10^{-2}, 10^{-3}, 10^{-4}$. The solver bvp4c does not perform continuation automatically, but the code's user interface has been designed to make

continuation easy. The code uses the output `sol` that `bvp4c` produces for one value of ϵ as the guess in the next iteration.

```
e = 0.1;
for i=2:4
    e = e/10;
    sol = bvp4c(@shockODE,@shockBC,sol,options,e);
end
```

5 View the Results. Complete the example by displaying the final solution

```
plot(sol.x,sol.y(1,:))
axis([-1 1 -2.2 2.2])
title(['There is a shock at x = 0 when \epsilon = '...
      sprintf('%e',e) '.'])
xlabel('x')
ylabel('solution y')
```

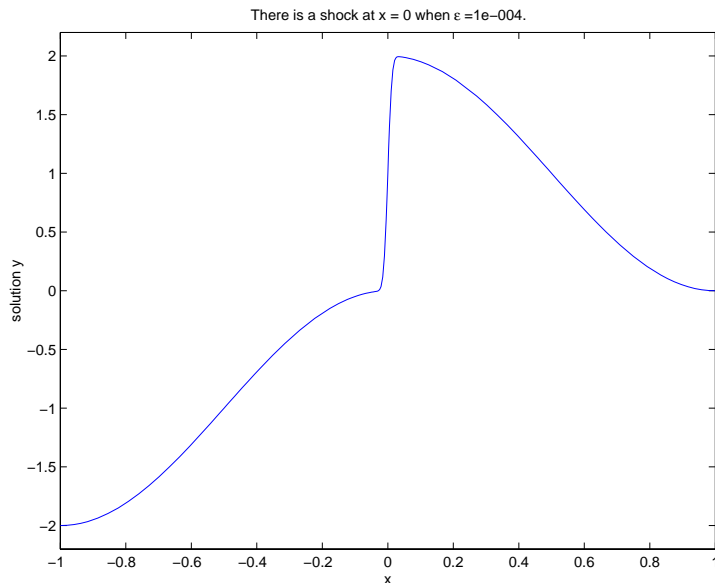

Example: Using Continuation to Verify a Solution's Consistent Behavior

Falkner-Skan BVPs arise from similarity solutions of viscous, incompressible, laminar flow over a flat plate. An example is

$$f''' + ff'' + \beta(1 - (f')^2) = 0$$

for $\beta = 0.5$ on the interval $[0, \infty)$ with boundary conditions $f(0) = 0$, $f'(0) = 0$, and $f'(\infty) = 1$.

The BVP cannot be solved on an infinite interval, and it would be impractical to solve it for even a very large finite interval. So, the example tries to solve a sequence of problems posed on increasingly larger intervals to verify the solution's consistent behavior as the boundary approaches ∞ .

The example imposes the infinite boundary condition at a finite point called `infinity`. The example then uses continuation in this end point to get convergence for increasingly larger values of `infinity`. It uses `bvpinit` to extrapolate the solution `sol` for one value of `infinity` as an initial guess for the new value of `infinity`. The plot of each successive solution is superimposed over those of previous solutions so they can easily be compared for consistency.

Note The demo `fsbvp` contains the complete code for this example. The demo uses subfunctions to place all required functions in a single M-file. To run this example type `fsbvp` at the command line. See “BVP Solver Basic Syntax” on page 15-61 and “Representing BVP Problems” on page 15-63 for more information.

1 Code the ODE and Boundary Condition Functions. Code the differential equation and the boundary conditions as functions that `bvp4c` can use.

```
function dfdeta = fsode(eta,f)
beta = 0.5;
dfdeta = [ f(2)
           f(3)
           -f(1)*f(3) - beta*(1 - f(2)^2) ];

function res = fsbc(f0,finf)
res = [f0(1)
       f0(2)]
```



```
f(2) - 1];
```

2 Create an Initial Guess. You must provide `bvp4c` with a guess structure that contains an initial mesh and a guess for values of the solution at the mesh points. A crude mesh of five points and a constant guess that satisfies the boundary conditions are good enough to get convergence when `infinity = 3`.

```
infinity = 3;
maxinfinity = 6;
```

```
solinit = bvpinit(linspace(0,infinity,5),[0 0 1]);
```

4 Solve on the Initial Interval. The example obtains the solution for `infinity = 3`. It then prints the computed value of $f'(0)$ for comparison with the value reported by Cebeci and Keller [2].

```
sol = bvp4c(@fsode,@fsbc,solinit);
eta = sol.x;
f = sol.y;
```

```
fprintf('\n');
fprintf('Cebeci & Keller report that f''(0) = 0.92768.\n');
fprintf('Value computed using infinity = %g is '...
        '%7.5f.\n',Bnew,f(3,1))
```

The example prints

```
Cebeci & Keller report that f''(0) = 0.92768.
Value computed using infinity = 3 is 0.92915.
```

5 Setup the Figure and Plot the Initial Solution.

```
figure
plot(eta,f(2,:),eta(end),f(2,end),'o');
axis([0 maxinfinity 0 1.4]);
title('Falkner-Skan equation, positive wall shear, \beta = 0.5.')
xlabel('\eta')
ylabel('df/d\eta')
hold on
drawnow
shg
```

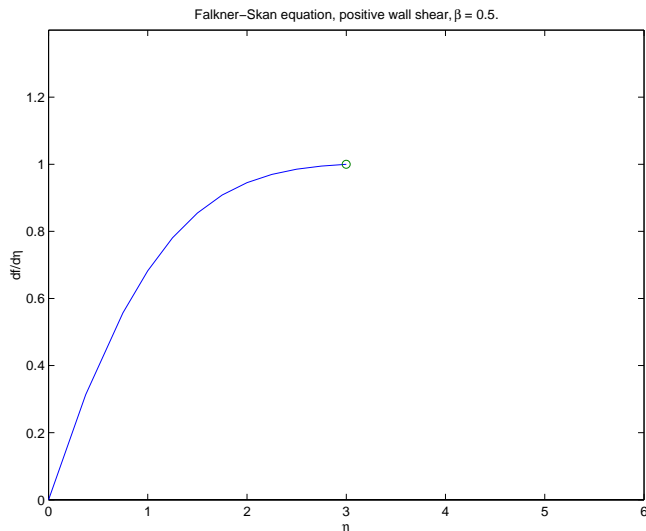

6 Use Continuation to Solve the Problem and Plot Subsequent Solutions. The example then solves the problem for $\infty = 4, 5, 6$. It uses `bvpinit` to extrapolate the solution `sol` for one value of ∞ as an initial guess for the next value of ∞ . For each iteration, the example prints the computed value of $f'(0)$ and superimposes a plot of the solution in the existing figure.

```
for Bnew = infinity+1:maxinfinity

    solinit = bvpinit(sol,[0 Bnew]); % Extend solution to Bnew.
    sol = bvp4c(@fsode,@fsbc,solinit);
    eta = sol.x;
    f = sol.y;

    fprintf('Value computed using infinity = %g is '...
           '%7.5f.\n',Bnew,f(3,1))
    plot(eta,f(2,:),eta(end),f(2,end),'o');
    drawnow

end
hold off
```

The example prints

```
Value computed using infinity = 4 is 0.92774.
Value computed using infinity = 5 is 0.92770.
Value computed using infinity = 6 is 0.92770.
```

Note that the values approach 0.92768 as reported by Cebeci and Keller. The superimposed plots confirm the consistency of the solution's behavior.

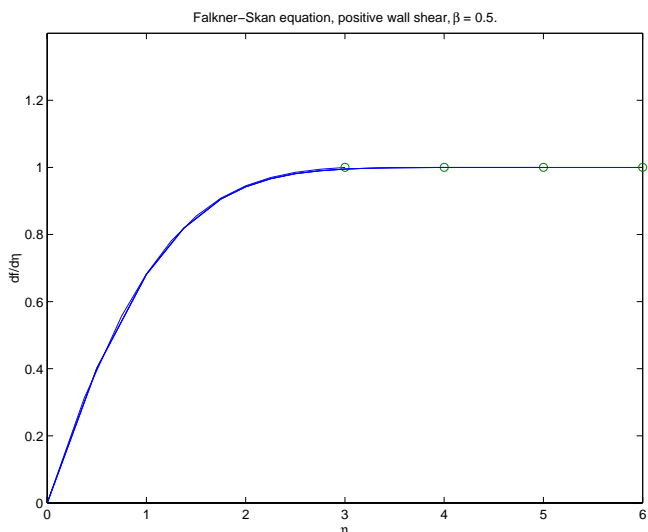

Improving BVP Solver Performance

The default integration properties in the BVP solver `bvp4c` are selected to handle common problems. In some cases, you can improve solver performance by changing these defaults. To do this, supply `bvp4c` with one or more property values in an options structure.

```
sol = bvp4c(odefun,bcfun,solinit,options)
```

This section:

- Explains how to create, modify, and query an options structure
- Describes the properties that you can use in an options structure

In this and subsequent property tables, the most commonly used property categories are listed first, followed by more advanced categories.

BVP Property Categories

Properties Category	Property Names
Error control	RelTol, AbsTol
Vectorization	Vectorized
Analytical partial derivatives	FJacobian, BCJacobian
Mesh size	NMax
Output displayed	Stats

Note For other ways to improve solver efficiency, check “Using Continuation to Make a Good Initial Guess” on page 8-68 and the tutorial, “Solving Boundary Value Problems for Ordinary Differential Equations in MATLAB with `bvp4c`,” available at <ftp://ftp.mathworks.com/pub/doc/papers/bvp/>.

Creating and Maintaining a BVP Options Structure

The `bvpset` function creates an options structure that you can supply to `bvp4c`. You can use `bvpget` to query the options structure for the value of a specific property.

Creating an Options Structure. The `bvpset` function accepts property name/property value pairs using the syntax

```
options = bvpset('name1',value1,'name2',value2,...)
```

This creates a structure `options` in which the named properties have the specified values. Unspecified properties retain their default values. For all properties, it is sufficient to type only the leading characters that uniquely identify the property name. `bvpset` ignores case for property names.

With no arguments, `bvpset` displays all property names and their possible values, indicating defaults with braces `{}`.

Modifying an Existing Options Structure. To modify an existing options argument, use

```
options = bvpset(olddopts, 'name1', value1, ...)
```

This overwrites any values in `olddopts` that are specified using name/value pairs. The modified structure is returned as the output argument. In the same way, the command

```
options = bvpset(olddopts, newopts)
```

combines the structures `olddopts` and `newopts`. In `options`, any values set in `newopts` overwrite those in `olddopts`.

Querying an Options Structure. The `bvpget` function extracts a property value from an options structure created with `bvpset`.

```
o = bvpget(options, 'name')
```

This returns the value of the specified property, or an empty matrix `[]` if the property value is unspecified in the options structure.

As with `bvpset`, it is sufficient to type only the leading characters that uniquely identify the property name; case is ignored for property names.

Error Tolerance Properties

Because `bvp4c` uses a collocation formula, the numerical solution is based on a mesh of points at which the collocation equations are satisfied. Mesh selection and error control are based on the residual of this solution, such that the computed solution $S(x)$ is the exact solution of a perturbed problem $S'(x) = f(x, S(x)) + res(x)$. On each subinterval of the mesh, a norm of the residual in the i th component of the solution, $res(i)$, is estimated and is required to be less than or equal to a tolerance. This tolerance is a function of the relative and absolute tolerances, `RelTol` and `AbsTol`, defined by the user.

$$\|(res(i)/\max(abs(f(i)), AbsTol(i))/RelTol)\| \leq RelTol$$

The following table describes the error tolerance properties. Use `bvpset` to set these properties.

BVP Error Tolerance Properties

Property	Value	Description
<code>RelTol</code>	Positive scalar {1e-3}	A relative error tolerance that applies to all components of the residual vector. It is a measure of the residual relative to the size of $f(x, y)$. The default, 1e-3, corresponds to 0.1% accuracy.
<code>AbsTol</code>	Positive scalar or vector {1e-6}	Absolute error tolerances that apply to the corresponding components of the residual vector. <code>AbsTol(i)</code> is a threshold below which the values of the corresponding components are unimportant. If a scalar value is specified, it applies to all components.

Vectorization

The following table describes the BVP vectorization property. Vectorization of the ODE function used by `bvp4c` differs from the vectorization used by the ODE solvers:

- For `bvp4c`, the ODE function must be vectorized with respect to the first argument as well as the second one, so that $F([x1 \ x2 \ \dots], [y1 \ y2 \ \dots])$ returns $[F(x1, y1) \ F(x2, y2) \ \dots]$.
- `bvp4c` benefits from vectorization even when analytical Jacobians are provided. For stiff ODE solvers, vectorization is ignored when analytical Jacobians are used.

Use `bvpset` to set this property.

Property	Value	Description
Vectorized	on {off}	<p>Set on to inform <code>bvp4c</code> that you have coded the ODE function <code>F</code> so that <code>F([x1 x2 ...],[y1 y2 ...])</code> returns <code>[F(x1,y1) F(x2,y2) ...]</code>. This allows the solver to reduce the number of function evaluations, and may significantly reduce solution time.</p> <p>With MATLAB's array notation, it is typically an easy matter to vectorize an ODE function. In the <code>shockbvp</code> example shown previously, the <code>shockODE</code> function has been vectorized using colon notation into the subscripts and by using the array multiplication (<code>.*</code>) operator.</p> <pre>function dydx = shockODE(x,y,e) pix = pi*x; dydx = [y(2,:) -x/e.*y(2,:)-pi^2*cos(pix)-pix/e.*sin(pix)];</pre>

Analytical Partial Derivatives

By default, the `bvp4c` solver approximates all partial derivatives with finite differences. `bvp4c` can be more efficient if you provide analytical partial derivatives $\partial f/\partial y$ of the differential equations, and analytical partial derivatives, $\partial bc/\partial y_a$ and $\partial bc/\partial y_b$, of the boundary conditions. If the problem involves unknown parameters, you must also provide partial derivatives, $\partial f/\partial p$ and $\partial bc/\partial p$, with respect to the parameters.

The following table describes the analytical partial derivatives properties. Use `bvpset` to set these properties.

BVP Analytical Partial Derivative Properties

Property	Value	Description
FJacobian	Function	The function computes the analytical partial derivatives of $f(x, y)$. When solving $y' = f(x, y)$, set this property to @fjac if $dfdy = fjac(x, y)$ evaluates the Jacobian $\partial f / \partial y$. If the problem involves unknown parameters p , $[dfdy, dfdp] = fjac(x, y, p)$ must also return the partial derivative $\partial f / \partial p$.
BCJacobian	Function	The function computes the analytical partial derivatives of $bc(ya, yb)$. For boundary conditions $bc(ya, yb)$, set this property to @bcjac if $[dbcnya, dbcnyb] = bcjac(ya, yb)$ evaluates the partial derivatives $\partial bc / \partial ya$, and $\partial bc / \partial yb$. If the problem involves unknown parameters p , $[dbcnya, dbcnyb, dbncp] = bcjac(ya, yb, p)$ must also return the partial derivative $\partial bc / \partial p$.

Mesh Size Property

bvp4c solves a system of algebraic equations to determine the numerical solution to a BVP at each of the mesh points. The size of the algebraic system depends on the number of differential equations (n) and the number of mesh points in the current mesh (N). When the allowed number of mesh points is exhausted, the computation stops, bvp4c displays a warning message and returns the solution it found so far. This solution does not satisfy the error tolerance, but it may provide an excellent initial guess for computations restarted with relaxed error tolerances or an increased value of NMax.

The following table describes the mesh size property. Use `bvpset` to set this property.

BVP Mesh Size Property

Property	Value	Description
NMax	positive integer { <code>floor(1000/n)</code> }	Maximum number of mesh points allowed when solving the BVP, where n is the number of differential equations in the problem. The default value of NMax limits the size of the algebraic system to about 1000 equations. For systems of a few differential equations, the default value of NMax should be sufficient to obtain an accurate solution.

Solution Statistic Property

The `Stats` property lets you view solution statistics.

The following table describes the solution statistics property. Use `bvpset` to set this property.

BVP Solution Statistic Property

Property	Value	Description
Stats	on {off}	Specifies whether statistics about the computations are displayed. If the <code>stats</code> property is on, after solving the problem, <code>bvp4c</code> displays: <ul style="list-style-type: none"> • The number of points in the mesh • The maximum residual of the solution • The number of times it called the differential equation function <code>odefun</code> to evaluate $f(x, y)$ • The number of times it called the boundary condition function <code>bcfun</code> to evaluate $bc(y(a), y(b))$

Partial Differential Equations

This section describes how to use MATLAB to solve initial-boundary value problems for partial differential equations (PDEs). It provides:

- A summary of the MATLAB PDE functions and examples
- An introduction to PDEs
- A description of the PDE solver and its syntax
- General instructions for representing a PDE in MATLAB, including an example
- A discussion about changing default integration properties to improve solver performance
- An example of solving a real-life problem

PDE Function Summary

MATLAB PDE Solver

This is the MATLAB PDE solver.

PDE Initial-Boundary Value Problem Solver

pdepe	Solve initial-boundary value problems for systems of parabolic and elliptic PDEs in one space variable and time.
-------	--

PDE Helper Function

PDE Helper Function

pdeval	Evaluate the numerical solution of a PDE using the output of pdepe.
--------	---

PDE Examples

These examples illustrate some problems you can solve using the MATLAB PDE solver. From the MATLAB Help browser, click the example name to see the code in an editor. Type the example name at the command line to run it.

Note The Differential Equations Examples browser enables you to view the code for the PDE examples, and also run them. Click on the link to invoke the browser, or type `odeexamples('pde')` at the command line.

Example	Description
pdex1	Simple PDE that illustrates the straightforward formulation, computation, and plotting of the solution
pdex2	Problem that involves discontinuities
pdex3	Problem that requires computing values of the partial derivative
pdex4	System of two PDEs whose solution has boundary layers at both ends of the interval and changes rapidly for small t
pdex5	System of PDEs with step functions as initial conditions

Introduction to PDE Problems

`pdepe` solves systems of PDEs in one spatial variable x and time t , of the form

$$c\left(x, t, u, \frac{\partial u}{\partial x}\right) \frac{\partial u}{\partial t} = x^{-m} \frac{\partial}{\partial x} \left(x^m f\left(x, t, u, \frac{\partial u}{\partial x}\right) \right) + s\left(x, t, u, \frac{\partial u}{\partial x}\right) \quad (15-3)$$

The PDEs hold for $t_0 \leq t \leq t_f$ and $a \leq x \leq b$. The interval $[a, b]$ must be finite. m can be 0, 1, or 2, corresponding to slab, cylindrical, or spherical symmetry, respectively. If $m > 0$, then $a \geq 0$ must also hold.

In Equation 15-3, $f(x, t, u, \partial u/\partial x)$ is a flux term and $s(x, t, u, \partial u/\partial x)$ is a source term. The coupling of the partial derivatives with respect to time is restricted to multiplication by a diagonal matrix $c(x, t, u, \partial u/\partial x)$. The diagonal elements of this matrix are either identically zero or positive. An element that is identically zero corresponds to an elliptic equation and otherwise to a parabolic equation. There must be at least one parabolic equation. An element of c that corresponds to a parabolic equation can vanish at isolated values of x

if they are mesh points. Discontinuities in c and/or s due to material interfaces are permitted provided that a mesh point is placed at each interface.

At the initial time $t = t_0$, for all x the solution components satisfy initial conditions of the form

$$u(x, t_0) = u_0(x) \quad (15-4)$$

At the boundary $x = a$ or $x = b$, for all t the solution components satisfy a boundary condition of the form

$$p(x, t, u) + q(x, t) f\left(x, t, u, \frac{\partial u}{\partial x}\right) = 0 \quad (15-5)$$

$q(x, t)$ is a diagonal matrix with elements that are either identically zero or never zero. Note that the boundary conditions are expressed in terms of the flux f rather than $\partial u / \partial x$. Also, of the two coefficients, only p can depend on u .

MATLAB Partial Differential Equation Solver

This section describes:

- The PDE solver, `pdepe`
- PDE solver basic syntax
- Additional PDE solver arguments

The PDE Solver

The MATLAB PDE solver, `pdepe`, solves initial-boundary value problems for systems of parabolic and elliptic PDEs in the one space variable x and time t . There must be at least one parabolic equation in the system.

The `pdepe` solver converts the PDEs to ODEs using a second-order accurate spatial discretization based on a set of nodes specified by the user. The discretization method is described in [8]. The time integration is done with `ode15s`. The `pdepe` solver exploits the capabilities of `ode15s` for solving the differential-algebraic equations that arise when Equation 15-3 contains elliptic equations, and for handling Jacobians with a specified sparsity pattern. `ode15s` changes both the time step and the formula dynamically.

After discretization, elliptic equations give rise to algebraic equations. If the elements of the initial conditions vector that correspond to elliptic equations

are not “consistent” with the discretization, `pdepe` tries to adjust them before beginning the time integration. For this reason, the solution returned for the initial time may have a discretization error comparable to that at any other time. If the mesh is sufficiently fine, `pdepe` can find consistent initial conditions close to the given ones. If `pdepe` displays a message that it has difficulty finding consistent initial conditions, try refining the mesh. No adjustment is necessary for elements of the initial conditions vector that correspond to parabolic equations.

PDE Solver Basic Syntax

The basic syntax of the solver is

```
sol = pdepe(m,pdefun,icfun,bcfun,xmesh,tspan)
```

Note Correspondences given are to terms used in “Introduction to PDE Problems” on page 15-83.

The input arguments are:

`m` Specifies the symmetry of the problem. `m` can be 0 = slab, 1 = cylindrical, or 2 = spherical. It corresponds to m in Equation 15-3.

`pdefun` Function that defines the components of the PDE. It computes the terms c , f , and s in Equation 15-3, and has the form

$$[c, f, s] = \text{pdefun}(x, t, u, \text{dudx})$$

where x and t are scalars, and u and dudx are vectors that approximate the solution u and its partial derivative with respect to x . c , f , and s are column vectors. c stores the diagonal elements of the matrix c .

`icfun` Function that evaluates the initial conditions. It has the form

$$u = \text{icfun}(x)$$

When called with an argument x , `icfun` evaluates and returns the initial values of the solution components at x in the column vector u .

`bcfun` Function that evaluates the terms p and q of the boundary conditions. It has the form

$$[p1, q1, pr, qr] = \text{bcfun}(x1, u1, xr, ur, t)$$

where $u1$ is the approximate solution at the left boundary $x1 = a$ and ur is the approximate solution at the right boundary $xr = b$. $p1$ and $q1$ are column vectors corresponding to p and the diagonal of q evaluated at $x1$. Similarly, pr and qr correspond to xr . When $m > 0$ and $a = 0$, boundedness of the solution near $x = 0$ requires that the flux f vanish at $a = 0$. `pdepe` imposes this boundary condition automatically and it ignores values returned in $p1$ and $q1$.

`xmesh` Vector $[x0, x1, \dots, xn]$ specifying the points at which a numerical solution is requested for every value in `tspan`. $x0$ and xn correspond to a and b , respectively.

Second-order approximation to the solution is made on the mesh specified in `xmesh`. Generally, it is best to use closely spaced mesh points where the solution changes rapidly. `pdepe` does *not* select the mesh in x automatically. You must provide an appropriate fixed mesh in `xmesh`. The cost depends strongly on the length of `xmesh`. When $m > 0$, it is not necessary to use a fine mesh near $x = 0$ to account for the coordinate singularity.

The elements of `xmesh` must satisfy $x0 < x1 < \dots < xn$. The length of `xmesh` must be ≥ 3 .

`tspan` Vector $[t0, t1, \dots, tf]$ specifying the points at which a solution is requested for every value in `xmesh`. $t0$ and tf correspond to t_0 and t_f , respectively.

`pdepe` performs the time integration with an ODE solver that selects both the time step and formula dynamically. The solutions at the points specified in `tspan` are obtained using the natural continuous extension of the integration formulas. The elements of `tspan` merely specify where you want answers and the cost depends weakly on the length of `tspan`.

The elements of `tspan` must satisfy $t0 < t1 < \dots < tf$. The length of `tspan` must be ≥ 3 .

The output argument `sol` is a three-dimensional array, such that:

- `sol(:, :, k)` approximates component k of the solution u .
- `sol(i, :, k)` approximates component k of the solution at time `tspan(i)` and mesh points `xmesh(:)`.
- `sol(i, j, k)` approximates component k of the solution at time `tspan(i)` and the mesh point `xmesh(j)`.

Additional PDE Solver Arguments

For more advanced applications, you can also specify as input arguments solver options and additional parameters that are passed to the PDE functions.

`options` Structure of optional parameters that change the default integration properties. This is the seventh input argument.

```
sol = pdepe(m,pdefun,icfun,bcfun,...
           xmesh,tspan,options)
```

See “Improving PDE Solver Performance” on page 15-93 for more information.

`p1,p2...` Parameters that the solver passes to `pdefun`, `icfun`, and `bcfun`.

```
sol = pdepe(m,pdefun,icfun,bcfun,xmesh,tspan,...
           options,p1,p2...)
```

The solver passes any input parameters that follow the `options` argument to `pdefun`, `icfun`, and `bcfun` every time it calls them. Use `options = []` as a placeholder if you set no options. In the `pdefun` argument list, parameters follow x , t , u , and $dudx$.

```
f = pdefun(x,t,u,dudx,p1,p2,...)
```

In the `icfun` argument list, parameters follow x .

```
res = icfun(x,p1,p2,...)
```

In the `bcfun` argument list, parameters follow x_l , u_l , x_r , u_r , and t .

```
res = bcfun(xl,ul,xr,ur,t,p1,p2,...)
```

See the `pdex3` demo for an example.

Representing PDE Problems

This section describes:

- The process for solving PDE problems using the MATLAB solver, `pdepe`
- Evaluating the solution at specific points

Example: A Single PDE

This example illustrates the straightforward formulation, solution, and plotting of the solution of a single PDE

$$\pi^2 \frac{\partial u}{\partial t} = \frac{\partial^2 u}{\partial x^2}$$

This equation holds on an interval $0 \leq x \leq 1$ for times $t \geq 0$. At $t = 0$, the solution satisfies the initial condition

$$u(x, 0) = \sin \pi x$$

At $x = 0$ and $x = 1$, the solution satisfies the boundary conditions

$$u(0, t) = 0$$

$$\pi e^{-t} + \frac{\partial u}{\partial x}(1, t) = 0$$

Note The demo `pdex1` contains the complete code for this example. The demo uses subfunctions to place all functions it requires in a single M-file. To run the demo type `pdex1` at the command line. See “PDE Solver Basic Syntax” on page 15-85 for more information.

1 Rewrite the PDE. Write the PDE in the form

$$c\left(x, t, u, \frac{\partial u}{\partial x}\right) \frac{\partial u}{\partial t} = x^{-m} \frac{\partial}{\partial x} \left(x^m f\left(x, t, u, \frac{\partial u}{\partial x}\right) \right) + s\left(x, t, u, \frac{\partial u}{\partial x}\right)$$

This is the form shown in Equation 15-3 and expected by `pdepe`. See “Introduction to PDE Problems” on page 15-83 for more information. For this example, the resulting equation is

$$\pi^2 \frac{\partial u}{\partial t} = x^0 \frac{\partial}{\partial x} \left(x^0 \frac{\partial u}{\partial x} \right) + 0$$

with parameter $m = 0$ and the terms

$$c\left(x, t, u, \frac{\partial u}{\partial x}\right) = \pi^2$$

$$f\left(x, t, u, \frac{\partial u}{\partial x}\right) = \frac{\partial u}{\partial x}$$

$$s\left(x, t, u, \frac{\partial u}{\partial x}\right) = 0$$

2 Code the PDE in MATLAB. Once you rewrite the PDE in the form shown above (Equation 15-3) and identify the terms, you can code the PDE in a function that `pdepe` can use. The function must be of the form

$$[c, f, s] = \text{pdefun}(x, t, u, \text{dudx})$$

where c , f , and s correspond to the c , f , and s terms. The code below computes c , f , and s for the example problem.

```
function [c,f,s] = pdex1pde(x,t,u,DuDx)
c = pi^2;
f = DuDx;
s = 0;
```

3 Code the Initial Conditions Function. You must code the initial conditions in a MATLAB function of the form

$$u = \text{icfun}(x)$$

The code below represents the initial conditions in the MATLAB function `pdex1ic`.

```
function u0 = pdex1ic(x)
u0 = sin(pi*x);
```

4 Code the Boundary Conditions Function. You must also code the boundary conditions in a MATLAB function of the form

$$[p_l, q_l, p_r, q_r] = \text{bcfun}(x_l, u_l, x_r, u_r, t)$$

The boundary conditions, written in the same form as Equation 15-5, are

$$u(0, t) + 0 \cdot \frac{\partial u}{\partial x}(0, t) = 0 \quad \text{at } x = 0$$

and

$$\pi e^{-t} + 1 \cdot \frac{\partial u}{\partial x}(1, t) = 0 \quad \text{at } x = 1$$

The code below evaluates the components $p(x, t, u)$ and $q(x, t)$ of the boundary conditions in the MATLAB function `pdex1bc`.

```
function [p1,q1,pr,qr] = pdex1bc(x1,u1,xr,ur,t)
p1 = u1;
q1 = 0;
pr = pi * exp(-t);
qr = 1;
```

In the function `pdex1bc`, `p1` and `q1` correspond to the left boundary conditions ($x = 0$), and `pr` and `qr` correspond to the right boundary condition ($x = 1$).

5 Select Mesh Points for the Solution. Before you use the MATLAB PDE solver, you need to specify the mesh points (t, x) at which you want `pdepe` to evaluate the solution. Specify the points as vectors `t` and `x`.

The vectors `t` and `x` play different roles in the solver (see “MATLAB Partial Differential Equation Solver” on page 15-84). In particular, the cost and the accuracy of the solution depend strongly on the length of the vector `x`. However, the computation is much less sensitive to the values in the vector `t`.

This example requests the solution on the mesh produced by 20 equally spaced points from the spatial interval $[0, 1]$ and five values of t from the time interval $[0, 2]$.

```
x = linspace(0,1,20);
t = linspace(0,2,5);
```

6 Apply the PDE Solver. The example calls `pdepe` with $m = 0$, the functions `pdex1pde`, `pdex1ic`, and `pdex1bc`, and the mesh defined by `x` and `t` at which `pdepe` is to evaluate the solution. The `pdepe` function returns the numerical solution in a three-dimensional array `sol`, where `sol(i, j, k)` approximates the k th component of the solution, u_k , evaluated at `t(i)` and `x(j)`.

```
m = 0;
sol = pdepe(m,@pdex1pde,@pdex1ic,@pdex1bc,x,t);
```

This example uses @ to pass pdex1pde, pdex1ic, and pdex1bc as function handles to pdepe.

Note See the `function_handle (@)`, `func2str`, and `str2func` reference pages, and the “Function Handles” chapter of “Programming and Data Types” in the MATLAB documentation for information about function handles.

7 View the Results. Complete the example by displaying the results:

- Extract and display the first solution component. In this example, the solution u has only one component, but for illustrative purposes, the example “extracts” it from the three-dimensional array. The surface plot shows the behavior of the solution.

```
u = sol(:,:,1);

surf(x,t,u)
title('Numerical solution computed with 20 mesh points')
xlabel('Distance x')
ylabel('Time t')
```

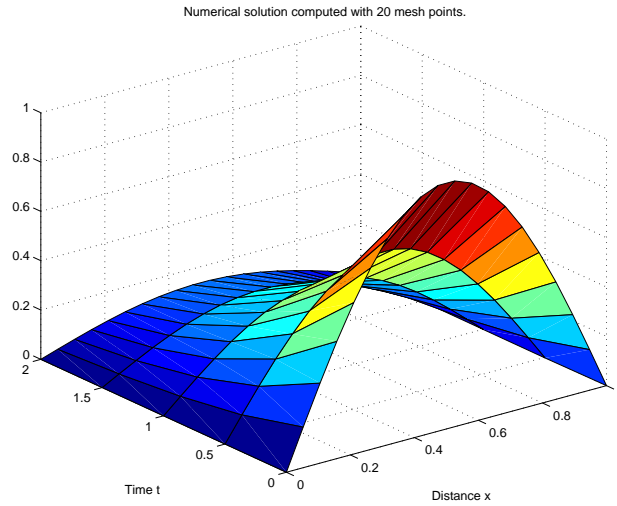

- Display a solution profile at t_f , the final value of t . In this example, $t_f = t = 2$. See “Evaluating the Solution at Specific Points” on page 15-93 for more information.

```
figure
plot(x,u(end,:))
title('Solution at t = 2')
xlabel('Distance x')
ylabel('u(x,2)')
```

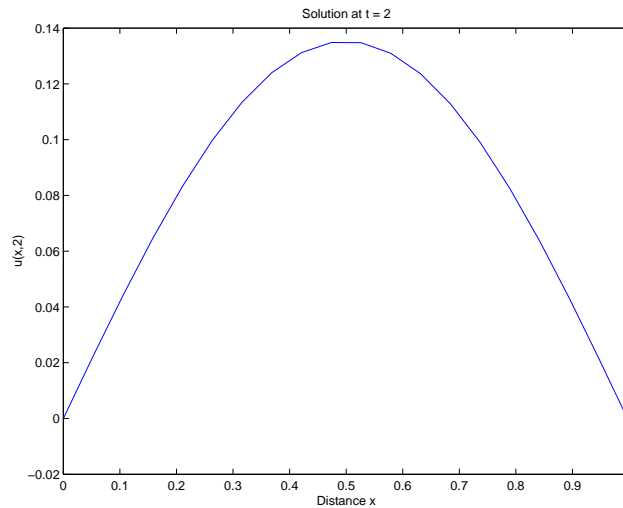

Evaluating the Solution at Specific Points

After obtaining and plotting the solution above, you might be interested in a solution profile for a particular value of t , or the time changes of the solution at a particular point x . The k th column $u(:,k)$ (of the solution extracted in step 7) contains the time history of the solution at $x(k)$. The j th row $u(j,:)$ contains the solution profile at $t(j)$.

Using the vectors x and $u(j,:)$, and the helper function `pdeval`, you can evaluate the solution u and its derivative $\partial u/\partial x$ at any set of points $xout$

```
[uout,DuoutDx] = pdeval(m,x,u(j,:),xout)
```

The example `pdex3` uses `pdeval` to evaluate the derivative of the solution at $xout = 0$. See `pdeval` for details.

Improving PDE Solver Performance

The default integration properties in the MATLAB PDE solver are selected to handle common problems. In some cases, you can improve solver performance by overriding these defaults. You do this by supplying `pdepe` with one or more property values in an options structure.

```
sol = pdepe(m,pdefun,icfun,bcfun,xmesh,tspan,options)
```

Use `odeset` to create the options structure. Only those options of the underlying ODE solver shown in the following table are available for `pdepe`. The defaults obtained by leaving off the input argument `options` are generally satisfactory. “Improving ODE Solver Performance” on page 15-16 tells you how to create the structure and describes the properties.

PDE Property Categories

Properties Category	Property Name
Error control	RelTol, AbsTol, NormControl
Step-size	InitialStep, MaxStep

Example: Electrodynamics Problem

This example illustrates the solution of a system of partial differential equations. The problem is taken from electrodynamics. It has boundary layers at both ends of the interval, and the solution changes rapidly for small t .

The PDEs are

$$\frac{\partial u_1}{\partial t} = 0.024 \frac{\partial^2 u_1}{\partial x^2} - F(u_1 - u_2)$$

$$\frac{\partial u_2}{\partial t} = 0.170 \frac{\partial^2 u_2}{\partial x^2} + F(u_1 - u_2)$$

where $F(y) = \exp(5.73y) - \exp(-11.46y)$. The equations hold on an interval $0 \leq x \leq 1$ for times $t \geq 0$.

The solution u satisfies the initial conditions

$$u_1(x, 0) \equiv 1$$

$$u_2(x, 0) \equiv 0$$

and boundary conditions

$$\frac{\partial u_1}{\partial x}(0, t) \equiv 0$$

$$u_2(0, t) \equiv 0$$

$$u_1(1, t) \equiv 1$$

$$\frac{\partial u_2}{\partial x}(1, t) \equiv 0$$

Note The demo `pdex4` contains the complete code for this example. The demo uses subfunctions to place all required functions in a single M-file. To run this example type `pdex4` at the command line. See “PDE Solver Basic Syntax” on page 15-85 and “Representing PDE Problems” on page 15-88 for more information.

1 Rewrite the PDE. In the form expected by `pdepe`, the equations are

$$\begin{bmatrix} 1 \\ 1 \end{bmatrix} .* \frac{\partial}{\partial t} \begin{bmatrix} u_1 \\ u_2 \end{bmatrix} = \frac{\partial}{\partial x} \begin{bmatrix} 0.024(\partial u_1 / \partial x) \\ 0.170(\partial u_2 / \partial x) \end{bmatrix} + \begin{bmatrix} -F(u_1 - u_2) \\ F(u_1 - u_2) \end{bmatrix}$$

The boundary conditions on the partial derivatives of u have to be written in terms of the flux. In the form expected by `pdepe`, the left boundary condition is

$$\begin{bmatrix} 0 \\ u_2 \end{bmatrix} + \begin{bmatrix} 1 \\ 0 \end{bmatrix} .* \begin{bmatrix} 0.024(\partial u_1 / \partial x) \\ 0.170(\partial u_2 / \partial x) \end{bmatrix} = \begin{bmatrix} 0 \\ 0 \end{bmatrix}$$

and the right boundary condition is

$$\begin{bmatrix} u_1 - 1 \\ 0 \end{bmatrix} + \begin{bmatrix} 0 \\ 1 \end{bmatrix} .* \begin{bmatrix} 0.024(\partial u_1 / \partial x) \\ 0.170(\partial u_2 / \partial x) \end{bmatrix} = \begin{bmatrix} 0 \\ 0 \end{bmatrix}$$

2 Code the PDE in MATLAB. After you rewrite the PDE in the form shown above, you can code it as a function that `pdepe` can use. The function must be of the form

$$[c, f, s] = \text{pdefun}(x, t, u, \text{dudx})$$

where c , f , and s correspond to the c , f , and s terms in Equation 15-3.

```
function [c,f,s] = pdex4pde(x,t,u,DuDx)
c = [1; 1];
f = [0.024; 0.17] .* DuDx;
y = u(1) - u(2);
F = exp(5.73*y) - exp(-11.47*y);
s = [-F; F];
```

3 Code the Initial Conditions Function. The initial conditions function must be of the form

```
u = icfun(x)
```

The code below represents the initial conditions in the MATLAB function `pdex4ic`.

```
function u0 = pdex4ic(x);
u0 = [1; 0];
```

4 Code the Boundary Conditions Function. The boundary conditions functions must be of the form

```
[p1,q1,pr,qr] = bcfun(x1,u1,xr,ur,t)
```

The code below evaluates the components $p(x, t, u)$ and $q(x, t)$ (Equation 15-5) of the boundary conditions in the MATLAB function `pdex4bc`.

```
function [p1,q1,pr,qr] = pdex4bc(x1,u1,xr,ur,t)
p1 = [0; u1(2)];
q1 = [1; 0];
pr = [ur(1)-1; 0];
qr = [0; 1];
```

5 Select Mesh Points for the Solution. The solution changes rapidly for small t . The program selects the step size in time to resolve this sharp change, but to see this behavior in the plots, output times must be selected accordingly. There are boundary layers in the solution at both ends of $[0,1]$, so mesh points must be placed there to resolve these sharp changes. Often some experimentation is needed to select the mesh that reveals the behavior of the solution.

```
x = [0 0.005 0.01 0.05 0.1 0.2 0.5 0.7 0.9 0.95 0.99 0.995 1];
t = [0 0.005 0.01 0.05 0.1 0.5 1 1.5 2];
```

6 Apply the PDE Solver. The example calls `pdepe` with $m = 0$, the functions `pdex4pde`, `pdex4ic`, and `pdex4bc`, and the mesh defined by x and t at which `pdepe` is to evaluate the solution. The `pdepe` function returns the numerical solution in a three-dimensional array `sol`, where `sol(i,j,k)` approximates the k th component of the solution, u_k , evaluated at $t(i)$ and $x(j)$.

```
m = 0;  
sol = pdepe(m,@pdex4pde,@pdex4ic,@pdex4bc,x,t);
```

7 View the Results. The surface plots show the behavior of the solution components.

```
u1 = sol(:,:,1);  
u2 = sol(:,:,2);  
  
figure  
surf(x,t,u1)  
title('u1(x,t)')  
xlabel('Distance x')  
ylabel('Time t')
```

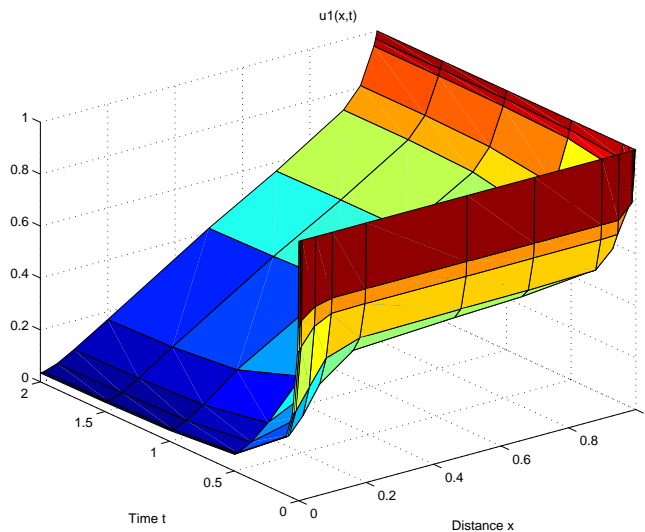

```
figure
surf(x,t,u2)
title('u2(x,t)')
xlabel('Distance x')
ylabel('Time t')
```

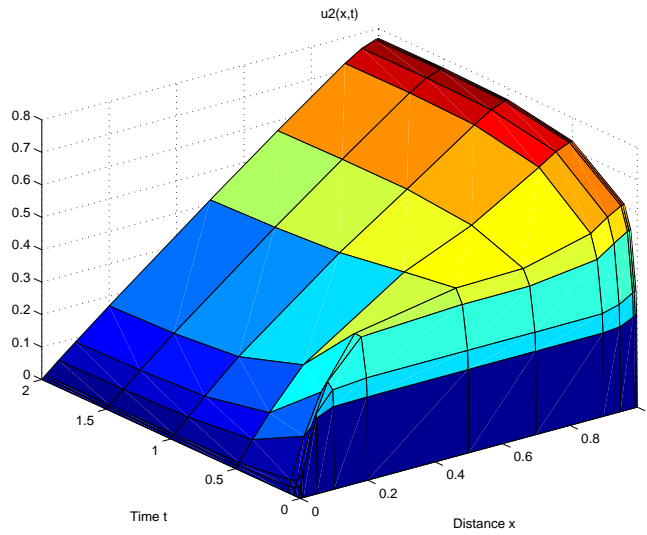

Selected Bibliography

- [1] Ascher, U., R. Mattheij, and R. Russell, *Numerical Solution of Boundary Value Problems for Ordinary Differential Equations*, SIAM, Philadelphia, PA, 1995, p. 372.
- [2] Cebeci, T. and H. B. Keller, "Shooting and Parallel Shooting Methods for Solving the Falkner-Skan Boundary-layer Equation," *J. Comp. Phys.*, Vol. 7, 1971, pp. 289-300.
- [3] Hairer, E., and G. Wanner, *Solving Ordinary Differential Equations II, Stiff and Differential-Algebraic Problems*, Springer-Verlag, Berlin, 1991, pp. 5-8.
- [4] Hindmarsh, A. C., "LSODE and LSODI, Two New Initial Value Ordinary Differential Equation Solvers," *SIGNUM Newsletter*, Vol. 15, 1980, pp. 10-11.
- [5] Hindmarsh, A. C., and G. D. Byrne, "Applications of EPISODE: An Experimental Package for the Integration of Ordinary Differential Equations," *Numerical Methods for Differential Systems*, L. Lapidus and W. E. Schiesser eds., Academic Press, Orlando, FL, 1976, pp 147-166.
- [6] Shampine, L. F., *Numerical Solution of Ordinary Differential Equations*, Chapman & Hall Mathematics, 1994.
- [7] Shampine, L. F., and M. K. Gordon, *Computer Solution of Ordinary Differential Equations*, W.H. Freeman & Co., 1975.
- [8] Skeel, R. D. and M. Berzins, "A Method for the Spatial Discretization of Parabolic Equations in One Space Variable," *SIAM Journal on Scientific and Statistical Computing*, Vol. 11, 1990, pp.1-32.

Sparse Matrices

Function Summary	16-3
Introduction	16-6
Sparse Matrix Storage	16-6
General Storage Information	16-7
Creating Sparse Matrices	16-7
Importing Sparse Matrices from Outside MATLAB	16-12
Viewing Sparse Matrices	16-13
Information About Nonzero Elements	16-13
Viewing Sparse Matrices Graphically	16-15
The find Function and Sparse Matrices	16-16
Example: Adjacency Matrices and Graphs	16-17
Introduction to Adjacency Matrices	16-17
Graphing Using Adjacency Matrices	16-18
The Bucky Ball	16-18
An Airflow Model	16-23
Sparse Matrix Operations	16-25
Computational Considerations	16-25
Standard Mathematical Operations	16-25
Permutation and Reordering	16-26
Factorization	16-30
Simultaneous Linear Equations	16-36
Eigenvalues and Singular Values	16-39
Selected Bibliography	16-42

MATLAB supports *sparse matrices*, matrices that contain a small proportion of nonzero elements. This characteristic provides advantages in both matrix storage space and computation time.

This chapter explains how to create sparse matrices in MATLAB, and how to use them in both specialized and general mathematical operations. It includes:

Function Summary

A summary of the sparse matrix functions

Introduction

An introduction to sparse matrices in MATLAB

Viewing Sparse Matrices

How to obtain quantitative and graphical information about sparse matrices

Example: Adjacency Matrices and Graphs

Examples that use adjacency matrices to demonstrate sparse matrices

Sparse Matrix Operations

A discussion of functions that perform operations specific to sparse matrices

Selected Bibliography

Published materials that support concepts described in this chapter

Function Summary

The sparse matrix functions are located in the `sparfun` directory in the MATLAB toolbox directory.

Function Summary

Category	Function	Description
Elementary sparse matrices	<code>speye</code>	Sparse identity matrix.
	<code>sprand</code>	Sparse uniformly distributed random matrix.
	<code>sprandn</code>	Sparse normally distributed random matrix.
	<code>sprandsym</code>	Sparse random symmetric matrix.
	<code>spdiags</code>	Sparse matrix formed from diagonals.
Full to sparse conversion	<code>sparse</code>	Create sparse matrix.
	<code>full</code>	Convert sparse matrix to full matrix.
	<code>find</code>	Find indices of nonzero elements.
	<code>spconvert</code>	Import from sparse matrix external format.
Working with sparse matrices	<code>nnz</code>	Number of nonzero matrix elements.
	<code>nonzeros</code>	Nonzero matrix elements.
	<code>nzmax</code>	Amount of storage allocated for nonzero matrix elements.
	<code>spones</code>	Replace nonzero sparse matrix elements with ones.
	<code>spalloc</code>	Allocate space for sparse matrix.
	<code>issparse</code>	True for sparse matrix.
	<code>spfun</code>	Apply function to nonzero matrix elements.
	<code>spy</code>	Visualize sparsity pattern.

Function Summary (Continued)

Category	Function	Description
Graph theory	gplot	Plot graph, as in “graph theory.”
	etree	Elimination tree.
	etreeplot	Plot elimination tree.
	treelayout	Lay out tree or forest.
	treeplot	Plot picture of tree.
Reordering algorithms	colamd	Column approximate minimum degree permutation.
	colmmd	Column minimum degree permutation.
	symamd	Symmetric approximate minimum degree permutation.
	symmmd	Symmetric minimum degree permutation.
	symrcm	Symmetric reverse Cuthill-McKee permutation.
	colperm	Column permutation.
	randperm	Random permutation.
	dmperm	Dulmage-Mendelsohn permutation.
Linear algebra	eigs	A few eigenvalues.
	svds	A few singular values.
	luinc	Incomplete LU factorization.
	cholinc	Incomplete Cholesky factorization.
	normest	Estimate the matrix 2-norm.
	condest	1-norm condition number estimate.
	sprank	Structural rank.

Function Summary (Continued)

Category	Function	Description
Linear equations (iterative methods)	bicg	BiConjugate Gradients Method.
	bicgstab	BiConjugate Gradients Stabilized Method.
	cgs	Conjugate Gradients Squared Method.
	gmres	Generalized Minimum Residual Method.
	lsqr	LSQR implementation of Conjugate Gradients on the Normal Equations.
	minres	Minimum Residual Method.
	pcg	Preconditioned Conjugate Gradients Method.
	qmr	Quasi-Minimal Residual Method.
	symmlq	Symmetric LQ method
Miscellaneous	spaument	Form least squares augmented system.
	spparms	Set parameters for sparse matrix routines.
	symbfact	Symbolic factorization analysis.

Introduction

Sparse matrices are a special class of matrices that contain a significant number of zero-valued elements. This property allows MATLAB to:

- Store only the nonzero elements of the matrix, together with their indices.
- Reduce computation time by eliminating operations on zero elements.

This section provides information about:

- Sparse matrix storage
- General storage information
- Creating sparse matrices
- Importing sparse matrices

Sparse Matrix Storage

For full matrices, MATLAB stores internally every matrix element. Zero-valued elements require the same amount of storage space as any other matrix element. For sparse matrices, however, MATLAB stores only the nonzero elements and their indices. For large matrices with a high percentage of zero-valued elements, this scheme significantly reduces the amount of memory required for data storage.

MATLAB uses three arrays internally to store sparse matrices with real elements. Consider an m -by- n sparse matrix with nnz nonzero entries stored in arrays of length $nzmax$:

- The first array contains all the nonzero elements of the array in floating-point format. The length of this array is equal to $nzmax$.
- The second array contains the corresponding integer row indices for the nonzero elements stored in the first nnz entries. This array also has length equal to $nzmax$.
- The third array contains n integer pointers to the start of each column in the other arrays and an additional pointer that marks the end of those arrays. The length of the third array is $n+1$.

This matrix requires storage for $nzmax$ floating-point numbers and $nzmax+n+1$ integers. At 8 bytes per floating-point number and 4 bytes per integer, the total number of bytes required to store a sparse matrix is

$$8 * nzmax + 4 * (nzmax + n + 1)$$

Sparse matrices with complex elements are also possible. In this case, MATLAB uses a fourth array with `nnz` elements to store the imaginary parts of the nonzero elements. An element is considered nonzero if either its real or imaginary part is nonzero.

General Storage Information

The `whos` command provides high-level information about matrix storage, including size and storage class. For example, this `whos` listing shows information about sparse and full versions of the same matrix.

```
whos
  Name           Size           Bytes  Class

  M_full        1100x1100       9680000  double array
  M_sparse      1100x1100         4404  sparse array
```

```
Grand total is 1210000 elements using 9684404 bytes
```

Notice that the number of bytes used is much less in the sparse case, because zero-valued elements are not stored. In this case, the density of the sparse matrix is $4404/9680000$, or approximately .00045%.

Creating Sparse Matrices

MATLAB never creates sparse matrices automatically. Instead, you must determine if a matrix contains a large enough percentage of zeros to benefit from sparse techniques.

The *density* of a matrix is the number of non-zero elements divided by the total number of matrix elements. Matrices with very low density are often good candidates for use of the sparse format.

Converting Full to Sparse

You can convert a full matrix to sparse storage using the `sparse` function with a single argument.

```
S = sparse(A)
```

For example

```
A = [ 0  0  0  5
      0  2  0  0
      1  3  0  0
      0  0  4  0];
```

```
S = sparse(A)
```

produces

```
S =
      (3,1)      1
      (2,2)      2
      (3,2)      3
      (4,3)      4
      (1,4)      5
```

The printed output lists the nonzero elements of S , together with their row and column indices. The elements are sorted by columns, reflecting the internal data structure.

You can convert a sparse matrix to full storage using the `full` function, provided the matrix order is not too large. For example `A = full(S)` reverses the example conversion.

Converting a full matrix to sparse storage is not the most frequent way of generating sparse matrices. If the order of a matrix is small enough that full storage is possible, then conversion to sparse storage rarely offers significant savings.

Creating Sparse Matrices Directly

You can create a sparse matrix from a list of nonzero elements using the `sparse` function with five arguments.

```
S = sparse(i, j, s, m, n)
```

i and j are vectors of row and column indices, respectively, for the nonzero elements of the matrix. s is a vector of nonzero values whose indices are specified by the corresponding (i, j) pairs. m is the row dimension for the resulting matrix, and n is the column dimension.

The matrix S of the previous example can be generated directly with

```
S = sparse([3 2 3 4 1],[1 2 2 3 4],[1 2 3 4 5],4,4)
```

```
S =
```

```
(3,1)      1
(2,2)      2
(3,2)      3
(4,3)      4
(1,4)      5
```

The `sparse` command has a number of alternate forms. The example above uses a form that sets the maximum number of nonzero elements in the matrix to `length(s)`. If desired, you can append a sixth argument that specifies a larger maximum, allowing you to add nonzero elements later without reallocating the sparse matrix.

Example: Generating a Second Difference Operator

The matrix representation of the second difference operator is a good example of a sparse matrix. It is a tridiagonal matrix with -2 s on the diagonal and 1 s on the super- and subdiagonal. There are many ways to generate it – here's one possibility.

```
D = sparse(1:n,1:n,-2*ones(1,n),n,n);
E = sparse(2:n,1:n-1,ones(1,n-1),n,n);
S = E+D+E'
```

For $n = 5$, MATLAB responds with

```
S =
```

```
(1,1)      -2
(2,1)       1
(1,2)       1
(2,2)      -2
(3,2)       1
(2,3)       1
(3,3)      -2
(4,3)       1
(3,4)       1
(4,4)      -2
```

```
(5,4)      1
(4,5)      1
(5,5)     -2
```

Now `F = full(S)` displays the corresponding full matrix.

```
F = full(S)
```

```
F =
```

```
-2    1    0    0    0
 1   -2    1    0    0
 0    1   -2    1    0
 0    0    1   -2    1
 0    0    0    1   -2
```

Creating Sparse Matrices from Their Diagonal Elements

Creating sparse matrices based on their diagonal elements is a common operation, so the function `spdiags` handles this task. Its syntax is

```
S = spdiags(B,d,m,n)
```

To create an output matrix S of size m -by- n with elements on p diagonals:

- B is a matrix of size $\min(m, n)$ -by- p . The columns of B are the values to populate the diagonals of S .
- d is a vector of length p whose integer elements specify which diagonals of S to populate.

That is, the elements in column j of B fill the diagonal specified by element j of d .

Note If a column of B is longer than the diagonal it's replacing, super-diagonals are taken from the lower part of the column of B , and sub-diagonals are taken from the upper part of the column of B .

As an example, consider the matrix B and the vector d.

```
B = [ 41    11    0
      52    22    0
      63    33   13
      74    44   24 ];
```

```
d = [-3
      0
      2];
```

Use these matrices to create a 7-by-4 sparse matrix A.

```
A = spdiags(B,d,7,4)
```

```
A =
```

```
(1,1)    11
(4,1)    41
(2,2)    22
(5,2)    52
(1,3)    13
(3,3)    33
(6,3)    63
(2,4)    24
(4,4)    44
(7,4)    74
```

In its full form, A looks like this.

```
full(A)
```

```
ans =
```

```
11    0   13    0
 0   22    0   24
 0    0   33    0
41    0    0   44
 0   52    0    0
 0    0   63    0
 0    0    0   74
```

`spdiags` can also extract diagonal elements from a sparse matrix, or replace matrix diagonal elements with new values. Type `help spdiags` for details.

Importing Sparse Matrices from Outside MATLAB

You can import sparse matrices from computations outside MATLAB. Use the `spconvert` function in conjunction with the `load` command to import text files containing lists of indices and nonzero elements. For example, consider a three-column text file `T.dat` whose first column is a list of row indices, second column is a list of column indices, and third column is a list of nonzero values. These statements load `T.dat` into MATLAB and convert it into a sparse matrix `S`:

```
load T.dat
S = spconvert(T)
```

The `save` and `load` commands can also process sparse matrices stored as binary data in MAT-files.

Viewing Sparse Matrices

MATLAB provides a number of functions that let you get quantitative or graphical information about sparse matrices.

This section provides information about:

- Obtaining information about nonzero elements
- Viewing graphs of sparse matrices
- Finding indices and values of nonzero elements

Information About Nonzero Elements

There are several commands that provide high-level information about the nonzero elements of a sparse matrix:

- `nnz` returns the number of nonzero elements in a sparse matrix.
- `nonzeros` returns a column vector containing all the nonzero elements of a sparse matrix.
- `nzmax` returns the amount of storage space allocated for the nonzero entries of a sparse matrix.

To try some of these, load the supplied sparse matrix `west0479`, one of the Harwell-Boeing collection.

```
load west0479
whos
  Name           Size           Bytes   Class
  west0479      479x479           24576   sparse array
```

This matrix models an eight-stage chemical distillation column.

Try these commands.

```
nnz(west0479)

ans =

      1887

format short e
```

```
west0479

west0479 =

(25,1)      1.0000e+00
(31,1)     -3.7648e-02
(87,1)     -3.4424e-01
(26,2)      1.0000e+00
(31,2)     -2.4523e-02
(88,2)     -3.7371e-01
(27,3)      1.0000e+00
(31,3)     -3.6613e-02
(89,3)     -8.3694e-01
(28,4)      1.3000e+02
.
.
.
```

```
nonzeros(west0479);
ans =

1.0000e+00
-3.7648e-02
-3.4424e-01
1.0000e+00
-2.4523e-02
-3.7371e-01
1.0000e+00
-3.6613e-02
-8.3694e-01
1.3000e+02
.
.
.
```

Note Use **Ctrl+C** to stop the nonzeros listing at any time.

Note that initially `nnz` has the same value as `nzmax` by default. That is, the number of nonzero elements is equivalent to the number of storage locations allocated for nonzeros. However, MATLAB does not dynamically release memory if you zero out additional array elements. Changing the value of some matrix elements to zero changes the value of `nnz`, but not that of `nzmax`.

However, you can add as many nonzero elements to the matrix as desired. You are not constrained by the original value of `nzmax`.

Viewing Sparse Matrices Graphically

It is often useful to use a graphical format to view the distribution of the nonzero elements within a sparse matrix. MATLAB's `spy` function produces a template view of the sparsity structure, where each point on the graph represents the location of a nonzero array element.

For example,

```
spy(west0479)
```

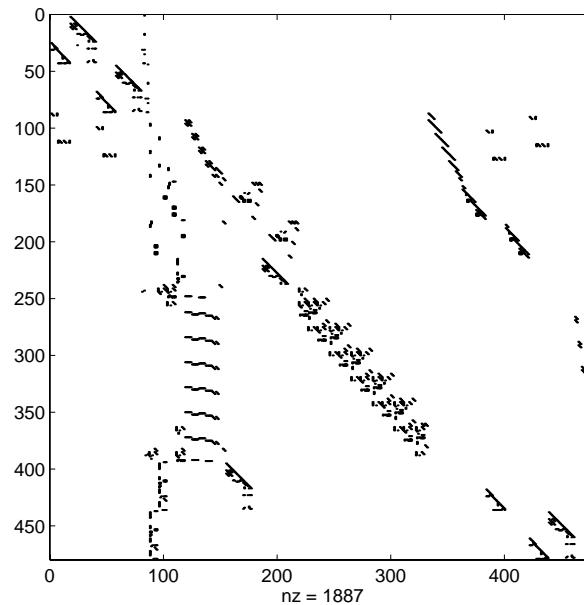

The find Function and Sparse Matrices

For any matrix, full or sparse, the `find` function returns the indices and values of nonzero elements. Its syntax is

```
[i,j,s] = find(S)
```

`find` returns the row indices of nonzero values in vector `i`, the column indices in vector `j`, and the nonzero values themselves in the vector `s`. The example below uses `find` to locate the indices and values of the nonzeros in a sparse matrix. The `sparse` function uses the `find` output, together with the size of the matrix, to recreate the matrix.

```
[i,j,s] = find(S)
[m,n] = size(S)
S = sparse(i,j,s,m,n)
```

Example: Adjacency Matrices and Graphs

This section includes:

- An introduction to adjacency matrices
- Instructions for graphing adjacency matrices with `gplot`
- A Bucky ball example, including information about using `spy` plots to illustrate fill-in and distance
- An airflow model example

Introduction to Adjacency Matrices

The formal mathematical definition of a *graph* is a set of points, or nodes, with specified connections between them. An economic model, for example, is a graph with different industries as the nodes and direct economic ties as the connections. The computer software industry is connected to the computer hardware industry, which, in turn, is connected to the semiconductor industry, and so on.

This definition of a graph lends itself to matrix representation. The *adjacency matrix* of an *undirected* graph is a matrix whose (i, j) th and (j, i) th entries are 1 if node i is connected to node j , and 0 otherwise. For example, the adjacency matrix for a diamond-shaped graph looks like

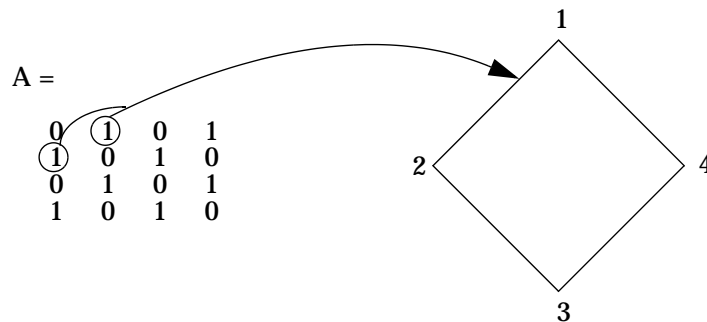

Since most graphs have relatively few connections per node, most adjacency matrices are sparse. The actual locations of the nonzero elements depend on how the nodes are numbered. A change in the numbering leads to permutation

of the rows and columns of the adjacency matrix, which can have a significant effect on both the time and storage requirements for sparse matrix computations.

Graphing Using Adjacency Matrices

MATLAB's `gplot` function creates a graph based on an adjacency matrix and a related array of coordinates. To try `gplot`, create the adjacency matrix shown above by entering

```
A = [0 1 0 1; 1 0 1 0; 0 1 0 1; 1 0 1 0];
```

The columns of `gplot`'s coordinate array contain the Cartesian coordinates for the corresponding node. For the diamond example, create the array by entering

```
xy = [1 3; 2 1; 3 3; 2 5];
```

This places the first node at location (1,3), the second at location (2,1), the third at location (3,3), and the fourth at location (2,5). To view the resulting graph, enter

```
gplot(A,xy)
```

The Bucky Ball

One interesting construction for graph analysis is the *Bucky ball*. This is composed of 60 points distributed on the surface of a sphere in such a way that the distance from any point to its nearest neighbors is the same for all the points. Each point has exactly three neighbors. The Bucky ball models four different physical objects:

- The geodesic dome popularized by Buckminster Fuller
- The C_{60} molecule, a form of pure carbon with 60 atoms in a nearly spherical configuration
- In geometry, the truncated icosahedron
- In sports, the seams in a soccer ball

The Bucky ball adjacency matrix is a 60-by-60 symmetric matrix B . B has three nonzero elements in each row and column, for a total of 180 nonzero values. This matrix has important applications related to the physical objects listed earlier. For example, the eigenvalues of B are involved in studying the chemical properties of C_{60} .

To obtain the Bucky ball adjacency matrix, enter

```
B = bucky;
```

At order 60, and with a density of 5%, this matrix does not require sparse techniques, but it does provide an interesting example.

You can also obtain the coordinates of the Bucky ball graph using

```
[B,v] = bucky;
```

This statement generates `v`, a list of *xyz*-coordinates of the 60 points in 3-space equidistributed on the unit sphere. The function `gplot` uses these points to plot the Bucky ball graph.

```
gplot(B,v)  
axis equal
```

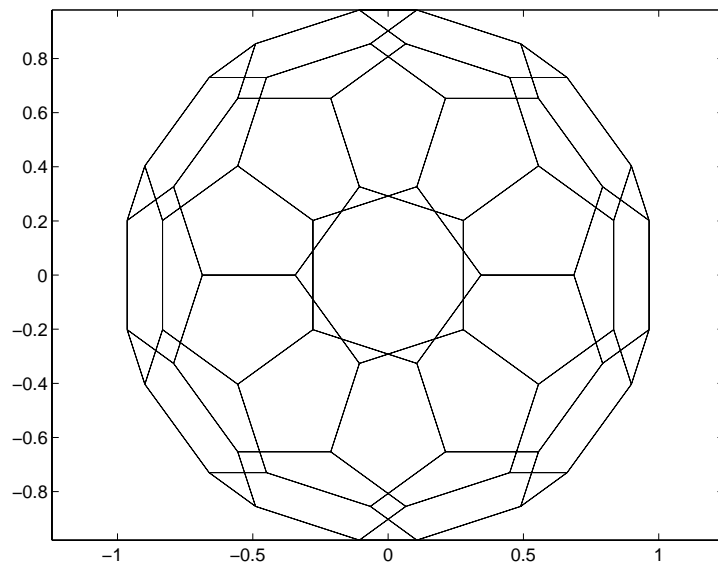

It is not obvious how to number the nodes in the Bucky ball so that the resulting adjacency matrix reflects the spherical and combinatorial symmetries of the graph. The numbering used by `bucky.m` is based on the pentagons inherent in the ball's structure.

The vertices of one pentagon are numbered 1 through 5, the vertices of an adjacent pentagon are numbered 6 through 10, and so on. The picture on the following page shows the numbering of half of the nodes (one hemisphere); the numbering of the other hemisphere is obtained by a reflection about the equator. Use `gplot` to produce a graph showing half the nodes. You can add the node numbers using a `for` loop.

```
k = 1:30;
gplot(B(k,k),v);
axis square
for j = 1:30, text(v(j,1),v(j,2), int2str(j)); end
```

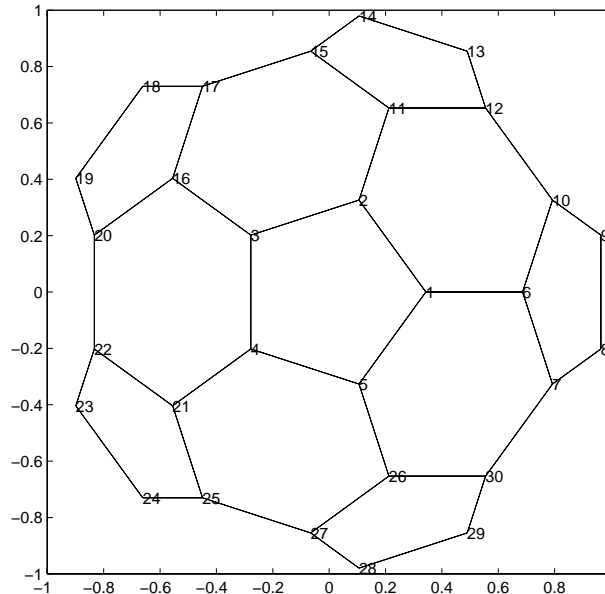

To view a template of the nonzero locations in the Bucky ball's adjacency matrix, use the `spy` function:

```
spy(B)
```

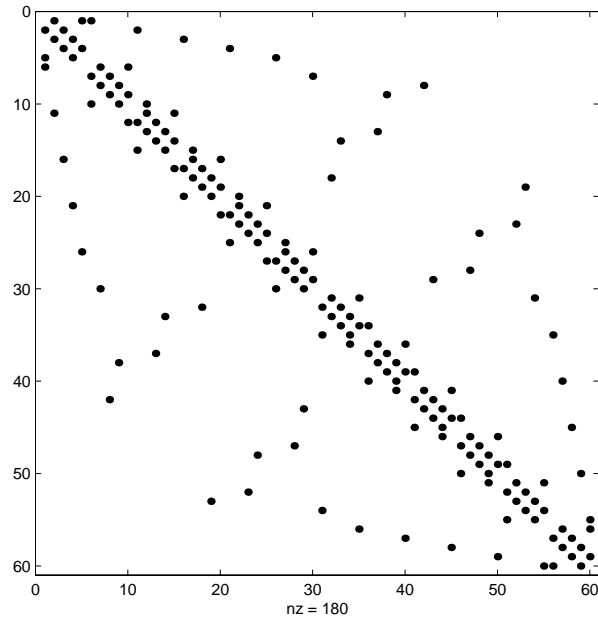



The node numbering that this model uses generates a spy plot with 12 groups of five elements, corresponding to the 12 pentagons in the structure. Each node is connected to two other nodes within its pentagon and one node in some other pentagon. Since the nodes within each pentagon have consecutive numbers, most of the elements in the first super- and sub-diagonals of B are nonzero. In addition, the symmetry of the numbering about the equator is apparent in the symmetry of the spy plot about the antidiagonal.

Graphs and Characteristics of Sparse Matrices

Spy plots of the matrix powers of B illustrate two important concepts related to sparse matrix operations, fill-in and distance. spy plots help illustrate these concepts.

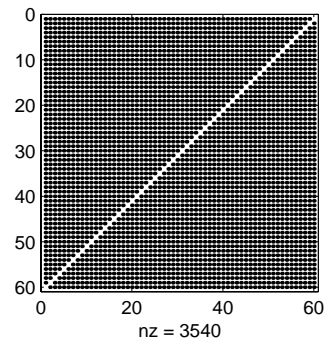
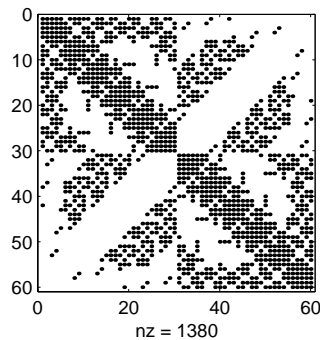
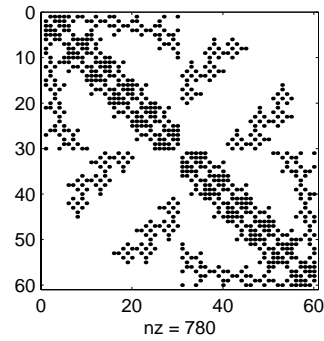
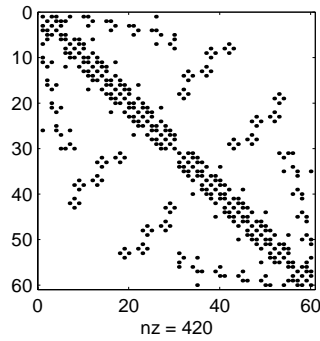
```
spy (B^2)
spy (B^3)
spy (B^4)
spy (B^8)
```



Fill-in is generated by operations like matrix multiplication. The product of two or more matrices usually has more nonzero entries than the individual terms, and so requires more storage. As p increases, B^p fills in and $\text{spy}(B^p)$ gets more dense.

The *distance* between two nodes in a graph is the number of steps on the graph necessary to get from one node to the other. The spy plot of the p -th power of B shows the nodes that are a distance p apart. As p increases, it is possible to get to more and more nodes in p steps. For the Bucky ball, B^8 is almost completely full. Only the antidiagonal is zero, indicating that it is possible to get from any node to any other node, except the one directly opposite it on the sphere, in eight steps.

An Airflow Model

A calculation performed at NASA's Research Institute for Applications of Computer Science involves modeling the flow over an airplane wing with two trailing flaps.

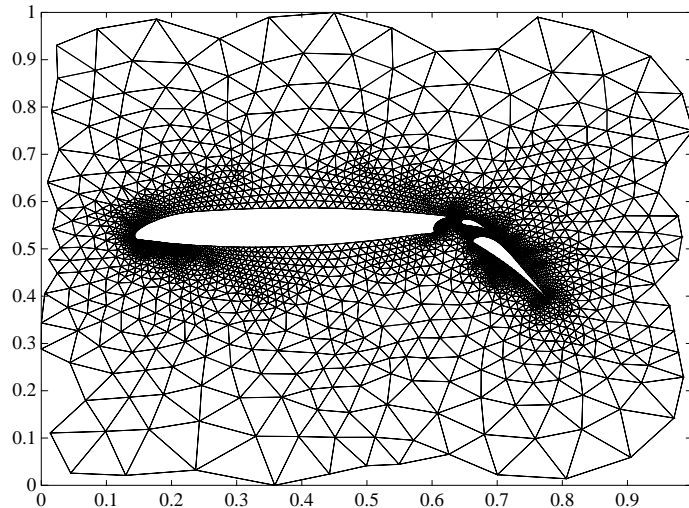

In a two-dimensional model, a triangular grid surrounds a cross section of the wing and flaps. The partial differential equations are nonlinear and involve several unknowns, including hydrodynamic pressure and two components of velocity. Each step of the nonlinear iteration requires the solution of a sparse linear system of equations. Since both the connectivity and the geometric location of the grid points are known, the `gplot` function can produce the graph shown above.

In this example, there are 4253 grid points, each of which is connected to between 3 and 9 others, for a total of 28831 nonzeros in the matrix, and a density equal to 0.0016. This `spy` plot shows that the node numbering yields a definite band structure.

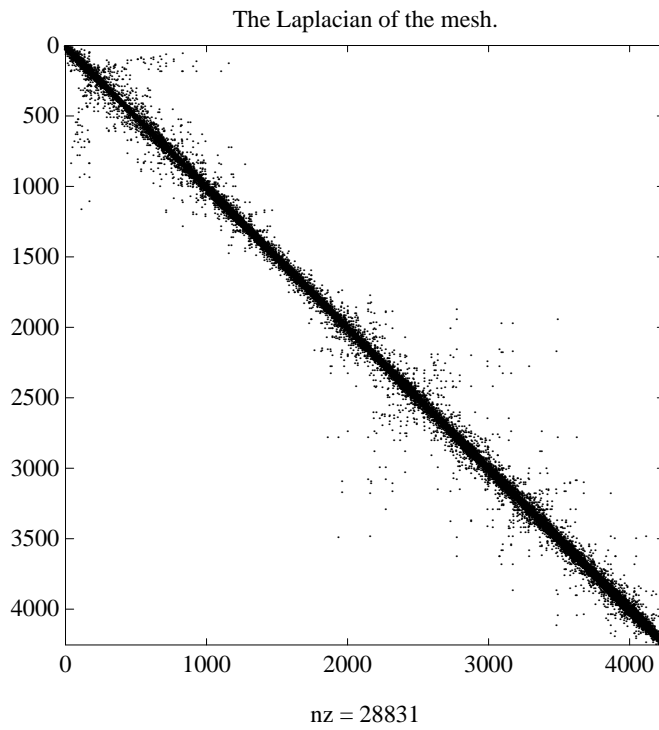

Sparse Matrix Operations

Most of MATLAB's standard mathematical functions work on sparse matrices just as they do on full matrices. In addition, MATLAB provides a number of functions that perform operations specific to sparse matrices. This section discusses:

- Computational considerations
- Standard mathematical operations
- Permutation and reordering
- Factorization
- Simultaneous linear equations
- Eigenvalues and singular values

Computational Considerations

The computational complexity of sparse operations is proportional to `nnz`, the number of nonzero elements in the matrix. Computational complexity also depends linearly on the row size `m` and column size `n` of the matrix, but is independent of the product `m*n`, the total number of zero and nonzero elements.

The complexity of fairly complicated operations, such as the solution of sparse linear equations, involves factors like ordering and fill-in, which are discussed in the previous section. In general, however, the computer time required for a sparse matrix operation is proportional to the number of arithmetic operations on nonzero quantities.

Standard Mathematical Operations

Sparse matrices propagate through computations according to these rules:

- Functions that accept a matrix and return a scalar or vector always produce output in full storage format. For example, the `size` function always returns a full vector, whether its input is full or sparse.
- Functions that accept scalars or vectors and return matrices, such as `zeros`, `ones`, `rand`, and `eye`, always return full results. This is necessary to avoid introducing sparsity unexpectedly. The sparse analog of `zeros(m,n)` is simply `sparse(m,n)`. The sparse analogs of `rand` and `eye` are `sprand` and `speye`, respectively. There is no sparse analog for the function `ones`.

- Unary functions that accept a matrix and return a matrix or vector preserve the storage class of the operand. If S is a sparse matrix, then `chol(S)` is also a sparse matrix, and `diag(S)` is a sparse vector. Columnwise functions such as `max` and `sum` also return sparse vectors, even though these vectors may be entirely nonzero. Important exceptions to this rule are the `sparse` and `full` functions.
- Binary operators yield sparse results if both operands are sparse, and full results if both are full. For mixed operands, the result is full unless the operation preserves sparsity. If S is sparse and F is full, then $S+F$, $S*F$, and $F\setminus S$ are full, while $S.*F$ and $S\&F$ are sparse. In some cases, the result might be sparse even though the matrix has few zero elements.
- Matrix concatenation using either the `cat` function or square brackets produces sparse results for mixed operands.
- Submatrix indexing on the right side of an assignment preserves the storage format of the operand unless the result is a scalar. $T = S(i, j)$ produces a sparse result if S is sparse and either i or j is a vector. It produces a full scalar if both i and j are scalars. Submatrix indexing on the left, as in $T(i, j) = S$, does not change the storage format of the matrix on the left.

Permutation and Reordering

A permutation of the rows and columns of a sparse matrix S can be represented in two ways:

- A permutation matrix P acts on the rows of S as $P*S$ or on the columns as $S*P'$.
- A permutation vector p , which is a full vector containing a permutation of $1:n$, acts on the rows of S as $S(p, :)$, or on the columns as $S(:, p)$.

For example, the statements

```
p = [1 3 4 2 5]
I = eye(5,5);
P = I(p,:);
e = ones(4,1);
S = diag(11:11:55) + diag(e,1) + diag(e,-1)
```

produce

p =

1 3 4 2 5

P =

1	0	0	0	0
0	0	1	0	0
0	0	0	1	0
0	1	0	0	0
0	0	0	0	1

S =

11	1	0	0	0
1	22	1	0	0
0	1	33	1	0
0	0	1	44	1
0	0	0	1	55

You can now try some permutations using the permutation vector p and the permutation matrix P. For example, the statements S(p, :) and P*S produce

ans =

11	1	0	0	0
0	1	33	1	0
0	0	1	44	1
1	22	1	0	0
0	0	0	1	55

Similarly, S(:, p) and S*P' produce

ans =

11	0	0	1	0
1	1	0	22	0
0	33	1	1	0
0	1	44	0	1
0	0	1	0	55

If P is a sparse matrix, then both representations use storage proportional to n and you can apply either to S in time proportional to $\text{nnz}(S)$. The vector representation is slightly more compact and efficient, so the various sparse matrix permutation routines all return full row vectors with the exception of the pivoting permutation in LU (triangular) factorization, which returns a matrix compatible with earlier versions of MATLAB.

To convert between the two representations, let $I = \text{speye}(n)$ be an identity matrix of the appropriate size. Then,

```
P = I(p, :)
P' = I(:, p)
p = (1:n)*P'
p = (P*(1:n)')'
```

The inverse of P is simply $R = P'$. You can compute the inverse of p with

```
r(p) = 1:n.
```

```
r(p) = 1:5
```

```
r =
```

```
1 4 2 3 5
```

Reordering for Sparsity

Reordering the columns of a matrix can often make its LU or QR factors sparser. Reordering the rows and columns can often make its Cholesky, factors sparser. The simplest such reordering is to sort the columns by nonzero count. This is sometimes a good reordering for matrices with very irregular structures, especially if there is great variation in the nonzero counts of rows or columns.

The function $p = \text{colperm}(S)$ computes this column-count permutation. The `colperm` M-file has only a single line.

```
[ignore, p] = sort(full(sum(spones(S))));
```

This line performs these steps:

- 1 The inner call to `spones` creates a sparse matrix with ones at the location of every nonzero element in S .

- 2 The `sum` function sums down the columns of the matrix, producing a vector that contains the count of nonzeros in each column.
- 3 `full` converts this vector to full storage format.
- 4 `sort` sorts the values in ascending order. The second output argument from `sort` is the permutation that sorts this vector.

Reordering to Reduce Bandwidth

The reverse Cuthill-McKee ordering is intended to reduce the profile or bandwidth of the matrix. It is not guaranteed to find the smallest possible bandwidth, but it usually does. The function `symrcm(A)` actually operates on the nonzero structure of the symmetric matrix $A + A'$, but the result is also useful for asymmetric matrices. This ordering is useful for matrices that come from one-dimensional problems or problems that are in some sense “long and thin.”

Minimum Degree Ordering

The degree of a node in a graph is the number of connections to that node. This is the same as the number of off-diagonal nonzero elements in the corresponding row of the adjacency matrix. The minimum degree algorithm generates an ordering based on how these degrees are altered during Gaussian elimination or Cholesky factorization. It is a complicated and powerful algorithm that usually leads to sparser factors than most other orderings, including column count and reverse Cuthill-McKee.

MATLAB functions implement two methods for each of two types of matrices: `symamd` and `symmmd` for symmetric matrices, and `colamd` and `colmmd` for nonsymmetric matrices. `colamd` and `colmmd` also work for symmetric matrices of the form $A*A'$ or $A'*A$.

Because the most time-consuming part of a minimum degree ordering algorithm is keeping track of the degree of each node, all four functions use an approximation to the degree, rather the exact degree. As a result:

- Factorizations obtained using `colmmd` and `symmmd` tend to have more nonzero elements than if the implementation used exact degrees.
- `colamd` and `symamd` use a tighter approximation than `colmmd` and `symmmd`. They generate orderings that are as good as could be obtained using exact degrees.

- `colamd` and `symamd` are faster than `colmmd` and `symmmd`, respectively. This is true particularly for very large matrices.

You can change various parameters associated with details of the algorithms using the `spparms` function.

For details on the algorithms used by `colmmd` and `symmmd`, see [4]. For details on the algorithms used by `colamd` and `symamd`, see [5]. The approximate degree used in `colamd` and `symamd` is based on [1].

Factorization

This section discusses four important factorization techniques for sparse matrices:

- LU, or triangular, factorization
- Cholesky factorization
- QR, or orthogonal, factorization
- Incomplete factorizations

LU Factorization

If S is a sparse matrix, the statement below returns three sparse matrices L , U , and P such that $P*S = L*U$.

```
[L,U,P] = lu(S)
```

`lu` obtains the factors by Gaussian elimination with partial pivoting. The permutation matrix P has only n nonzero elements. As with dense matrices, the statement `[L,U] = lu(S)` returns a permuted unit lower triangular matrix and an upper triangular matrix whose product is S . By itself, `lu(S)` returns L and U in a single matrix without the pivot information.

The sparse LU factorization does not pivot for sparsity, but it does pivot for numerical stability. In fact, both the sparse factorization (line 1) and the full factorization (line 2) below produce the same L and U , even though the time and storage requirements might differ greatly.

```
[L,U] = lu(S) % Sparse factorization
```

```
[L,U] = sparse(lu(full(S))) % Full factorization
```

You can control pivoting in sparse matrices using

```
lu(S, thresh)
```

where `thresh` is a pivot threshold in $[0,1]$. Pivoting occurs when the diagonal entry in a column has magnitude less than `thresh` times the magnitude of any sub-diagonal entry in that column. `thresh = 0` forces diagonal pivoting. `thresh = 1` is the default.

MATLAB automatically allocates the memory necessary to hold the sparse `L` and `U` factors during the factorization. MATLAB does not use any symbolic LU prefactorization to determine the memory requirements and set up the data structures in advance.

Reordering and Factorization. If you obtain a good column permutation `p` that reduces fill-in, perhaps from `symrcm` or `colamd`, then computing `lu(S(:,p))` takes less time and storage than computing `lu(S)`. Two permutations are the symmetric reverse Cuthill-McKee ordering and the symmetric minimum degree ordering.

```
r = symrcm(B);  
m = symamd(B);
```

The three `spy` plots produced by the lines below show the three adjacency matrices of the Bucky Ball graph with these three different numberings. The local, pentagon-based structure of the original numbering is not evident in the other three.

```
spy(B)  
spy(B(r,r))  
spy(B(m,m))
```

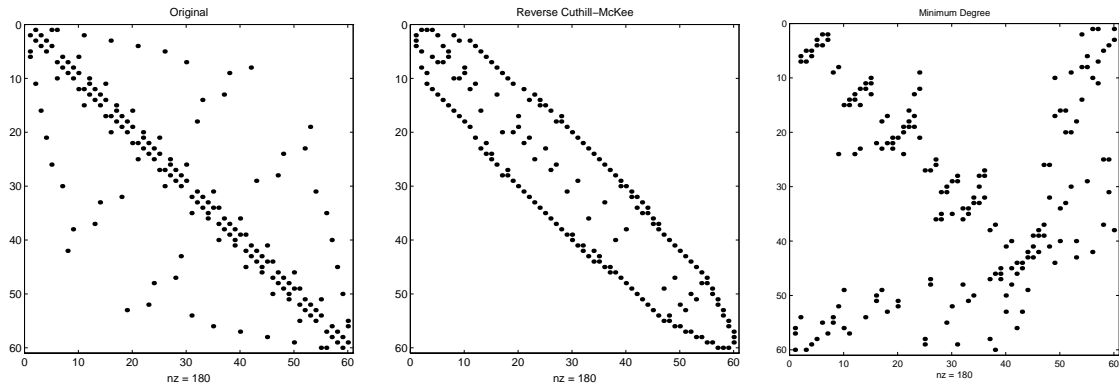

The reverse Cuthill-McKee ordering, r , reduces the bandwidth and concentrates all the nonzero elements near the diagonal. The approximate minimum degree ordering, m , produces a fractal-like structure with large blocks of zeros.

To see the fill-in generated in the LU factorization of the Bucky ball, use `speye(n,n)`, the sparse identity matrix, to insert -3 s on the diagonal of B .

$$B = B - 3 * \text{speye}(n, n);$$

Since each row sum is now zero, this new B is actually singular, but it is still instructive to compute its LU factorization. When called with only one output argument, `lu` returns the two triangular factors, L and U , in a single sparse matrix. The number of nonzeros in that matrix is a measure of the time and storage required to solve linear systems involving B . Here are the nonzero counts for the three permutations being considered.

Original	<code>lu(B)</code>	1022
Reverse Cuthill-McKee	<code>lu(B(r,r))</code>	968
Approximate minimum degree	<code>lu(B(m,m))</code>	636

Even though this is a small example, the results are typical. The original numbering scheme leads to the most fill-in. The fill-in for the reverse Cuthill-McKee ordering is concentrated within the band, but it is almost as

extensive as the first two orderings. For the minimum degree ordering, the relatively large blocks of zeros are preserved during the elimination and the amount of fill-in is significantly less than that generated by the other orderings. The spy plots below reflect the characteristics of each reordering.

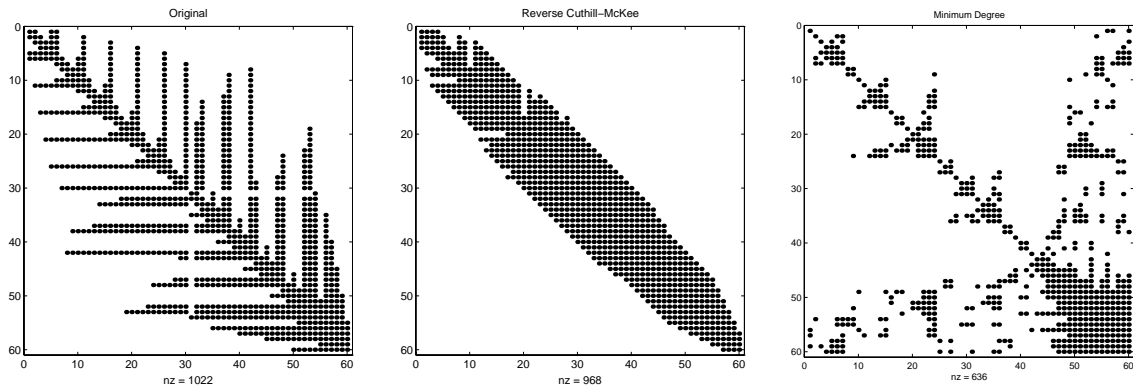

Cholesky Factorization

If S is a symmetric (or Hermitian), positive definite, sparse matrix, the statement below returns a sparse, upper triangular matrix R so that $R^T R = S$.

$$R = \text{chol}(S)$$

`chol` does not automatically pivot for sparsity, but you can compute minimum degree and profile limiting permutations for use with `chol(S(p,p))`.

Since the Cholesky algorithm does not use pivoting for sparsity and does not require pivoting for numerical stability, `chol` does a quick calculation of the amount of memory required and allocates all the memory at the start of the factorization. You can use `symbfact`, which uses the same algorithm as `chol`, to calculate how much memory is allocated.

QR Factorization

MATLAB computes the complete QR factorization of a sparse matrix S with

$$[Q,R] = \text{qr}(S)$$

but this is usually impractical. The orthogonal matrix Q often fails to have a high proportion of zero elements. A more practical alternative, sometimes known as “the Q-less QR factorization,” is available.

With one sparse input argument and one output argument

$$R = \text{qr}(S)$$

returns just the upper triangular portion of the QR factorization. The matrix R provides a Cholesky factorization for the matrix associated with the normal equations,

$$R' * R = S' * S$$

However, the loss of numerical information inherent in the computation of $S' * S$ is avoided.

With two input arguments having the same number of rows, and two output arguments, the statement

$$[C, R] = \text{qr}(S, B)$$

applies the orthogonal transformations to B , producing $C = Q' * B$ without computing Q .

The Q-less QR factorization allows the solution of sparse least squares problems

$$\text{minimize } \|Ax - b\|$$

with two steps

$$\begin{aligned} [c, R] &= \text{qr}(A, b) \\ x &= R \setminus c \end{aligned}$$

If A is sparse, but not square, MATLAB uses these steps for the linear equation solving backslash operator

$$x = A \setminus b$$

Or, you can do the factorization yourself and examine R for rank deficiency.

It is also possible to solve a sequence of least squares linear systems with different right-hand sides, b , that are not necessarily known when $R = \text{qr}(A)$ is computed. The approach solves the “semi-normal equations”

$$R' * R * x = A' * b$$

with

$$x = R \setminus (R \setminus (A' * b))$$

and then employs one step of iterative refinement to reduce roundoff error

$$\begin{aligned} r &= b - A * x \\ e &= R \setminus (R \setminus (A' * r)) \\ x &= x + e \end{aligned}$$

Incomplete Factorizations

The `luinc` and `cholinc` functions provide approximate, *incomplete* factorizations, which are useful as preconditioners for sparse iterative methods.

The `luinc` function produces two different kinds of incomplete LU factorizations, one involving a drop tolerance and one involving fill-in level. If A is a sparse matrix, and `tol` is a small tolerance, then

$$[L,U] = \text{luinc}(A, \text{tol})$$

computes an approximate LU factorization where all elements less than `tol` times the norm of the relevant column are set to zero. Alternatively,

$$[L,U] = \text{luinc}(A, '0')$$

computes an approximate LU factorization where the sparsity pattern of $L+U$ is a permutation of the sparsity pattern of A .

For example,

```
load west0479
A = west0479;
nnz(A)
nnz(lu(A))
nnz(luinc(A, 1e-6))
nnz(luinc(A, '0'))
```

shows that A has 1887 nonzeros, its complete LU factorization has 16777 nonzeros, its incomplete LU factorization with a drop tolerance of $1e-6$ has 10311 nonzeros, and its `lu('0')` factorization has 1886 nonzeros.

The `luinc` function has a few other options. See the `luinc` reference page for details.

The `cholinc` function provides drop tolerance and level 0 fill-in Cholesky factorizations of symmetric, positive definite sparse matrices. See the `cholinc` reference page for more information.

Simultaneous Linear Equations

Systems of simultaneous linear equations can be solved by two different classes of methods:

- Direct methods. These are usually variants of Gaussian elimination and are often expressed as matrix factorizations such as LU or Cholesky factorization. The algorithms involve access to the individual matrix elements.
- Iterative methods. Only an approximate solution is produced after a finite number of steps. The coefficient matrix is involved only indirectly, through a matrix-vector product or as the result of an abstract linear operator.

Direct Methods

Direct methods are usually faster and more generally applicable, if there is enough storage available to carry them out. Iterative methods are usually applicable to restricted cases of equations and depend upon properties like diagonal dominance or the existence of an underlying differential operator. Direct methods are implemented in the core of MATLAB and are made as efficient as possible for general classes of matrices. Iterative methods are usually implemented in MATLAB M-files and may make use of the direct solution of subproblems or preconditioners.

The usual way to access direct methods in MATLAB is not through the `lu` or `chol` functions, but rather with the matrix division operators `/` and `\`. If A is square, the result of $X = A \setminus B$ is the solution to the linear system $A * X = B$. If A is not square, then a least squares solution is computed.

If A is a square, full, or sparse matrix, then $A \setminus B$ has the same storage class as B . Its computation involves a choice among several algorithms:

- If A is triangular, perform a triangular solve for each column of B .
- If A is a permutation of a triangular matrix, permute it and perform a sparse triangular solve for each column of B .
- If A is symmetric or Hermitian and has positive real diagonal elements, find a symmetric minimum degree order $p = \text{symmmd}(A)$, and attempt to compute

the Cholesky factorization of $A(p, p)$. If successful, finish with two sparse triangular solves for each column of B .

- Otherwise (if A is not triangular, or is not Hermitian with positive diagonal, or if Cholesky factorization fails), find a column minimum degree order $p = \text{colmmd}(A)$. Compute the LU factorization with partial pivoting of $A(:, p)$, and perform two triangular solves for each column of B .

For a square matrix, MATLAB tries these possibilities in order of increasing cost. The tests for triangularity and symmetry are relatively fast and, if successful, allow for faster computation and more efficient memory usage than the general purpose method.

For example, consider the sequence below.

```
[L,U] = lu(A);
y = L\b;
x = U\y;
```

In this case, MATLAB uses triangular solves for both matrix divisions, since L is a permutation of a triangular matrix and U is triangular.

Using a Different Preordering. If A is not triangular or a permutation of a triangular matrix, backslash (\backslash) uses colmmd and symmmd to determine a minimum degree order. Use the function spparms to turn off the minimum degree preordering if you want to use a better preorder for a particular matrix.

If A is sparse and $x = A \backslash b$ can use LU factorization, you can use a column ordering other than colmmd to solve for x , as in the following example.

```
spparms('autommd',0);
q = colamd(A);
x = A(:,q) \ b;
x(q) = x;
spparms('autommd',1);
```

If A can be factorized using Cholesky factorization, then $x = A \backslash b$ can be computed efficiently using

```
spparms('autommd',0);
p = symamd(A);
x = A(p,p) \ b(p);
x(p) = x;
spparms('autommd',1);
```

In the examples above, the `spparms('autommd',0)` statement turns the automatic `colmmd` or `symmmd` ordering off. The `spparms('autommd',1)` statement turns it back on, just in case you use `A\b` later without specifying an appropriate pre-ordering. `spparms` with no arguments reports the current settings of the sparse parameters.

Iterative Methods

Nine functions are available that implement iterative methods for sparse systems of simultaneous linear systems.

Functions for Iterative Methods for Sparse Systems

Function	Method
<code>bicg</code>	Biconjugate gradient
<code>bicgstab</code>	Biconjugate gradient stabilized
<code>cgs</code>	Conjugate gradient squared
<code>gmres</code>	Generalized minimum residual
<code>lsqr</code>	LSQR implementation of Conjugate Gradients on the Normal Equations
<code>minres</code>	Minimum residual
<code>pcg</code>	Preconditioned conjugate gradient
<code>qmr</code>	Quasiminimal residual
<code>symmlq</code>	Symmetric LQ

These methods are designed to solve $Ax = b$ or $\min\|b - Ax\|$. For the Preconditioned Conjugate Gradient method, `pcg`, A must be a symmetric, positive definite matrix. `minres` and `symmlq` can be used on symmetric indefinite matrices. For `lsqr`, the matrix need not be square. The other five can handle nonsymmetric, square matrices.

All nine methods can make use of preconditioners. The linear system

$$Ax = b$$

is replaced by the equivalent system

$$M^{-1}Ax = M^{-1}b$$

The preconditioner M is chosen to accelerate convergence of the iterative method. In many cases, the preconditioners occur naturally in the mathematical model. A partial differential equation with variable coefficients may be approximated by one with constant coefficients, for example. Incomplete matrix factorizations may be used in the absence of natural preconditioners.

The five-point finite difference approximation to Laplace's equation on a square, two-dimensional domain provides an example. The following statements use the preconditioned conjugate gradient method preconditioner $M = R^*R$, where R is the incomplete Cholesky factor of A .

```
A = delsq(numgrid('S',50));
b = ones(size(A,1),1);
tol = 1.e-3;
maxit = 10;
R = cholinc(A,tol);
[x,flag,err,iter,res] = pcg(A,b,tol,maxit,R',R);
```

Only four iterations are required to achieve the prescribed accuracy.

Background information on these iterative methods and incomplete factorizations is available in [2] and [7].

Eigenvalues and Singular Values

Two functions are available which compute a few specified eigenvalues or singular values. `svds` is based on `eigs` which uses ARPACK [6].

Functions to Compute a Few Eigenvalues or Singular Values

Function	Description
<code>eigs</code>	Few eigenvalues
<code>svds</code>	Few singular values

These functions are most frequently used with sparse matrices, but they can be used with full matrices or even with linear operators defined by M-files.

The statement

```
[V,lambda] = eigs(A,k,sigma)
```

finds the k eigenvalues and corresponding eigenvectors of the matrix A which are nearest the “shift” σ . If σ is omitted, the eigenvalues largest in magnitude are found. If σ is zero, the eigenvalues smallest in magnitude are found. A second matrix, B , may be included for the generalized eigenvalue problem

$$Av = \lambda Bv$$

The statement

```
[U,S,V] = svds(A,k)
```

finds the k largest singular values of A and

```
[U,S,V] = svds(A,k,0)
```

finds the k smallest singular values.

For example, the statements

```
L = numgrid('L',65);  
A = delsq(L);
```

set up the five-point Laplacian difference operator on a 65-by-65 grid in an L-shaped, two-dimensional domain. The statements

```
size(A)  
nnz(A)
```

show that A is a matrix of order 2945 with 14,473 nonzero elements.

The statement

```
[v,d] = eigs(A,1,0);
```

computes the smallest eigenvalue and eigenvector. Finally,

```
L(L>0) = full(v(L(L>0)));  
x = -1:1/32:1;  
contour(x,x,L,15)  
axis square
```

distributes the components of the eigenvector over the appropriate grid points and produces a contour plot of the result.

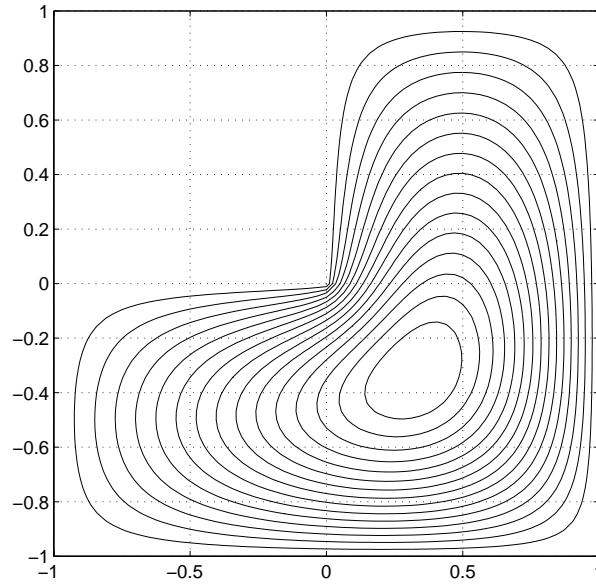

The numerical techniques used in `eigs` and `svds` are described in [6].

Selected Bibliography

- [1] Amestoy, P. R., T. A. Davis, and I. S. Duff, "An Approximate Minimum Degree Ordering Algorithm," *SIAM Journal on Matrix Analysis and Applications*, Vol. 17, No. 4, Oct. 1996, pp. 886-905.
- [2] Barrett, R., M. Berry, T. F. Chan, et al., *Templates for the Solution of Linear Systems: Building Blocks for Iterative Methods*, SIAM, Philadelphia, 1994.
- [3] Davis, T.A., Gilbert, J. R., Larimore, S.I., Ng, E., Peyton, B., "A Column Approximate Minimum Degree Ordering Algorithm," *Proc. SIAM Conference on Applied Linear Algebra*, Oct. 1997, p. 29.
- [4] Gilbert, John R., Cleve Moler, and Robert Schreiber, "Sparse Matrices in MATLAB: Design and Implementation," *SIAM J. Matrix Anal. Appl.*, Vol. 13, No. 1, January 1992, pp. 333-356.
- [5] Larimore, S. I., *An Approximate Minimum Degree Column Ordering Algorithm*, MS Thesis, Dept. of Computer and Information Science and Engineering, University of Florida, Gainesville, FL, 1998, available at <http://www.cise.ufl.edu/tech-reports/>
- [6] Lehoucq, R. B., D. C. Sorensen, C. Yang, *ARPACK Users' Guide*, SIAM, Philadelphia, 1998.
- [7] Saad, Yousef, *Iterative Methods for Sparse Linear Equations*. PWS Publishing Company, 1996.

Programming and Data Types

MATLAB is a high-level language that includes data structures, functions, control flow statements, input/output, and object-oriented capabilities. This section presents MATLAB's programming features and techniques in the following chapters:

- **M-File Programming** – describes language constructs and how to create MATLAB programs (M-files). It covers data types, flow control, array indexing, optimizing performance, and other topics.
- **Character Arrays** – covers MATLAB's support for string data, including how to create character arrays and cell arrays of strings, ways to represent strings, how to perform common string operations, and conversion between string and numeric formats.
- **Multidimensional Arrays** – discusses the use of MATLAB arrays having more than two dimensions. It covers array creation, array indexing, data organization, and how MATLAB functions operate on these arrays.
- **Structures and Cell Arrays** – describes two MATLAB data types that provide hierarchical storage for dissimilar kinds of data. Structures contain different kinds of data organized by named fields. Cell arrays consist of cells that themselves contain MATLAB arrays.
- **Function Handles** - describes how you use the MATLAB function handle to capture certain information about a function, including function references, that you can then use to execute the function from anywhere in the MATLAB environment.
- **MATLAB Classes and Objects** – presents MATLAB's object-oriented programming capabilities. Classes and objects enable you to add new data types and new operations to MATLAB. This section also includes examples of how to implement well-behaved classes in MATLAB.

Related Information

The following sections provide information that is also useful to MATLAB programmers. This documentation is available in MATLAB's online help.

- Graphics – describes how to plot vector and matrix data in 2-D and 3-D representations, how to annotate, print, and export plots, and how to use graphics objects and their figure and axes properties.
- Calling C and Fortran Programs from MATLAB - describes how to build C and Fortran subroutines into callable MEX files.
- Calling MATLAB from C and Fortran Programs - discusses how to use the MATLAB engine library to call MATLAB from C and Fortran programs.
- Calling Java from MATLAB - describes how to use the MATLAB interface to Java classes and objects.
- Importing and Exporting Data - describes techniques for importing data to and exporting data from the MATLAB environment.
- ActiveX and DDE Support - describes how to use ActiveX and Dynamic Data Exchange (DDE) with MATLAB.
- Serial Port I/O - describes how to communicate with peripheral devices such as modems, printers, and scientific instruments that you connect to your computer's serial port.

M-File Programming

MATLAB Programming: A Quick Start	17-3
Scripts	17-7
Functions	17-8
Local and Global Variables	17-19
Data Types	17-22
Keywords	17-25
Operators	17-26
Flow Control	17-35
Subfunctions	17-43
Private Functions	17-45
Subscripting and Indexing	17-46
String Evaluation	17-54
Command/Function Duality	17-56
Empty Matrices	17-57
Errors and Warnings	17-59
Dates and Times	17-62
Obtaining User Input	17-69
Shell Escape Functions	17-70
Optimizing MATLAB Code	17-71

MATLAB provides a full programming language that enables you to write a series of MATLAB statements into a file and then execute them with a single command. You write your program in an ordinary text file, giving the file a name of `filename.m`. The term you use for `filename` becomes the new command that MATLAB associates with the program. The file extension of `.m` makes this a MATLAB M-file.

This chapter explains the basics of how to write script and function programs in M-files. It covers the following topics:

- “MATLAB Programming: A Quick Start”
- “Scripts”
- “Functions”
- “Local and Global Variables”
- “Data Types”
- “Operators”
- “Flow Control”
- “Subfunctions”
- “Private Functions”
- “Subscripting and Indexing”
- “String Evaluation”
- “Command/Function Duality”
- “Empty Matrices”
- “Errors and Warnings”
- “Dates and Times”
- “Obtaining User Input”
- “Shell Escape Functions”
- “Optimizing MATLAB Code”

MATLAB Programming: A Quick Start

M-files can be *scripts* that simply execute a series of MATLAB statements, or they can be *functions* that also accept arguments and produce output. You create M-files using a text editor, then use them as you would any other MATLAB function or command.

The process looks like this:

- 1 Create an M-file using a text editor.

```
function c = myfile(a,b)
c = sqrt((a.^2)+(b.^2))
```



- 2 Call the M-file from the command line, or from within another M-file.

```
a = 7.5
b = 3.342
c = myfile(a,b)

c =

    8.2109
```

Kinds of M-Files

There are two kinds of M-files.

Script M-Files	Function M-Files
<ul style="list-style-type: none"> • Do not accept input arguments or return output arguments 	<ul style="list-style-type: none"> • Can accept input arguments and return output arguments
<ul style="list-style-type: none"> • Operate on data in the workspace 	<ul style="list-style-type: none"> • Internal variables are local to the function by default
<ul style="list-style-type: none"> • Useful for automating a series of steps you need to perform many times 	<ul style="list-style-type: none"> • Useful for extending the MATLAB language for your application

What's in an M-File?

This section shows you the basic parts of a function M-file, so you can familiarize yourself with MATLAB programming and get started with some examples.

```
function f = fact(n) % Function definition line
% FACT Factorial.    % H1 line
% FACT(N) returns the factorial of N, H! % Help text
% usually denoted by N!
% Put simply, FACT(N) is PROD(1:N).

f = prod(1:n);      % Function body
```

This function has some elements that are common to all MATLAB functions:

- A *function definition line*. This line defines the function name, and the number and order of input and output arguments.
- An *H1 line*. H1 stands for “help 1” line. MATLAB displays the H1 line for a function when you use `lookfor` or request help on an entire directory.
- *Help text*. MATLAB displays the help text entry together with the H1 line when you request help on a specific function.
- The *function body*. This part of the function contains code that performs the actual computations and assigns values to any output arguments.

Refer to “Functions” on page 17-8 for more detail on the parts of a MATLAB function.

Providing Help for Your Programs

You can provide user information for the programs you write by including a help text section at the beginning of your M-file. This section starts on the line following the function definition and ends at the first blank line. Each line of the help text must begin with a comment (%) character. MATLAB displays this information whenever you type

```
help m-file_name
```

You can also make help entries for an entire directory by creating a file with the special name `Contents.m` that resides in the directory. This file must contain only comment lines; that is, every line must begin with a percent sign. MATLAB displays the lines in a `Contents.m` file whenever you type

```
help directory_name
```

If a directory does not contain a `Contents.m` file, typing `help directory_name` displays the first help line (the H1 line) for each M-file in the directory.

Creating M-Files: Accessing Text Editors

M-files are ordinary text files that you create using a text editor. MATLAB provides a built-in editor, although you can use any text editor you like.

Note To open the editor on the PC, from the **File** menu, choose **New**, and then **M-File**.

Another way to edit an M-file is from the MATLAB command line using the `edit` function. For example,

```
edit foo
```

opens the editor on the file `foo.m`. Omitting a filename opens the editor on an untitled file.

You can create the `fact` function shown on the previous page by opening your text editor, entering the lines shown, and saving the text in a file called `fact.m` in your current directory.

Once you've created this file, here are some things you can do:

- List the names of the files in your current directory

```
what
```

- List the contents of M-file `fact.m`

```
type fact
```

- Call the fact function

```
fact(5)
```

```
ans =
```

```
120
```

Note Save any M-files you create and any MATLAB-supplied M-files that you edit in a directory that is not in the MATLAB directory tree. If you keep your files in the MATLAB directory tree, they may be overwritten when you install a new version of MATLAB. Also note that the locations of files in the MATLAB/toolbox directory tree are loaded and cached in memory at the beginning of each MATLAB session to improve performance. If you do save a new or edited file in the MATLAB/toolbox directory tree, restart MATLAB or use the rehash function to reload the directory and update the cache before you use the file.

Scripts

Scripts are the simplest kind of M-file because they have no input or output arguments. They're useful for automating series of MATLAB commands, such as computations that you have to perform repeatedly from the command line. Scripts operate on existing data in the workspace, or they can create new data on which to operate. Any variables that scripts create remain in the workspace after the script finishes so you can use them for further computations.

Simple Script Example

These statements calculate rho for several trigonometric functions of theta, then create a series of polar plots.

```
% An M-file script to produce          % Comment lines
% "flower petal" plots
theta = -pi:0.01:pi;                  % Computations
rho(1,:) = 2*sin(5*theta).^2;
rho(2,:) = cos(10*theta).^3;
rho(3,:) = sin(theta).^2;
rho(4,:) = 5*cos(3.5*theta).^3;
for k = 1:4
    polar(theta,rho(k,:))              % Graphics output
    pause
end
```

Try entering these commands in an M-file called `petals.m`. This file is now a MATLAB script. Typing `petals` at the MATLAB command line executes the statements in the script.

After the script displays a plot, press **Return** to move to the next plot. There are no input or output arguments; `petals` creates the variables it needs in the MATLAB workspace. When execution completes, the variables (`i`, `theta`, and `rho`) remain in the workspace. To see a listing of them, enter `whos` at the command prompt.

Functions

Functions are M-files that accept input arguments and return output arguments. They operate on variables within their own workspace. This is separate from the workspace you access at the MATLAB command prompt.

This section covers the following topics regarding functions:

- “Simple Script Example”
- “Basic Parts of a Function M-File”
- “Function Names”
- “How Functions Work”
- “Checking the Number of Function Arguments”
- “Passing Variable Numbers of Arguments”

Simple Function Example

The average function is a simple M-file that calculates the average of the elements in a vector.

```
function y = average(x)
% AVERAGE Mean of vector elements.
% AVERAGE(X), where X is a vector, is the mean of vector elements.
% Non-vector input results in an error.
[m,n] = size(x);
if ~(m == 1 | n == 1) | (m == 1 & n == 1)
    error('Input must be a vector')
end
y = sum(x)/length(x);      % Actual computation
```

If you would like, try entering these commands in an M-file called `average.m`. The average function accepts a single input argument and returns a single output argument. To call the average function, enter

```
z = 1:99;

average(z)

ans =
    50
```

Basic Parts of a Function M-File

A function M-file consists of:

- “The Function Definition Line”
- “The H1 Line”
- “Help Text”
- “The Function Body”
- “Comments”

The Function Definition Line

The function definition line informs MATLAB that the M-file contains a function, and specifies the argument calling sequence of the function. The function definition line for the average function is

```
function y = average(x)
```

Diagram illustrating the components of the function definition line `function y = average(x)`:

- `function`: keyword
- `y`: output argument
- `average`: function name
- `x`: input argument

All MATLAB functions have a function definition line that follows this pattern.

If the function has multiple output values, enclose the output argument list in square brackets. Input arguments, if present, are enclosed in parentheses. Use commas to separate multiple input or output arguments. Here’s a more complicated example.

```
function [x,y,z] = sphere(theta,phi,rho)
```

If there is no output, leave the output blank

```
function printresults(x)
```

or use empty square brackets

```
function [] = printresults(x)
```

The variables that you pass to the function do not need to have the same name as those in the function definition line.

The H1 Line

The H1 line, so named because it is the first help text line, is a comment line immediately following the function definition line. Because it consists of comment text, the H1 line begins with a percent sign, “%.” For the average function, the H1 line is

```
% AVERAGE Mean of vector elements.
```

This is the first line of text that appears when a user types `help function_name` at the MATLAB prompt. Further, the `lookfor` function searches on and displays only the H1 line. Because this line provides important summary information about the M-file, it is important to make it as descriptive as possible.

Help Text

You can create online help for your M-files by entering text on one or more comment lines, beginning with the line immediately following the H1 line. The help text for the average function is

```
% AVERAGE(X), where X is a vector, is the mean of vector elements.  
% Nonvector input results in an error.
```

When you type `help function_name`, MATLAB displays the comment lines that appear between the function definition line and the first non-comment (executable or blank) line. The help system ignores any comment lines that appear after this help block.

For example, typing `help sin` results in

```
SIN      Sine.  
SIN(X)  is the sine of the elements of X.
```

The Function Body

The function body contains all the MATLAB code that performs computations and assigns values to output arguments. The statements in the function body can consist of function calls, programming constructs like flow control and interactive input/output, calculations, assignments, comments, and blank lines.

For example, the body of the average function contains a number of simple programming statements.

```
[m,n] = size(x);  
if (~(m == 1) | (n == 1)) | (m == 1 & n == 1) % Flow control  
    error('Input must be a vector') % Error message display  
end  
y = sum(x)/length(x); % Computation and assignment
```

Comments

As mentioned earlier, comment lines begin with a percent sign (%). Comment lines can appear anywhere in an M-file, and you can append comments to the end of a line of code. For example,

```
% Add up all the vector elements.  
y = sum(x) % Use the sum function.
```

The first comment line immediately following the function definition line is considered the H1 line for the function. The H1 line and any comment lines immediately following it constitute the online help entry for the file.

In addition to comment lines, you can insert blank lines anywhere in an M-file. Blank lines are ignored. However, a blank line can indicate the end of the help text entry for an M-file.

Function Names

MATLAB function names have the same constraints as variable names. MATLAB uses the first 31 characters of names. Function names must begin with a letter; the remaining characters can be any combination of letters, numbers, and underscores. Some operating systems may restrict function names to shorter lengths.

The name of the text file that contains a MATLAB function consists of the function name with the extension `.m` appended. For example,

```
average.m
```

If the filename and the function definition line name are different, the internal name is ignored.

Thus, while the function name specified on the function definition line does not have to be the same as the filename, we strongly recommend that you use the same name for both.

How Functions Work

You can call function M-files from either the MATLAB command line or from within other M-files. Be sure to include all necessary arguments, enclosing input arguments in parentheses and output arguments in square brackets.

This section provides the following information on calling MATLAB functions:

- “Function Name Resolution”
- “What Happens When You Call a Function”
- “Creating P-Code Files”
- “How MATLAB Passes Function Arguments”
- “Function Workspaces”

Function Name Resolution

When MATLAB comes upon a new name, it resolves it into a specific function by following these steps:

- 1 Checks to see if the name is a variable.
- 2 Checks to see if the name is a *subfunction*, a MATLAB function that resides in the same M-file as the calling function. Subfunctions are discussed in the section, “Subfunctions” on page 17-43.
- 3 Checks to see if the name is a *private function*, a MATLAB function that resides in a *private directory*, a directory accessible only to M-files in the directory immediately above it. Private directories are discussed in the section, “Private Functions” on page 17-45.
- 4 Checks to see if the name is a function on the MATLAB search path. MATLAB uses the first file it encounters with the specified name.

If you duplicate function names, MATLAB executes the one found first using the above rules. It is also possible to overload function names. This uses additional dispatching rules and is discussed in the section, “How MATLAB Determines Which Method to Call” on page 22-67.

What Happens When You Call a Function

When you call a function M-file from either the command line or from within another M-file, MATLAB parses the function into pseudocode and stores it in memory. This prevents MATLAB from having to reparse a function each time you call it during a session. The pseudocode remains in memory until you clear it using the `clear` function, or until you quit MATLAB.

You can use `clear` in any of the following ways to remove functions from the MATLAB workspace.

Syntax	Description
<code>clear function_name</code>	Remove specified function from workspace
<code>clear functions</code>	Remove all compiled M-functions
<code>clear all</code>	Remove all variables and functions

Creating P-Code Files

You can save a parsed version of a function or script, called P-code files, for later MATLAB sessions using the `pcode` function. For example,

```
pcode average
```

parses `average.m` and saves the resulting pseudocode to the file named `average.p`. This saves MATLAB from reparsing `average.m` the first time you call it in each session.

MATLAB is very fast at parsing so the `pcode` function rarely makes much of a speed difference.

One situation where `pcode` does provide a speed benefit is for large GUI applications. In this case, many M-files must be parsed before the application becomes visible.

Another situation for `pcode` is when, for proprietary reasons, you want to hide algorithms you've created in your M-file.

How MATLAB Passes Function Arguments

From the programmer's perspective, MATLAB appears to pass all function arguments by value. Actually, however, MATLAB passes by value only those arguments that a function modifies. If a function does not alter an argument but simply uses it in a computation, MATLAB passes the argument by reference to optimize memory use.

Function Workspaces

Each M-file function has an area of memory, separate from MATLAB's base workspace, in which it operates. This area is called the function workspace, with each function having its own workspace context.

While using MATLAB, the only variables you can access are those in the calling context, be it the base workspace or that of another function. The variables that you pass to a function must be in the calling context, and the function returns its output arguments to the calling workspace context. You can however, define variables as global variables explicitly, allowing more than one workspace context to access them.

Checking the Number of Function Arguments

The `nargin` and `nargout` functions let you determine how many input and output arguments a function is called with. You can then use conditional statements to perform different tasks depending on the number of arguments. For example,

```
function c = testarg1(a,b)
if (nargin == 1)
    c = a.^2;
elseif (nargin == 2)
    c = a + b;
end
```

Given a single input argument, this function squares the input value. Given two inputs, it adds them together.

Here's a more advanced example that finds the first token in a character string. A *token* is a set of characters delimited by whitespace or some other character. Given one input, the function assumes a default delimiter of whitespace; given two, it lets you specify another delimiter if desired. It also allows for two possible output argument lists.

```
function [token,remainder] = strtok(string,delimiters)
% Function requires at least one input argument
if nargin < 1
    error('Not enough input arguments.');
```

```
end
token = []; remainder = [];
len = length(string);
if len == 0
    return
end

% If one input, use white space delimiter
if (nargin == 1)
    delimiters = [9:13 32]; % White space characters
end
i = 1;

% Determine where non-delimiter characters begin
while (any(string(i) == delimiters))
    i = i + 1;
    if (i > len), return, end
end

% Find where token ends
start = i;
while (~any(string(i) == delimiters))
    i = i + 1;
    if (i > len), break, end
end
finish = i - 1;
token = string(start:finish);

% For two output arguments, count characters after
% first delimiter (remainder)
if (nargout == 2)
    remainder = string(finish + 1:end);
end
```

The `strtok` function is a MATLAB M-file in the `strfun` directory.

Note The order in which output arguments appear in the function declaration line is important. The argument that the function returns in most cases appears first in the list. Additional, optional arguments are appended to the list.

Passing Variable Numbers of Arguments

The `varargin` and `varargout` functions let you pass any number of inputs or return any number of outputs to a function. This section describes how to use these functions and also covers:

- “Unpacking `varargin` Contents”
- “Packing `varargout` Contents”
- “`varargin` and `varargout` in Argument Lists”

MATLAB packs all specified input arguments into a *cell array*, a special kind of MATLAB array that consists of cells instead of array elements. Each cell can hold any size or kind of data – one might hold a vector of numeric data, another in the same array might hold an array of string data, and so on. For output arguments, your function code must pack them into a cell array so that MATLAB can return the arguments to the caller.

Here’s an example function that accepts any number of two-element vectors and draws a line to connect them.

```
function testvar(varargin)
for k = 1:length(varargin)
    x(k) = varargin{k}(1); % Cell array indexing
    y(k) = varargin{k}(2);
end
xmin = min(0,min(x));
ymin = min(0,min(y));
axis([xmin fix(max(x))+3 ymin fix(max(y))+3])
plot(x,y)
```

Coded this way, the `testvar` function works with various input lists; for example,

```
testvar([2 3],[1 5],[4 8],[6 5],[4 2],[2 3])
testvar([-1 0],[3 -5],[4 2],[1 1])
```

Unpacking varargin Contents

Because `varargin` contains all the input arguments in a cell array, it's necessary to use cell array indexing to extract the data. For example,

```
y(i) = varargin{i}(2);
```

Cell array indexing has two subscript components:

- The cell indexing expression, in curly braces
- The contents indexing expression(s), in parentheses

In the code above, the indexing expression `{i}` accesses the *i*'th cell of `varargin`. The expression `(2)` represents the second element of the cell contents.

Packing varargin Contents

When allowing any number of output arguments, you must pack all of the output into the `varargout` cell array. Use `nargout` to determine how many output arguments the function is called with. For example, this code accepts a two-column input array, where the first column represents a set of *x* coordinates and the second represents *y* coordinates. It breaks the array into separate `[xi yi]` vectors that you can pass into the `testvar` function on the previous page.

```
function [varargout] = testvar2(arrayin)
for k = 1:nargout
    varargout{k} = arrayin(k,:) % Cell array assignment
end
```

The assignment statement inside the `for` loop uses cell array assignment syntax. The left side of the statement, the cell array, is indexed using curly braces to indicate that the data goes inside a cell. For complete information on cell array assignment, see the “Structures and Cell Arrays” section.

Here's how to call `testvar2`.

```
a = {1 2;3 4;5 6;7 8;9 0};  
[p1,p2,p3,p4,p5] = testvar2(a);
```

varargin and varargout in Argument Lists

`varargin` or `varargout` must appear last in the argument list, following any required input or output variables. That is, the function call must specify the required arguments first. For example, these function declaration lines show the correct placement of `varargin` and `varargout`.

```
function [out1,out2] = example1(a,b,varargin)  
function [i,j,varargout] = example2(x1,y1,x2,y2,flag)
```

Local and Global Variables

The same guidelines that apply to MATLAB variables at the command line also apply to variables in M-files:

- You do not need to type or declare variables. Before assigning one variable to another, however, you must be sure that the variable on the right-hand side of the assignment has a value.
- Any operation that assigns a value to a variable creates the variable if needed, or overwrites its current value if it already exists.
- MATLAB variable names consist of a letter followed by any number of letters, digits, and underscores. MATLAB distinguishes between uppercase and lowercase characters, so A and a are not the same variable.
- MATLAB uses only the first 31 characters of variable names.

Ordinarily, each MATLAB function, defined by an M-file, has its own local variables, which are separate from those of other functions, and from those of the base workspace. However, if several functions, and possibly the base workspace, all declare a particular name as global, then they all share a single copy of that variable. Any assignment to that variable, in any function, is available to all the other functions declaring it global.

Suppose you want to study the effect of the interaction coefficients, α and β , in the Lotka-Volterra predator-prey model.

$$\dot{y}_1 = y_1 - \alpha y_1 y_2$$

$$\dot{y}_2 = -y_2 + \beta y_1 y_2$$

Create an M-file, `lotka.m`.

```
function yp = lotka(t,y)
%LOTKA Lotka-Volterra predator-prey model.
global ALPHA BETA
yp = [y(1) - ALPHA*y(1)*y(2); -y(2) + BETA*y(1)*y(2)];
```

Then interactively enter the statements

```
global ALPHA BETA
ALPHA = 0.01
BETA = 0.02
```

```
[t,y] = ode23('lotka',0,10,[1; 1]);  
plot(t,y)
```

The two global statements make the values assigned to ALPHA and BETA at the command prompt available inside the function defined by `lotka.m`. They can be modified interactively and new solutions obtained without editing any files.

For your MATLAB application to work with global variables:

- Declare the variable as `global` in every function that requires access to it. To enable the workspace to access the global variable, also declare it as `global` from the command line.
- In each function, issue the `global` command before the first occurrence of the variable name. The top of the M-file is recommended.

MATLAB global variable names are typically longer and more descriptive than local variable names, and sometimes consist of all uppercase characters. These are not requirements, but guidelines to increase the readability of MATLAB code and reduce the chance of accidentally redefining a global variable.

Persistent Variables

A variable may be defined as `persistent` so that it does not change value from one call to another. Persistent variables may be used within a function only. Persistent variables remain in memory until the M-file is cleared or changed.

`persistent` is exactly like `global`, except that the variable name is not in the global workspace, and the value is reset if the M-file is changed or cleared.

Three MATLAB functions support the use of persistent variables.

Function	Description
<code>mlock</code>	Prevents an M-file from being cleared
<code>munlock</code>	Unlocks an M-file that had previously been locked by <code>mlock</code>
<code>mislocked</code>	Indicates whether an M-file can be cleared or not

Special Values

Several functions return important special values that you can use in your M-files.

Function	Return Value
ans	Most recent answer (variable). If you do not assign an output variable to an expression, MATLAB automatically stores the result in ans.
eps	Floating-point relative accuracy. This is the tolerance MATLAB uses in its calculations.
realmax	Largest floating-point number your computer can represent.
realmin	Smallest floating-point number your computer can represent.
pi	3.1415926535897...
i, j	Imaginary unit.
inf	Infinity. Calculations like $n/0$, where n is any nonzero real value, result in inf.
NaN	Not-a-Number, an invalid numeric value. Expressions like $0/0$ and inf/inf result in a NaN, as do arithmetic operations involving a NaN. $n/0$, where n is complex, also returns NaN.
computer	Computer type.
version	MATLAB version string.

Here are several examples that use these values in MATLAB expressions.

```
x = 2*pi;
A = [3+2i 7-8i];
tol = 3*eps;
```

Data Types

There are 14 fundamental data types (or classes) in MATLAB. Each of these data types is in the form of an array. This array is a minimum of 0-by-0 in size and can grow to an n-dimensional array of any size. Two-dimensional versions of these arrays are called *matrices*.

All of the fundamental data types are shown in lowercase text in the diagram below. An additional, user-defined data type, shown below as *user class*, is a subset of the structure type.

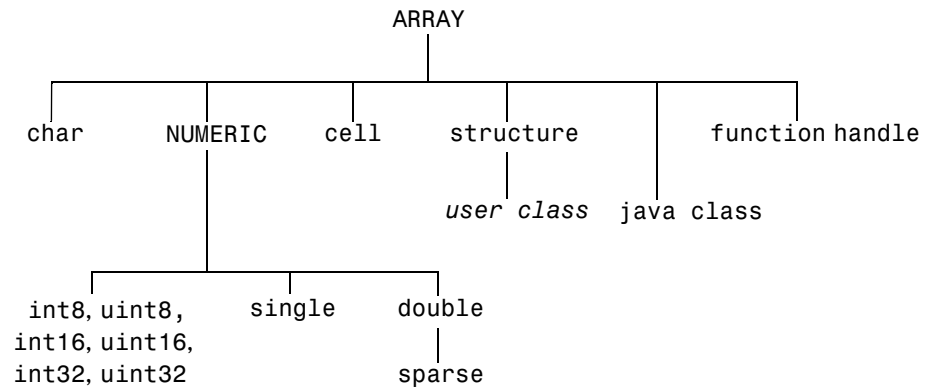

The `char` data type holds characters in Unicode representation. A character string is merely a 1-by-n array of characters. You can use `char` to hold an array of strings as long as each string in the array has the same length. (This is because MATLAB arrays must be rectangular.) To hold an array of strings of unequal length, use a `cell` array.

Numeric data types include signed and unsigned integers, single- and double-precision floating point, and sparse matrices of double-precision. The following hold true for numeric data types in MATLAB:

- All MATLAB computations are done in double-precision.
- Integer and single precision arrays offer more memory efficient storage than double-precision.
- All data types support basic array operations, such as subscripting and reshaping.

- To perform mathematical operations on integer or single precision arrays, you must convert them to double precision using the `double` function.

A `cell` array provides a storage mechanism for dissimilar kinds of data. You can store arrays of different types and/or sizes within the cells of a `cell` array. For example, you can store a 1-by-50 `char` array, a 7-by-13 `double` array, and a 1-by-1 `uint32` in cells of the same `cell` array. You access data in a `cell` array using the same matrix indexing used on other MATLAB matrices and arrays.

The MATLAB structure data type is similar to the `cell` array in that it also stores dissimilar kinds of data. But, in this case, it stores the data in named fields rather than in cells. This enables you to attach a name to the groups of data stored within the structure. You access data in a structure using these same field names.

MATLAB data types are implemented as classes. You can also create MATLAB classes of your own. These user-defined classes inherit from the MATLAB structure class and are shown in the previous diagram as a subset of structure.

MATLAB provides an interface to the Java programming language that enables you to create objects from Java classes and call Java methods on these objects. A Java class is a MATLAB data type. There are built-in and third-party classes that are already available through the MATLAB interface. You can also create your own Java class definitions and bring them into MATLAB.

A function handle holds information to be used in referencing a function. When you create a function handle, MATLAB captures all the information about the function that it needs to locate and execute, or *evaluate*, it later on. Typically, a function handle is passed in an argument list to other functions. It is then used in conjunction with `feval` to evaluate the function to which the handle belongs.

The following table describes the data types in more detail.

Data Type	Example	Description
<code>single</code>	<code>3*10^38</code>	Single-precision numeric array. Single precision requires less storage than double precision, but has less precision and a smaller range. This data type cannot be used in mathematical operations.

Data Type	Example	Description
double	<code>3*10^300</code> <code>5+6i</code>	Double-precision numeric array. This is the most common MATLAB variable type.
sparse	<code>speye(5)</code>	Sparse double-precision matrix (2-D only). The sparse matrix stores matrices with only a few nonzero elements in a fraction of the space required for an equivalent full matrix. Sparse matrices invoke special methods especially tailored to solve sparse problems.
int8, uint8, int16, uint16, int32, uint32	<code>uint8(magic(3))</code>	Signed and unsigned integer arrays that are 8, 16, and 32 bits in length. Enables you to manipulate integer quantities in a memory efficient manner. These data types cannot be used in mathematical operations.
char	<code>'Hello'</code>	Character array (each character is 16 bits long). This array is also referred to as a string.
cell	<code>{17 'hello' eye(2)}</code>	Cell array. Elements of cell arrays contain other arrays. Cell arrays collect related data and information of a dissimilar size together.
structure	<code>a.day = 12;</code> <code>a.color = 'Red';</code> <code>a.mat = magic(3);</code>	Structure array. Structure arrays have field names. The fields contain other arrays. Like cell arrays, structures collect related data and information together.
user class	<code>inline('sin(x)')</code>	MATLAB class. This user-defined class is created using MATLAB functions.
java class	<code>java.awt.Frame</code>	Java class. You can use classes already defined in the Java API or by a third party, or create your own classes in the Java language.
function handle	<code>@humps</code>	Handle to a MATLAB function. A function handle can be passed in an argument list and evaluated using <code>feval</code> .

Keywords

MATLAB reserves certain words for its own use as keywords of the language. To list the keywords, type

```
iskeyword

ans =

    'break'
    'case'
    'catch'
    'continue'
    'else'
    'elseif'
    'end'
    'for'
    'function'
    'global'
    'if'
    'otherwise'
    'persistent'
    'return'
    'switch'
    'try'
    'while'
```

See the online function reference pages for help to learn how to use any of these keywords.

You should not use MATLAB keywords other than for their intended purpose. For example, a keyword should not be used as follows:

```
while = 5;
??? while = 5;
    |
Error: Expected a variable, function, or constant, found "=".
```

Operators

MATLAB's operators fall into three categories:

- Arithmetic operators that perform numeric computations, for example, adding two numbers or raising the elements of an array to a given power.
- Relational operators that compare operands quantitatively, using operators like “less than” and “not equal to.”
- Logical operators that use the logical operators AND, OR, and NOT.

This section also discusses operator precedence.

Arithmetic Operators

MATLAB provides these arithmetic operators

Operator	Description
+	Addition
−	Subtraction
.*	Multiplication
./	Right division
.\	Left division
+	Unary plus
−	Unary minus
:	Colon operator
.^	Power
.'	Transpose
'	Complex conjugate transpose
*	Matrix multiplication
/	Matrix right division

Operator	Description
\	Matrix left division
^	Matrix power

Arithmetic Operators and Arrays

Except for some matrix operators, MATLAB's arithmetic operators work on corresponding elements of arrays with equal dimensions. For vectors and rectangular arrays, both operands must be the same size unless one is a scalar. If one operand is a scalar and the other is not, MATLAB applies the scalar to every element of the other operand – this property is known as *scalar expansion*.

This example uses scalar expansion to compute the product of a scalar operand and a matrix.

```
A = magic(3)
```

```
A =
```

```
     8     1     6
     3     5     7
     4     9     2
```

```
3 * A
```

```
ans =
```

```
    24     3    18
     9    15    21
    12    27     6
```

Relational Operators

MATLAB provides these relational operators.

Operator	Description
<	Less than
<=	Less than or equal to
>	Greater than
>=	Greater than or equal to
==	Equal to
~=	Not equal to

Relational Operators and Arrays

MATLAB's relational operators compare corresponding elements of arrays with equal dimensions. Relational operators always operate element-by-element. In this example, the resulting matrix shows where an element of A is equal to the corresponding element of B.

```
A = [2 7 6;9 0 5;3 0.5 6];  
B = [8 7 0;3 2 5;4 -1 7];  
A == B
```

```
ans =
```

```
0     1     0  
0     0     1  
0     0     0
```

For vectors and rectangular arrays, both operands must be the same size unless one is a scalar. For the case where one operand is a scalar and the other is not, MATLAB tests the scalar against every element of the other operand. Locations where the specified relation is true receive the value 1. Locations where the relation is false receive the value 0.

Relational Operators and Empty Arrays

The relational operators work with arrays for which any dimension has size zero, as long as both arrays are the same size or one is a scalar. However, expressions such as

```
A == []
```

return an error if A is not 0-by-0 or 1-by-1.

To test for empty arrays, use the function

```
isempty(A)
```

Logical Operators

This section describes the MATLAB logical operators and also covers:

- “Using Logical Operators on Arrays”
- “Logical Functions”
- “Logical Expressions Using the find Function”

MATLAB provides these logical operators.

Operator	Description
&	AND
	OR
~	NOT

Note In addition to these logical operators, the ops directory contains a number of functions that perform bitwise logical operations. See online help for more information.

Each logical operator has a specific set of rules that determines the result of a logical expression:

- An expression using the AND operator, `&`, is true if both operands are logically true. In numeric terms, the expression is true if both operands are nonzero. This example shows the logical AND of the elements in the vector `u` with the corresponding elements in the vector `v`.

```
u = [1 0 2 3 0 5];  
v = [5 6 1 0 0 7];
```

```
u & v
```

```
ans =
```

```
1 0 1 0 0 1
```

- An expression using the OR operator, `|`, is true if one operand is logically true, or if both operands are logically true. An OR expression is false only if both operands are false. In numeric terms, the expression is false only if both operands are zero. This example shows the logical OR of the elements in the vector `u` and with the corresponding elements in the vector `v`.

```
u | v
```

```
ans =
```

```
1 1 1 1 0 1
```

- An expression using the NOT operator, `~`, negates the operand. This produces a false result if the operand is true, and true if it is false. In numeric terms, any nonzero operand becomes zero, and any zero operand becomes one. This example shows the negation of the elements in the vector `u`.

```
~u
```

```
ans =
```

```
0 1 0 0 1 0
```

Using Logical Operators on Arrays

MATLAB's logical operators compare corresponding elements of arrays with equal dimensions. For vectors and rectangular arrays, both operands must be the same size unless one is a scalar. For the case where one operand is a scalar and the other is not, MATLAB tests the scalar against every element of the other operand. Locations where the specified relation is true receive the value 1. Locations where the relation is false receive the value 0.

Logical Functions

In addition to the logical operators, MATLAB provides a number of logical functions.

Function	Description	Examples
<code>xor</code>	Performs an exclusive OR on its operands. <code>xor</code> returns true if one operand is true and the other false. In numeric terms, the function returns 1 if one operand is nonzero and the other operand is zero.	<pre>a = 1; b = 1; xor(a,b) ans = 0</pre>
<code>all</code>	Returns 1 if all of the elements in a vector are true or nonzero. <code>all</code> operates columnwise on matrices.	<pre>A = [0 1 2;3 5 0] A = 0 1 2 3 5 0 all(A) ans = 0 1 0</pre>
<code>any</code>	Returns 1 if any of the elements of its argument are true or nonzero; otherwise, it returns 0. Like <code>all</code> , the <code>any</code> function operates columnwise on matrices.	<pre>v = [5 0 8]; any(v) ans = 1</pre>

A number of other MATLAB functions perform logical operations. For example, the `isnan` function returns 1 for NaNs; the `isinf` function returns 1 for Infs. See the `ops` directory for a complete listing of logical functions.

Logical Expressions Using the `find` Function

The `find` function determines the indices of array elements that meet a given logical condition. It's useful for creating masks and index matrices. In its most general form, `find` returns a single vector of indices. This vector can be used to index into arrays of any size or shape. For example,

```
A = magic(4)

A =

    16     2     3    13
     5    11    10     8
     9     7     6    12
     4    14    15     1
```

```
i = find(A > 8);
A(i) = 100
```

```
A =

   100     2     3   100
     5   100   100     8
   100     7     6   100
     4   100   100     1
```

You can also use `find` to obtain both the row and column indices for a rectangular matrix, as well as the array values that meet the logical condition. Use the `help` facility for more information on `find`.

Operator Precedence

You can build expressions that use any combination of arithmetic, relational, and logical operators. Precedence levels determine the order in which MATLAB evaluates an expression. Within each precedence level, operators have equal precedence and are evaluated from left to right. The precedence

rules for MATLAB operators are shown in this list, ordered from highest precedence level to lowest precedence level:

- 1 Parentheses ()
- 2 Transpose(. '), power(. ^), complex conjugate transpose(), matrix power(^)
- 3 Unary plus (+), unary minus (-), logical negation (-)
- 4 Multiplication (. *), right division (. /), left division(. \), matrix multiplication (*), matrix right division (/), matrix left division (\)
- 5 Addition (+), subtraction (-)
- 6 Colon operator (:)
- 7 Less than (<), less than or equal to (<=), greater than (>), greater than or equal to (>=), equal to (==), not equal to (~=)
- 8 Logical AND (&)
- 9 Logical OR (|)

Overriding Default Precedence

The default precedence can be overridden using parentheses, as shown in this example.

```
A = [3 9 5];
B = [2 1 5];
C = A./B.^2

C =
    0.7500    9.0000    0.2000

C = (A./B).^2

C =
    2.2500   81.0000    1.0000
```

Expressions can also include values that you access through subscripts.

```
b = sqrt(A(2)) + 2*B(1)
```

```
b =  
    7
```

Flow Control

There are eight flow control statements in MATLAB:

- `if`, together with `else` and `elseif`, executes a group of statements based on some logical condition.
- `switch`, together with `case` and `otherwise`, executes different groups of statements depending on the value of some logical condition.
- `while` executes a group of statements an indefinite number of times, based on some logical condition.
- `for` executes a group of statements a fixed number of times.
- `continue` passes control to the next iteration of a `for` or `while` loop, skipping any remaining statements in the body of the loop.
- `break` terminates execution of a `for` or `while` loop.
- `try...catch` changes flow control if an error is detected during execution.
- `return` causes execution to return to the invoking function.

All flow constructs use `end` to indicate the end of the flow control block.

Note You can often speed up the execution of MATLAB code by replacing `for` and `while` loops with vectorized code. See “Optimizing MATLAB Code” on page 17-71.

`if`, `else`, and `elseif`

`if` evaluates a logical expression and executes a group of statements based on the value of the expression. In its simplest form, its syntax is

```
if logical_expression
    statements
end
```

If the logical expression is true (1), MATLAB executes all the statements between the `if` and `end` lines. It resumes execution at the line following the `end` statement. If the condition is false (0), MATLAB skips all the statements between the `if` and `end` lines, and resumes execution at the line following the `end` statement.

For example,

```
if rem(a,2) == 0
    disp('a is even')
    b = a/2;
end
```

You can nest any number of `if` statements.

If the logical expression evaluates to a nonscalar value, all the elements of the argument must be nonzero. For example, assume `X` is a matrix. Then the statement

```
if X
    statements
end
```

is equivalent to

```
if all(X(:))
    statements
end
```

The `else` and `elseif` statements further conditionalize the `if` statement:

- The `else` statement has no logical condition. The statements associated with it execute if the preceding `if` (and possibly `elseif` condition) is false (0).
- The `elseif` statement has a logical condition that it evaluates if the preceding `if` (and possibly `elseif` condition) is false (0). The statements associated with it execute if its logical condition is true (1). You can have multiple `elseif`s within an `if` block.

```
if n < 0                % If n negative, display error message.
    disp('Input must be positive');
elseif rem(n,2) == 0 % If n positive and even, divide by 2.
    A = n/2;
else
    A = (n+1)/2;      % If n positive and odd, increment and divide.
end
```

if Statements and Empty Arrays

An if condition that reduces to an empty array represents a false condition. That is,

```
if A
    S1
else
    S0
end
```

will execute statement S0 when A is an empty array.

switch

switch executes certain statements based on the value of a variable or expression. Its basic form is

```
switch expression (scalar or string)
    case value1
        statements % Executes if expression is value1
    case value2
        statements % Executes if expression is value2
    .
    .
    .
    otherwise
        statements % Executes if expression does not
                    % does not match any case
end
```

This block consists of:

- The word `switch` followed by an expression to evaluate.
- Any number of case groups. These groups consist of the word `case` followed by a possible value for the expression, all on a single line. Subsequent lines contain the statements to execute for the given value of the expression. These can be any valid MATLAB statement including another `switch` block. Execution of a case group ends when MATLAB encounters the next case statement or the `otherwise` statement. Only the first matching case is executed.

- An optional `otherwise` group. This consists of the word `otherwise`, followed by the statements to execute if the expression's value is not handled by any of the preceding case groups. Execution of the `otherwise` group ends at the end statement.
- An end statement.

`switch` works by comparing the input expression to each case value. For numeric expressions, a case statement is true if `(value==expression)`. For string expressions, a case statement is true if `strcmp(value,expression)`.

The code below shows a simple example of the `switch` statement. It checks the variable `input_num` for certain values. If `input_num` is `-1`, `0`, or `1`, the case statements display the value on screen as text. If `input_num` is none of these values, execution drops to the `otherwise` statement and the code displays the text `'other value'`.

```
switch input_num
    case -1
        disp('negative one');
    case 0
        disp('zero');
    case 1
        disp('positive one');
    otherwise
        disp('other value');
end
```

Note For C Programmers unlike the C language `switch` construct, MATLAB's `switch` does not “fall through.” That is, if the first case statement is true, other case statements do not execute. Therefore, `break` statements are not used.

`switch` can handle multiple conditions in a single case statement by enclosing the case expression in a cell array.

```
switch var
  case 1
    disp('1')
  case {2,3,4}
    disp('2 or 3 or 4')
  case 5
    disp('5')
  otherwise
    disp('something else')
end
```

while

The while loop executes a statement or group of statements repeatedly as long as the controlling expression is true (1). Its syntax is

```
while expression
  statements
end
```

If the expression evaluates to a matrix, all its elements must be 1 for execution to continue. To reduce a matrix to a scalar value, use the all and any functions.

For example, this while loop finds the first integer n for which $n!$ (n factorial) is a 100-digit number.

```
n = 1;
while prod(1:n) < 1e100
  n = n + 1;
end
```

Exit a while loop at any time using the break statement.

while Statements and Empty Arrays

A while condition that reduces to an empty array represents a false condition. That is,

```
while A, S1, end
```

never executes statement S1 when A is an empty array.

for

The for loop executes a statement or group of statements a predetermined number of times. Its syntax is:

```
for index = start:increment:end
    statements
end
```

The default increment is 1. You can specify any increment, including a negative one. For positive indices, execution terminates when the value of the index exceeds the *end* value; for negative increments, it terminates when the index is less than the end value.

For example, this loop executes five times.

```
for i = 2:6
    x(i) = 2*x(i-1);
end
```

You can nest multiple for loops.

```
for i = 1:m
    for j = 1:n
        A(i,j) = 1/(i + j - 1);
    end
end
```

Note You can often speed up the execution of MATLAB code by replacing for and while loops with vectorized code. See “Vectorization of Loops” on page 1-91 for details.

Using Arrays as Indices

The index of a for loop can be an array. For example, consider an *m*-by-*n* array A. The statement

```
for i = A
    statements
end
```

sets i equal to the vector $A(:,k)$. For the first loop iteration, k is equal to 1; for the second k is equal to 2, and so on until k equals n . That is, the loop iterates for a number of times equal to the number of columns in A . For each iteration, i is a vector containing one of the columns of A .

continue

The `continue` statement passes control to the next iteration of the `for` or `while` loop in which it appears, skipping any remaining statements in the body of the loop. In nested loops, `continue` passes control to the next iteration of the `for` or `while` loop enclosing it.

The example below shows a `continue` loop that counts the lines of code in the file, `magic.m`, skipping all blank lines and comments. A `continue` statement is used to advance to the next line in `magic.m` without incrementing the count whenever a blank line or comment line is encountered.

```
fid = fopen('magic.m','r');
count = 0;
while ~feof(fid)
    line = fgetl(fid);
    if isempty(line) | strncmp(line,'% ',1)
        continue
    end
    count = count + 1;
end
disp(sprintf('%d lines',count));
```

break

The `break` statement terminates the execution of a `for` loop or `while` loop. When a `break` statement is encountered, execution continues with the next statement outside of the loop. In nested loops, `break` exits from the innermost loop only.

The example below shows a `while` loop that reads the contents of the file `fft.m` into a MATLAB character array. A `break` statement is used to exit the `while` loop when the first empty line is encountered. The resulting character array contains the M-file help for the `fft` program.

```
fid = fopen('fft.m','r');
s = '';
while ~feof(fid)
    line = fgetl(fid);
    if isempty(line)
        break
    end
    s = strvcat(s,line);
end
disp(s)
```

try ... catch

The general form of a try ... catch statement sequence is

```
try,
    statement,
    ...,
    statement,
catch,
    statement,
    ...,
    statement,
end
```

In this sequence the statements between try and catch are executed until an error occurs. The statements between catch and end are then executed. Use `lasterr` to see the cause of the error. If an error occurs between catch and end, MATLAB terminates execution unless another try ... catch sequence has been established.

return

`return` terminates the current sequence of commands and returns control to the invoking function or to the keyboard. `return` is also used to terminate keyboard mode. A called function normally transfers control to the function that invoked it when it reaches the end of the function. `return` may be inserted within the called function to force an early termination and to transfer control to the invoking function.

Subfunctions

Function M-files can contain code for more than one function. The first function in the file is the *primary function*, the function invoked with the M-file name. Additional functions within the file are *subfunctions* that are only visible to the primary function or other subfunctions in the same file.

Each subfunction begins with its own function definition line. The functions immediately follow each other. The various subfunctions can occur in any order, as long as the primary function appears first.

```
function [avg,med] = newstats(u) % Primary function
% NEWSTATS Find mean and median with internal functions.
n = length(u);
avg = mean(u,n);
med = median(u,n);

function a = mean(v,n)           % Subfunction
% Calculate average.
a = sum(v)/n;

function m = median(v,n)        % Subfunction
% Calculate median.
w = sort(v);
if rem(n,2) == 1
    m = w((n+1)/2);
else
    m = (w(n/2)+w(n/2+1))/2;
end
```

The subfunctions `mean` and `median` calculate the average and median of the input list. The primary function `newstats` determines the length of the list and calls the subfunctions, passing to them the list length `n`. Functions within the same M-file cannot access the same variables unless you declare them as global within the pertinent functions, or pass them as arguments. In addition, the help facility can only access the primary function in an M-file.

When you call a function from within an M-file, MATLAB first checks the file to see if the function is a subfunction. It then checks for a private function (described in the following section) with that name, and then for a standard M-file on your search path. Because it checks for a subfunction first, you can

supersede existing M-files using subfunctions with the same name, for example, `mean` in the above code. Function names must be unique within an M-file, however.

Private Functions

Private functions are functions that reside in subdirectories with the special name `private`. They are visible only to functions in the parent directory. For example, assume the directory `newmath` is on the MATLAB search path. A subdirectory of `newmath` called `private` can contain functions that only the functions in `newmath` can call. Because private functions are invisible outside of the parent directory, they can use the same names as functions in other directories. This is useful if you want to create your own version of a particular function while retaining the original in another directory. Because MATLAB looks for private functions before standard M-file functions, it will find a private function named `test.m` before a nonprivate M-file named `test.m`.

You can create your own private directories simply by creating subdirectories called `private` using the standard procedures for creating directories or folders on your computer. Do not place these private directories on your path.

Subscripting and Indexing

Subscripting

This section explains how to use subscripting to access and assign to elements of a MATLAB matrix. It covers the following:

- Accessing Single Elements of a Matrix
- Accessing Multiple Elements of a Matrix
- Expanding the Size of a Matrix
- Deleting Rows and Columns
- Concatenating Matrices

Accessing Single Elements of a Matrix

The element in row i and column j of A is denoted by $A(i,j)$. For example, suppose $A = \text{magic}(4)$. Then $A(4,2)$ is the number in the fourth row and second column. For our magic square, $A(4,2)$ is 14.

```
A = magic(4)
```

```
A =
```

```
    16     2     3    13
     5    11    10     8
     9     7     6    12
     4    14    15     1
```

```
A(4,2)
```

```
ans =
```

```
    14
```

It is also possible to refer to the elements of a matrix with a single subscript, $A(k)$. This is the usual way of referencing row and column vectors. But it can also apply to a fully two-dimensional matrix, in which case the array is regarded as one long column vector formed from the columns of the original matrix.

So, for our magic square, $A(8)$ is another way of referring to the value 14 stored in $A(4,2)$.

```
A(8)
```

```
ans =
```

```
14
```

Accessing Multiple Elements of a Matrix

It is possible to compute the sum of the elements in the fourth column of A by typing

```
A(1,4) + A(2,4) + A(3,4) + A(4,4)
```

You can reduce the size of this expression using the colon operator. Subscript expressions involving colons refer to portions of a matrix.

```
A(1:m,n)
```

refers to the elements in rows 1 through m of column n of the A matrix. Using this notation, you can compute the sum of the fourth column of A more succinctly.

```
sum(A(1:4,4))
```

The colon by itself refers to *all* the elements in a row or column of a matrix. The keyword `end` refers to the *last* row or column. Using the following syntax, you can compute this same column sum without having to specify row and column numbers.

```
sum(A(:,end))
```

```
ans =
```

```
34
```

By adding an additional colon operator, you can refer to nonconsecutive elements in a matrix. The $m:3:n$ in this expression means to make the assignment to every third element in the matrix.

```
B = A;  
B(1:3:end) = -10
```

```
B =  
  
-10     2     3    -10  
     5    11   -10     8  
     9   -10     6    12  
    -10    14    15   -10
```

You can repeatedly access an array element using the ones function. To create a new 2-by-6 matrix out of the the 9th element of A,

```
B = A(9*ones(2,6))
```

```
B =  
  
     3     3     3     3     3     3  
     3     3     3     3     3     3
```

Expanding the Size of a Matrix

If you try to access an element outside of the matrix, it is an error

```
B = A(4,5)  
Index exceeds matrix dimensions
```

However, if you store a value in an element outside of the matrix, the size of the matrix increases to accommodate the new element.

```
B = A;  
B(4,5) = 17  
  
B =  
  
    16     2     3    13     0  
     5    11    10     8     0  
     9     7     6    12     0  
     4    14    15     1    17
```

Similarly, you can expand a matrix by assigning to a series of matrix elements.

```
B(2:5,5:6) = 5
```

```
B =
```

```

16     2     3    13     0     0
 5    11    10     8     5     5
 9     7     6    12     5     5
 4    14    15     1     5     5
 0     0     0     0     5     5

```

Deleting Rows and Columns

You can delete rows and columns from a matrix using just a pair of square brackets. Start with

```
X = A;
```

Then, to delete the second column of X, use

```
X(:,2) = []
```

This changes X to

```

X =
16     3    13
 5    10     8
 9     6    12
 4    15     1

```

If you delete a single element from a matrix, the result isn't a matrix anymore. So expressions like

```
X(1,2) = []
```

result in an error. However, using a single subscript deletes a single element, or sequence of elements, and reshapes the remaining elements into a row vector. So

```
X(2:2:10) = []
```

results in

X =

16 9 3 6 13 12 1

Concatenating Matrices

Concatenation is the process of joining small matrices together to make bigger ones. In fact, you made your first matrix by concatenating its individual elements. The pair of square brackets, `[]`, is the concatenation operator. For an example, start with the 4-by-4 magic square, A, and form

```
B = [A A+32;A+48 A+16]
```

The result is an 8-by-8 matrix, obtained by joining the four submatrices.

B =

```
16 2 3 13 48 34 35 45
5 11 10 8 37 43 42 40
9 7 6 12 41 39 38 44
4 14 15 1 36 46 47 33
64 50 51 61 32 18 19 29
53 59 58 56 21 27 26 24
57 55 54 60 25 23 22 28
52 62 63 49 20 30 31 17
```

This matrix is half way to being another magic square. Its elements are a rearrangement of the integers 1:64. Its column sums are the correct value for an 8-by-8 magic square.

```
sum(B)
```

ans =

```
260 260 260 260 260 260 260 260
```

But, its row sums, `sum(B')'`, are not all the same. Further manipulation is necessary to make this a valid 8-by-8 magic square.

Advanced Indexing

MATLAB stores each array as a column of values regardless of the actual dimensions. This column consists of the array columns, appended end to end.

For example, MATLAB stores

$$A = [2 \ 6 \ 9; \ 4 \ 2 \ 8; \ 3 \ 0 \ 1]$$

as

```

2
4
3
6
2
0
9
8
1

```

Accessing A with a single subscript indexes directly into the storage column. $A(3)$ accesses the third value in the column, the number 3. $A(7)$ accesses the seventh value, 9, and so on.

If you supply more subscripts, MATLAB calculates an index into the storage column based on the dimensions you assigned to the array. For example, assume a two-dimensional array like A has size $[d1 \ d2]$, where $d1$ is the number of rows in the array and $d2$ is the number of columns. If you supply two subscripts (i, j) representing row-column indices, the offset is

$$(j-1)*d1+i$$

Given the expression $A(3, 2)$, MATLAB calculates the offset into A 's storage column as $(2-1)*3+3$, or 6. Counting down six elements in the column accesses the value 0.

Indexing Into Multidimensional Arrays

This storage and indexing scheme also extends to multidimensional arrays. In this case, MATLAB operates on a page-by-page basis to create the storage column, again appending elements columnwise.

For example, consider a 5-by-4-by-3-by-2 array C.

MATLAB displays C as

MATLAB stores C as

page(1,1) =

1	4	3	5
2	1	7	9
5	6	3	2
0	1	5	9
3	2	7	5

1
2
5
0
3

page(2,1) =

6	2	4	2
7	1	4	9
0	0	1	5
9	4	4	2
1	8	2	5

4
1
6
1
2
3
7
3
5
7
5

page(3,1) =

2	2	8	3
2	5	1	8
5	1	5	2
0	9	0	9
9	4	5	3

9
2
9
5
6
7
0
9
1
2
1

page(1,2) =

9	8	2	3
0	0	3	3
6	4	9	6
1	9	2	3
0	2	8	7

4
8
4
4
1
4
2

page(2,2) =

7	0	1	3
2	4	8	1
7	5	8	6
6	8	8	4
9	4	1	2

2
9
5
2
5
2
2
2
5
0
9

page(3,2) =

1	6	6	5
2	9	1	3
7	1	1	1
8	0	1	5
3	2	7	6

2
5
1
9
4
:

Again, a single subscript indexes directly into this column. For example, `C(4)` produces the result

```
ans =
     0
```

If you specify two subscripts (i, j) indicating row-column indices, MATLAB calculates the offset as described above. Two subscripts always access the first page of a multidimensional array, provided they are within the range of the original array dimensions.

If more than one subscript is present, all subscripts must conform to the original array dimensions. For example, `C(6, 2)` is invalid, because all pages of `C` have only five rows.

If you specify more than two subscripts, MATLAB extends its indexing scheme accordingly. For example, consider four subscripts (i, j, k, l) into a four-dimensional array with size $[d_1 \ d_2 \ d_3 \ d_4]$. MATLAB calculates the offset into the storage column by

$$(l-1)(d_3)(d_2)(d_1) + (k-1)(d_2)(d_1) + (j-1)(d_1) + i$$

For example, if you index the array `C` using subscripts $(3, 4, 2, 1)$, MATLAB returns the value 5 (index 38 in the storage column).

In general, the offset formula for an array with dimensions $[d_1 \ d_2 \ d_3 \ \dots \ d_n]$ using any subscripts $(s_1 \ s_2 \ s_3 \ \dots \ s_n)$ is

$$(s_n-1)(d_{n-1})(d_{n-2})\dots(d_1) + (s_{n-1}-1)(d_{n-2})\dots(d_1) + \dots + (s_2-1)(d_1) + s_1$$

Because of this scheme, you can index an array using any number of subscripts. You can append any number of 1s to the subscript list because these terms become zero. For example,

```
C(3, 2, 1, 1, 1, 1, 1, 1)
```

is equivalent to

```
C(3, 2)
```

String Evaluation

String evaluation adds power and flexibility to the MATLAB language, letting you perform operations like executing user-supplied strings and constructing executable strings through concatenation of strings stored in variables.

eval

The `eval` function evaluates a string that contains a MATLAB expression, statement, or function call. In its simplest form, the `eval` syntax is

```
eval('string')
```

For example, this code uses `eval` on an expression to generate a Hilbert matrix of order `n`.

```
t = '1/(i+j-1)';
for i = 1:n
    for j = 1:n
        a(i,j) = eval(t);
    end
end
```

Here's an example that uses `eval` on a statement.

```
eval('t = clock');
```

Constructing Strings for Evaluation

You can concatenate strings to create a complete expression for input to `eval`. This code shows how `eval` can create 10 variables named `P1`, `P2`, ...`P10`, and set each of them to a different value.

```
for i=1:10
    eval(['P',int2str(i),'= i.^2'])
end
```

feval

The `feval` function differs from `eval` in that it executes a function rather than a MATLAB expression. The function to be executed is specified in the first argument by either a function handle or a string containing the function name.

You can use `feval` and the `input` function to choose one of several tasks defined by M-files. This example uses function handles for the `sin`, `cos`, and `log` functions.

```
fun = [@sin; @cos; @log];
k = input('Choose function number: ');
x = input('Enter value: ');
feval(fun(k),x)
```

Note Use `feval` rather than `eval` whenever possible. M-files that use `feval` execute faster and can be compiled with the MATLAB Compiler.

Command/Function Duality

MATLAB commands are statements like

```
load
help
```

Many commands accept modifiers that specify operands.

```
load August17.dat
help magic
type rank
```

An alternate method of supplying the command modifiers makes them string arguments of functions.

```
load('August17.dat')
help('magic')
type('rank')
```

This is MATLAB's *command/function duality*. Any command of the form

```
command argument
```

can also be written in the functional form

```
command('argument')
```

The advantage of the functional approach comes when the string argument is constructed from other pieces. The following example processes multiple data files, August1.dat, August2.dat, and so on. It uses the function `int2str`, which converts an integer to a character string, to help build the filename.

```
for d = 1:31
    s = ['August' int2str(d) '.dat']
    load(s)
    % Process the contents of the d-th file
end
```

Empty Matrices

A matrix having at least one dimension equal to zero is called an *empty matrix*. The simplest empty matrix is 0-by-0 in size. Examples of more complex matrices are those of dimension 0-by-5 or 10-by-0-by-20.

To create a 0-by-0 matrix, use the square bracket operators with no value specified.

```
A = [];
```

```
whos A
  Name      Size      Bytes  Class
  A         0x0         0      double array
```

You can create empty arrays of other sizes using the `zeros`, `ones`, `rand`, or `eye` functions. To create a 0-by-5 matrix, for example, use

```
E = zeros(0,5)
```

Operating on an Empty Matrix

The basic model for empty matrices is that any operation that is defined for m -by- n matrices, and that produces a result whose dimension is some function of m and n , should still be allowed when m or n is zero. The size of the result should be that same function, evaluated at zero.

For example, horizontal concatenation

```
C = [A B]
```

requires that A and B have the same number of rows. So if A is m -by- n and B is m -by- p , then C is m -by- $(n+p)$. This is still true if m or n or p is zero.

Many operations in MATLAB produce row vectors or column vectors. It is possible for the result to be the empty row vector

```
r = zeros(1,0)
```

or the empty column vector

```
C = zeros(0,1)
```

As with all matrices in MATLAB, you must follow the rules concerning compatible dimensions. In the following example, an attempt to add a 1-by-3 matrix to a 0-by-3 empty matrix results in an error.

```
[1 2 3] + ones(0,3)

??? Error using ==> +
Matrix dimensions must agree.
```

Some MATLAB functions, like `sum` and `max`, are *reductions*. For matrix arguments, these functions produce vector results; for vector arguments they produce scalar results. Empty inputs produce the following results with these functions:

- `sum([])` is 0
- `prod([])` is 1
- `max([])` is []
- `min([])` is []

Using Empty Matrices with If or While

When the expression part of an `if` or `while` statement reduces to an empty matrix, MATLAB evaluates the expression as being `false`. The following example executes statement `S0`, because `A` is an empty array.

```
A = ones(25,0,4);

if A
    S1
else
    S0
end
```

Errors and Warnings

In many cases, it's desirable to take specific actions when different kinds of errors occur. For example, you may want to prompt the user for more input, display extended error or warning information, or repeat a calculation using default values. MATLAB's error handling capabilities let your application check for particular error conditions and execute appropriate code depending on the situation.

Error Handling with `eval` and `lasterr`

The basic tools for error-handling in MATLAB are:

- The `eval` function, which lets you execute a function and specify a second function to execute if an error occurs in the first.
- The `lasterr` function, which returns a string containing the last error generated by MATLAB.

The `eval` function provides error-handling capabilities using the two-argument form

```
eval ('trystring','catchstring')
```

If the operation specified by `trystring` executes properly, `eval` simply returns. If `trystring` generates an error, the function evaluates `catchstring`. Use `catchstring` to specify a function that determines the error generated by `trystring` and takes appropriate action.

The `trystring/catchstring` form of `eval` is especially useful in conjunction with the `lasterr` function. `lasterr` returns a string containing the last error message generated by MATLAB. Use `lasterr` inside the `catchstring` function to “catch” the error generated by `trystring`.

For example, this function uses `lasterr` to check for a specific error message that can occur during matrix multiplication. The error message indicates that matrix multiplication is impossible because the operands have different inner dimensions. If the message occurs, the code truncates one of the matrices to perform the multiplication.

```
function C = catchfcn(A,B)
l = lasterr;
j = findstr(l,'Inner matrix dimensions')
```

```
if (~isempty(j))
    [m,n] = size(A)
    [p,q] = size(B)
    if (n>p)
        A(:,p+1:n) = []
    elseif (n<p)
        B(n+1:p,:) = []
    end
    C = A*B;
else
    C = 0;
end
```

This example uses the two-argument form of `eval` with the `catchfcn` function shown above.

```
clear
A = [1 2 3; 6 7 2; 0 1 5];
B = [9 5 6; 0 4 9];
eval('A*B', 'catchfcn(A,B)')

A = 1:7;
B = randn(9,9);
eval('A*B', 'catchfcn(A,B)')
```

Displaying Error and Warning Messages

Use the `error` and `fprintf` functions to display error information on the screen. The `error` function has the syntax

```
error('error string')
```

If you call the `error` function from inside an M-file, `error` displays the text in the quoted string and causes the M-file to stop executing. For example, suppose the following appears inside the M-file `myfile.m`.

```
if n < 1
    error('n must be 1 or greater.')
end
```

For `n` equal to 0, the following text appears on the screen and the M-file stops.

```
??? Error using ==> myfile  
n must be 1 or greater.
```

In MATLAB, warnings are similar to error messages, except program execution does not stop. Use the `warning` function to display warning messages.

```
warning('warning string')
```

The function `lastwarn` displays the last warning message issued by MATLAB.

Dates and Times

MATLAB provides functions for time and date handling. These functions are in a directory called `timefun` in the MATLAB Toolbox.

Category	Function	Description
Current date and time	<code>clock</code>	Current date and time as date vector
	<code>date</code>	Current date as date string
	<code>now</code>	Current date and time as serial date number
Conversion	<code>datenum</code>	Convert to serial date number
	<code>datestr</code>	Convert to string representation of date
	<code>datevec</code>	Date components
Utility	<code>calendar</code>	Calendar
	<code>datetick</code>	Date formatted tick labels
	<code>eomday</code>	End of month
	<code>weekday</code>	Day of the week
Timing	<code>cputime</code>	CPU time in seconds
	<code>etime</code>	Elapsed time
	<code>tic, toc</code>	Stopwatch timer

Date Formats

This section covers the following topics:

- “Types of Date Formats”
- “Conversions Between Date Formats”
- “Date String Formats”
- “Output Formats”

Types of Date Formats

MATLAB works with three different date formats: date strings, serial date numbers, and date vectors.

When dealing with dates you typically work with date strings (16-Sep-1996). MATLAB works internally with *serial date numbers* (729284). A serial date represents a calendar date as the number of days that has passed since a fixed base date. In MATLAB, serial date number 1 is January 1, 0000. MATLAB also uses serial time to represent fractions of days beginning at midnight; for example, 6 p.m. equals 0.75 serial days. So the string '16-Sep-1996, 6:00 pm' in MATLAB is date number 729284.75.

All functions that require dates accept either date strings or serial date numbers. If you are dealing with a few dates at the MATLAB command-line level, date strings are more convenient. If you are using functions that handle large numbers of dates or doing extensive calculations with dates, you will get better performance if you use date numbers.

Date vectors are an internal format for some MATLAB functions; you do not typically use them in calculations. A date vector contains the elements [year month day hour minute second].

MATLAB provides functions that convert date strings to serial date numbers, and vice versa. Dates can also be converted to date vectors.

Here are examples of the three date formats used by MATLAB.

Date Format	Example
Date string	02-Oct-1996
Serial date number	729300
Date vector	1996 10 2 0 0 0

Conversions Between Date Formats

Functions that convert between date formats are shown below.

Function	Description
<code>datenum</code>	Convert date string to serial date number
<code>datestr</code>	Convert serial date number to date string
<code>datevec</code>	Split date number or date string into individual date elements

Here are some examples of conversions from one date format to another.

```
d1 = datenum('02-Oct-1996')
```

```
d1 =
```

```
729300
```

```
d2 = datestr(d1+10)
```

```
d2 =
```

```
12-Oct-1996
```

```
dv1 = datevec(d1)
```

```
dv1 =
```

```
1996      10      2      0      0      0
```

```
dv2 = datevec(d2)
```

```
dv2 =
```

```
1996      12      2      0      0      0
```

Date String Formats

The `datetime` function is important for doing date calculations efficiently. `datetime` takes an input string in any of several formats, with `'dd-mmm-yyyy'`, `'mm/dd/yyyy'`, or `'dd-mmm-yyyy, hh:mm:ss.ss'` most common. You can form up to six fields from letters and digits separated by any other characters:

- The day field is an integer from 1 to 31.
- The month field is either an integer from 1 to 12 or an alphabetic string with at least three characters.
- The year field is a non-negative integer: if only two digits are specified, then a year 19yy is assumed; if the year is omitted, then the current year is used as a default.
- The hours, minutes, and seconds fields are optional. They are integers separated by colons or followed by `'AM'` or `'PM'`.

For example, if the current year is 1996, then these are all equivalent

```
'17-May-1996'
'17-May-96'
'17-May'
'May 17, 1996'
'5/17/96'
'5/17'
```

and both of these represent the same time

```
'17-May-1996, 18:30'
'5/17/96/6:30 pm'
```

Note that the default format for numbers-only input follows the American convention. Thus `3/6` is March 6, not June 3.

If you create a vector of input date strings, use a column vector and be sure all strings are the same length. Fill in with spaces or zeros.

Output Formats

The function `datestr(D, dateform)` converts a serial date `D` to one of 19 different date string output formats showing date, time, or both. The default output for dates is a day-month-year string: `01-Mar-1996`. You select an alternative output format by using the optional integer argument `dateform`.

This table shows the date string formats that correspond to each dateform value.

dateform	Format	Description
0	01-Mar-1996 15:45:17	day-month-year hour:minute:second
1	01-Mar-1996	day-month-year
2	03/01/96	month/day/year
3	Mar	month, three letters
4	M	month, single letter
5	3	month
6	03/01	month/day
7	1	day of month
8	Wed	day of week, three letters
9	W	day of week, single letter
10	1996	year, four digits
11	96	year, two digits
12	Mar96	month year
13	15:45:17	hour:minute:second
14	03:45:17 PM	hour:minute:second AM or PM
15	15:45	hour:minute
16	03:45 PM	hour:minute AM or PM
17	Q1-96	calendar quarter-year
18	Q1	calendar quarter

Here are some examples of converting the date March 1, 1996 to various forms using the `datestr` function.

```
d = '01-Mar-1999'
```

```
d =
```

```
01-Mar-1999
```

```
datestr(d)
```

```
ans =
```

```
01-Mar-1999
```

```
datestr(d, 2)
```

```
ans =
```

```
03/01/99
```

```
datestr(d, 17)
```

```
ans =
```

```
Q1-99
```

Current Date and Time

The function `date` returns a string for today's date.

```
date
```

```
ans =
```

```
02-Oct-1996
```

The function `now` returns the serial date number for the current date and time.

```
now
```

```
ans =
```

```
729300.71
```

```
datestr(now)
```

```
ans =
```

```
02-Oct-1996 16:56:16
```

```
datestr(floor(now))
```

```
ans =
```

```
02-Oct-1996
```

Obtaining User Input

There are three ways to obtain input from a user during M-file execution. You can:

- Display a prompt and obtain keyboard input.
- Pause until the user presses a key.
- Build a complete graphical user interface.

This section covers the first two topics. The third topic is discussed in online documentation under “Creating Graphical User Interfaces”.

Prompting for Keyboard Input

The `input` function displays a prompt and waits for a user response. Its syntax is

```
n = input('prompt_string')
```

The function displays the *prompt_string*, waits for keyboard input, and then returns the value from the keyboard. If the user inputs an expression, the function evaluates it and returns its value. This function is useful for implementing menu-driven applications.

`input` can also return user input as a string, rather than a numeric value. To obtain string input, append 's' to the function's argument list.

```
name = input('Enter address: ', 's');
```

Pausing During Execution

Some M-files benefit from pauses between execution steps. For example, the `petals.m` script, shown in the “Simple Script Example” section, pauses between the plots it creates, allowing the user to display a plot for as long as desired and then press a key to move to the next plot.

The `pause` command, with no arguments, stops execution until the user presses a key. To pause for `n` seconds, use

```
pause(n)
```

Shell Escape Functions

It is sometimes useful to access your own C or Fortran programs using *shell escape functions*. Shell escape functions use the shell escape command `!` to make external stand-alone programs act like new MATLAB functions. A shell escape M-function is an M-file that:

- 1 Saves the appropriate variables on disk.
- 2 Runs an external program (which reads the data file, processes the data, and writes the results back out to disk).
- 3 Loads the processed file back into the workspace.

For example, look at the code for `garfield.m`, below. This function uses an external function, `gareqn`, to find the solution to Garfield's equation.

```
function y = garfield(a,b,q,r)
save gardata a b q r
!gareqn
load gardata
```

This M-file:

- 1 Saves the input arguments `a`, `b`, `q`, and `r` to a MAT-file in the workspace using the `save` command.
- 2 Uses the shell escape operator to access a C, or Fortran program called `gareqn` that uses the workspace variables to perform its computation. `gareqn` writes its results to the `gardata` MAT-file.
- 3 Loads the `gardata` MAT-file to obtain the results.

Optimizing MATLAB Code

This section describes techniques that often improve the execution speed and memory management of MATLAB code:

- Vectorizing loops
- Preallocating Arrays

MATLAB is a matrix language, which means it is designed for vector and matrix operations. For best performance, you should take advantage of this where possible.

For information on how to conserve memory and improve memory use, see the section, “Making Efficient Use of Memory” on page 17-74.

See “Improving M-File Performance - the Profiler” for information on using the MATLAB Profiler to identify which parts of your code consume the most time.

Vectorizing Loops

You can speed up your M-file code by vectorizing algorithms. *Vectorization* means converting `for` and `while` loops to equivalent vector or matrix operations.

A Simple Example

Here is one way to compute the sine of 1001 values ranging from 0 to 10.

```
i = 0;
for t = 0:.01:10
    i = i+1;
    y(i) = sin(t);
end
```

A vectorized version of the same code is:

```
t = 0:.01:10;
y = sin(t);
```

The second example executes much faster than the first and is the way MATLAB is meant to be used. Test this on your system by creating M-file scripts that contain the code shown, then using the `tic` and `toc` commands to time the M-files.

An Advanced Example

`repmat` is an example of a function that takes advantage of vectorization. It accepts three input arguments: an array `A`, a row dimension `M`, and a column dimension `N`.

`repmat` creates an output array that contains the elements of array `A`, replicated and “tiled” in an `M`-by-`N` arrangement.

```
A = [1 2 3; 4 5 6];  
B = repmat(A,2,3);
```

```
B =
```

```
     1     2     3     1     2     3     1     2     3  
     4     5     6     4     5     6     4     5     6  
     1     2     3     1     2     3     1     2     3  
     4     5     6     4     5     6     4     5     6
```

`repmat` uses vectorization to create the indices that place elements in the output array.

```
function B = repmat(A,M,N)  
if nargin < 2  
    error('Requires at least 2 inputs.')elseif nargin == 2  
    N = M;  
end  
  
% Step 1 Get row and column sizes  
[m,n] = size(A);  
  
% Step 2 Generate vectors of indices from 1 to row/column size  
mind = (1:m)';  
nind = (1:n)';  
  
% Step 3 Creates index matrices from vectors above  
mind = mind(:,ones(1,M));  
nind = nind(:,ones(1,N));  
  
% Step 4 Create output array  
B = A(mind,nind);
```

Step 1, above, obtains the row and column sizes of the input array.

Step 2 creates two column vectors. `mind` contains the integers from 1 through the row size of `A`. The `nind` variable contains the integers from 1 through the column size of `A`.

Step 3 uses a MATLAB vectorization trick to replicate a single column of data through any number of columns. The code is

```
B = A(:,ones(1,n_cols))
```

where `n_cols` is the desired number of columns in the resulting matrix.

Step 4 uses array indexing to create the output array. Each element of the row index array, `mind`, is paired with each element of the column index array, `nind`, using the following procedure:

- 1 The first element of `mind`, the row index, is paired with each element of `nind`. MATLAB moves through the `nind` matrix in a columnwise fashion, so `mind(1,1)` goes with `nind(1,1)`, then `nind(2,1)`, and so on. The result fills the first row of the output array.
- 2 Moving columnwise through `mind`, each element is paired with the elements of `nind` as above. Each complete pass through the `nind` matrix fills one row of the output array.

Preallocating Arrays

You can often improve code execution time by preallocating the arrays that store output results. Preallocation prevents MATLAB from having to resize an array each time you enlarge it. Use the appropriate preallocation function for the kind of array you are working with.

Array Type	Function	Examples
Numeric array	<code>zeros</code>	<code>y = zeros(1,100);</code>
Cell array	<code>cell</code>	<code>B = cell(2,3);</code> <code>B{1,3} = 1:3;</code> <code>B{2,2} = 'string';</code>

Array Type	Function	Examples
Structure array	struct, repmat	<code>data = repmat(struct('x',[1 3],... 'y',[5 6]), 1, 3);</code>

Preallocation also helps reduce memory fragmentation if you work with large matrices. In the course of a MATLAB session, memory can become fragmented due to dynamic memory allocation and deallocation. This can result in plenty of free memory, but not enough contiguous space to hold a large variable. Preallocation helps prevent this by allowing MATLAB to “grab” sufficient space for large data constructs at the beginning of a computation.

Making Efficient Use of Memory

This section discusses the following ways to conserve memory and improve memory use:

- “Memory Management Functions”
- “Removing a Function From Memory”
- “Nested Function Calls”
- “Variables and Memory”
- “PC-Specific Topics”
- “UNIX-Specific Topics”
- “What Does “Out of Memory” Mean?”

Memory Management Functions

MATLAB has five functions to improve how memory is handled:

- `clear` removes variables from memory.
- `pack` saves existing variables to disk, then reloads them contiguously. Because of time considerations, you should not use `pack` within loops or M-file functions.
- `quit` exits MATLAB and returns all allocated memory to the system.
- `save selectively` stores variables to disk.
- `load` reloads a data file saved with the `save` command.

Note `save` and `load` are faster than MATLAB low-level file I/O routines. `save` and `load` have been optimized to run faster and reduce memory fragmentation.

On some systems, the `whos` function displays the amount of free memory remaining. However, be aware that:

- If you delete a variable from the workspace, the amount of free memory indicated by `whos` usually does not get larger unless the deleted variable occupied the highest memory addresses. The number actually indicates the amount of contiguous, unused memory. Clearing the highest variable makes the number larger, but clearing a variable beneath the highest variable has no effect. This means that you might have more free memory than is indicated by `whos`.
- Computers with virtual memory do not display the amount of free memory remaining because neither MATLAB nor the hardware imposes limitations.

Removing a Function From Memory

MATLAB creates a list of M- and MEX-filenames at startup for all files that reside below the `matlab/toolbox` directories. This list is stored in memory and is freed only when a new list is created during a call to the `path` function. Function M-file code and MEX-file relocatable code are loaded into memory when the corresponding function is called. The M-file code or relocatable code is removed from memory when:

- The function is called again and a new version now exists.
- The function is explicitly cleared with the `clear` command.
- All functions are explicitly cleared with the `clear functions` command.
- MATLAB runs out of memory.

Nested Function Calls

The amount of memory used by nested functions is the same as the amount used by calling them on consecutive lines. These two examples require the same amount of memory.

```
result = function2(function1(input99));  
  
result = function1(input99);  
result = function2(result);
```

Variables and Memory

Memory is allocated for variables whenever the left-hand side variable in an assignment does not exist. The statement

```
x = 10
```

allocates memory, but the statement

```
x(10) = 1
```

does not allocate memory if the 10th element of `x` exists.

To conserve memory:

- Avoid creating large temporary variables, and clear temporary variables when they are no longer needed.
- When working with arrays of fixed size, pre-allocate them rather than having MATLAB resize the array each time you enlarge it.
- Set variables equal to the empty matrix `[]` to free memory, or clear them using

```
clear variable_name
```

- Reuse variables as much as possible.

Global Variables. Declaring variables as `global` merely puts a flag in a symbol table. It does not use any more memory than defining nonglobal variables. Consider the following example.

```
global a  
a = 5;
```

Now there is one copy of `a` stored in the MATLAB workspace. Typing

```
clear a
```

removes `a` from the MATLAB workspace, but it still exists in the global workspace.

```
clear global a
```

removes `a` from the global workspace.

PC-Specific Topics

- There are no functions implemented to manipulate the way MATLAB handles Microsoft Windows system resources. Windows uses system resources to track fonts, windows, and screen objects. Resources can be depleted by using multiple figure windows, multiple fonts, or several Uicontrols. The best way to free up system resources is to close all inactive windows. Iconified windows still use resources.
- The performance of a permanent swap file is typically better than a temporary swap file.
- Typically a swap file twice the size of the installed RAM is sufficient.

UNIX-Specific Topics

- Memory that MATLAB requests from the operating system is not returned to the operating system until the MATLAB process is finished.
- MATLAB requests memory from the operating system when there is not enough memory available in the MATLAB heap to store the current variables. It reuses memory in the heap as long as the size of the memory segment required is available in the MATLAB heap.

For example, on one machine these statements use approximately 15.4 MB of RAM.

```
a = rand(1e6,1);  
b = rand(1e6,1);
```

These statements use approximately 16.4 MB of RAM.

```
c = rand(2.1e6,1);
```

These statements use approximately 32.4 MB of RAM.

```
a = rand(1e6,1);  
b = rand(1e6,1);  
clear
```

```
c = rand(2.1e6,1);
```

This is because MATLAB is not able to fit a 2.1 MB array in the space previously occupied by two 1 MB arrays. The simplest way to prevent overallocation of memory, is to preallocate the largest vector. This series of statements uses approximately 32.4 MB of RAM

```
a = rand(1e6,1);  
b = rand(1e6,1);  
clear  
c = rand(2.1e6,1);
```

while these statements use only about 16.4 MB of RAM

```
c = rand(2.1e6,1);  
clear  
a = rand(1e6,1);  
b = rand(1e6,1);
```

Allocating the largest vectors first allows for optimal use of the available memory.

What Does “Out of Memory” Mean?

Typically the Out of Memory message appears because MATLAB asked the operating system for a segment of memory larger than what is currently available. Use any of the techniques discussed in this section to help optimize the available memory. If the Out of Memory message still appears:

- Increase the size of the swap file.
- Make sure that there are no external constraints on the memory accessible to MATLAB (on UNIX systems use the limit command to check).
- Add more memory to the system.
- Reduce the size of your data.

Character Arrays (Strings)

Character Arrays	18-5
Creating Character Arrays	18-5
Creating Two-Dimensional Character Arrays	18-6
Converting Characters to Numeric Values	18-7
Cell Arrays of Strings	18-8
Converting to a Cell Array of Strings	18-8
String Comparisons	18-10
Comparing Strings For Equality	18-10
Comparing for Equality Using Operators	18-11
Categorizing Characters Within a String	18-12
Searching and Replacing	18-13
String/Numeric Conversion	18-15
Array/String Conversion	18-16

This chapter explains MATLAB's support for string data. It describes the two ways that MATLAB represents strings:

- “Character Arrays”
- “Cell Arrays of Strings”

It also describes the operations that you can perform on string data under the following topics:

- “String Comparisons”
- “Searching and Replacing”
- “String/Numeric Conversion”

This table shows the string functions, which are located in the directory named `strfun` in the MATLAB Toolbox.

Category	Function	Description
General	<code>blanks</code>	String of blanks
	<code>cellstr</code>	Create cell array of strings from character array
	<code>char</code>	Create character array (string)
	<code>deblank</code>	Remove trailing blanks
	<code>eval</code>	Execute string with MATLAB expression
String Tests	<code>iscellstr</code>	True for cell array of strings
	<code>ischar</code>	True for character array
	<code>isletter</code>	True for letters of alphabet.
	<code>isspace</code>	True for whitespace characters.

Category	Function	Description
String Operations	findstr	Find one string within another
	lower	Convert string to lowercase
	strcat	Concatenate strings
	strcmp	Compare strings
	strcmpi	Compare strings, ignoring case
	strjust	Justify string
	strmatch	Find matches for string
	strncmp	Compare first N characters of strings
	strncmpi	Compare first N characters, ignoring case
	strep	Replace string with another
	strtok	Find token in string
	strvcat	Concatenate strings vertically
	upper	Convert string to uppercase
String to Number Conversion	double	Convert string to numeric codes
	int2str	Convert integer to string
	mat2str	Convert matrix to eval'able string
	num2str	Convert number to string
	sprintf	Write formatted data to string
	str2double	Convert string to double-precision value
	str2num	Convert string to number
	sscanf	Read string under format control

Category	Function	Description
Base Number Conversion	base2dec	Convert base B string to decimal integer
	bin2dec	Convert binary string to decimal integer
	dec2base	Convert decimal integer to base B string
	dec2bin	Convert decimal integer to binary string
	dec2hex	Convert decimal integer to hexadecimal string
	hex2dec	Convert hexadecimal string to decimal integer
	hex2num	Convert IEEE hexadecimal to double-precision number

Character Arrays

In MATLAB, the term *string* refers to an array of characters. MATLAB represents each character internally as its corresponding numeric value. Unless you want to access these values, however, you can simply work with the characters as they display on screen.

This section covers:

- “Creating Character Arrays”
- “Creating Two-Dimensional Character Arrays”
- “Converting Characters to Numeric Values”

Creating Character Arrays

Specify character data by placing characters inside a pair of single quotes. For example, this line creates a 1-by-13 character array called `name`.

```
name = 'Thomas R. Lee';
```

In the workspace, the output of `whos` shows

Name	Size	Bytes	Class
name	1x13	26	char array

You can see that a character uses two bytes of storage internally.

The `class` and `ischar` functions show `name`'s identity as a character array.

```
class(name)

ans =

char

ischar(name)

ans =

1
```

You can also join two or more character arrays together to create a new character array. Use either the string concatenation function, `strcat`, or the MATLAB concatenation operator, `[]`, to do this. The latter preserves any trailing spaces found in the input arrays.

```
name = 'Thomas R. Lee';
title = ' Sr. Developer';
strcat(name, ',', title)

ans =

Thomas R. Lee, Sr. Developer
```

You can also concatenate strings vertically with `strvcat`.

Creating Two-Dimensional Character Arrays

When creating a two-dimensional character array, be sure that each row has the same length. For example, this line is legal because both input rows have exactly 13 characters.

```
name = ['Thomas R. Lee' ; 'Sr. Developer']

name =

Thomas R. Lee
Sr. Developer
```

When creating character arrays from strings of different lengths, you can pad the shorter strings with blanks to force rows of equal length.

```
name = ['Thomas R. Lee   '; 'Senior Developer'];
```

A simpler way to create string arrays is to use the `char` function. `char` automatically pads all strings to the length of the longest input string. In this example, `char` pads the 13-character input string 'Thomas R. Lee' with three trailing blanks so that it will be as long as the second string.

```
name = char('Thomas R. Lee', 'Senior Developer')

name =

Thomas R. Lee
```

```
Senior Developer
```

When extracting strings from an array, use the `deblank` function to remove any trailing blanks.

```
trimname = deblank(name(1,:))  
  
trimname =  
  
Thomas R. Lee  
  
size(trimname)  
  
ans =  
  
1    13
```

Converting Characters to Numeric Values

Character arrays store each character as a 16-bit numeric value. Use the `double` function to convert strings to their numeric values, and `char` to revert to character representation.

```
name = double(name)  
  
name =  
  
84 104 111 109 97 115 32 82 46 32 76 101 101  
  
name = char(name)  
name =  
  
Thomas R. Lee
```

Use `str2num` to convert a character array to the numeric value represented by that string.

```
str = '37.294e-1';  
val = str2num(str)  
  
val =  
3.7294
```

Cell Arrays of Strings

It's often convenient to store groups of strings in cell arrays instead of standard character arrays. This prevents you from having to pad strings with blanks to create character arrays with rows of equal length. A set of functions enables you to work with cell arrays of strings:

- You can convert between standard character arrays and cell arrays of strings.
- You can apply string comparison operations to cell arrays of strings.

For details on cell arrays see the “Structures and Cell Arrays” chapter.

Converting to a Cell Array of Strings

The `cellstr` function converts a character array into a cell array of strings. Consider the character array

```
data = ['Allison Jones'; 'Development  '; 'Phoenix      '];
```

Each row of the matrix is padded so that all have equal length (in this case, 13 characters).

Now use `cellstr` to create a column vector of cells, each cell containing one of the strings from the data array.

```
celldata = cellstr(data)
```

```
celldata =  
  
    'Allison Jones'  
    'Development '  
    'Phoenix'
```

Note that the `cellstr` function strips off the blanks that pad the rows of the input string matrix.

```
length(celldata{3})
```

```
ans =
```

```
7
```

The `iscellstr` function determines if the input argument is a cell array of strings. It returns a logical true (1) in the case of `celldata`.

```
iscellstr(celldata)
```

```
ans =
```

```
1
```

Use `char` to convert back to a standard padded character array.

```
strings = char(celldata)
```

```
strings =
```

```
Allison Jones  
Development  
Phoenix
```

String/Numeric Conversion

The `str2double` function converts a cell array of strings to the double-precision values represented by the strings.

```
c = {'37.294e-1'; '-58.375'; '13.796'};  
str2double(c)
```

```
ans =
```

```
3.7294  
-58.3750  
13.7960
```

String Comparisons

There are several ways to compare strings and substrings:

- You can compare two strings, or parts of two strings, for equality.
- You can compare individual characters in two strings for equality.
- You can categorize every element within a string, determining whether each element is a character or whitespace.

These functions work for both character arrays and cell arrays of strings.

Comparing Strings For Equality

There are four functions that determine if two input strings are identical:

- `strcmp` determines if two strings are identical.
- `strncmp` determines if the first `n` characters of two strings are identical.
- `strcmpi` and `strncmpi` are the same as `strcmp` and `strncmp`, except that they ignore case.

Consider the two strings

```
str1 = 'hello';  
str2 = 'help';
```

Strings `str1` and `str2` are not identical, so invoking `strcmp` returns 0 (false).
For example,

```
C = strcmp(str1, str2)  
  
C =  
  
0
```

Note For C programmers, this is an important difference between MATLAB's `strcmp` and C's `strcmp()`, which returns 0 if the two strings are the same.

The first three characters of `str1` and `str2` are identical, so invoking `strncmp` with any value up to 3 returns 1.

```
C = strncmp(str1,str2,2)
```

```
C =
```

```
1
```

These functions work cell-by-cell on a cell array of strings. Consider the two cell arrays of strings

```
A = {'pizza'; 'chips'; 'candy'};
```

```
B = {'pizza'; 'chocolate'; 'pretzels'};
```

Now apply the string comparison functions.

```
strcmp(A,B)
```

```
ans =
```

```
1
```

```
0
```

```
0
```

```
strncmp(A,B,1)
```

```
ans =
```

```
1
```

```
1
```

```
0
```

Comparing for Equality Using Operators

You can use MATLAB relational operators on character arrays, as long as the arrays you are comparing have equal dimensions, or one is a scalar. For example, you can use the equality operator (`==`) to determine which characters in two strings match.

```
A = 'fate';  
B = 'cake';  
A == B  
  
ans =  
  
    0    1    0    1
```

All of the relational operators (>, >=, <, <=, ==, !=) compare the values of corresponding characters.

Categorizing Characters Within a String

There are two functions for categorizing characters inside a string:

- `isletter` determines if a character is a letter
- `isspace` determines if a character is whitespace (blank, tab, or new line)

For example, create a string named `mystring`.

```
mystring = 'Room 401';
```

`isletter` examines each character in the string, producing an output vector of the same length as `mystring`.

```
A = isletter(mystring)  
  
A =  
  
    1    1    1    1    0    0    0    0
```

The first four elements in `A` are 1 (true) because the first four characters of `mystring` are letters.

Searching and Replacing

MATLAB provides several functions for searching and replacing characters in a string. Consider a string named `label`.

```
label = 'Sample 1, 10/28/95';
```

The `strrep` function performs the standard search-and-replace operation. Use `strrep` to change the date from '10/28' to '10/30'.

```
newlabel = strrep(label,'28','30')
```

```
newlabel =
```

```
Sample 1, 10/30/95
```

`findstr` returns the starting position of a substring within a longer string. To find all occurrences of the string 'amp' inside `label`

```
position = findstr('amp',label)
```

```
position =
```

```
2
```

The position within `label` where the only occurrence of 'amp' begins is the second character.

The `strtok` function returns the characters before the first occurrence of a delimiting character in an input string. The default delimiting characters are the set of whitespace characters. You can use the `strtok` function to parse a sentence into words; for example,

```
function all_words = words(input_string)
```

```
remainder = input_string;
```

```
all_words = '';
```

```
while (any(remainder))
```

```
    [chopped,remainder] = strtok(remainder);
```

```
    all_words = strvcat(all_words,chopped);
```

```
end
```

The `strmatch` function looks through the rows of a character array or cell array of strings to find strings that begin with a given series of characters. It returns the indices of the rows that begin with these characters.

```
maxstrings = strvcat('max','minimax','maximum')
```

```
maxstrings =
```

```
max  
minimax  
maximum
```

```
strmatch('max',maxstrings)
```

```
ans =
```

```
1  
3
```

String/Numeric Conversion

MATLAB's string/numeric conversion functions change numeric values into character strings. You can store numeric values as digit-by-digit string representations, or convert a value into a hexadecimal or binary string. Consider a the scalar

```
x = 5317;
```

By default, MATLAB stores the number `x` as a 1-by-1 double array containing the value 5317. The `int2str` (integer to string) function breaks this scalar into a 1-by-4 vector containing the string '5317'.

```
y = int2str(x);  
size(y)
```

```
ans =
```

```
1     4
```

A related function, `num2str`, provides more control over the format of the output string. An optional second argument sets the number of digits in the output string, or specifies an actual format.

```
p = num2str(pi,9)
```

```
p =
```

```
3.14159265
```

Both `int2str` and `num2str` are handy for labeling plots. For example, the following lines use `num2str` to prepare automated labels for the `x`-axis of a plot.

```
function plotlabel(x,y)  
plot(x,y)  
str1 = num2str(min(x));  
str2 = num2str(max(x));  
out = ['Value of f from ' str1 ' to ' str2];  
xlabel(out);
```

Another class of numeric/string conversion functions changes numeric values into strings representing a decimal value in another base, such as binary or

hexadecimal representation. For example, the `dec2hex` function converts a decimal value into the corresponding hexadecimal string.

```
dec_num = 4035;
hex_num = dec2hex(dec_num)

hex_num =

FC3
```

See the `strfun` directory for a complete listing of string conversion functions.

Array/String Conversion

The MATLAB function `mat2str` changes an array to a string that MATLAB can evaluate. This string is useful input for a function such as `eval`, which evaluates input strings just as if they were typed at the MATLAB command line.

Create a 2-by-3 array A.

```
A = [1 2 3; 4 5 6]

A =

     1     2     3
     4     5     6
```

`mat2str` returns a string that contains the text you would enter to create A at the command line.

```
B = mat2str(A)

B =

[1 2 3; 4 5 6]
```

Multidimensional Arrays

Multidimensional Arrays	19-3
Creating Multidimensional Arrays	19-4
Accessing Multidimensional Array Properties	19-8
Indexing	19-9
Reshaping	19-10
Permuting Array Dimensions	19-12
Computing with Multidimensional Arrays	19-14
Operating on Vectors	19-14
Operating Element-by-Element	19-14
Operating on Planes and Matrices	19-15
Organizing Data in Multidimensional Arrays	19-16
Multidimensional Cell Arrays	19-18
Multidimensional Structure Arrays	19-19
Applying Functions to Multidimensional Structure Arrays	19-20

This chapter discusses *multidimensional arrays*, MATLAB arrays with more than two dimensions. Multidimensional arrays can be numeric, character, cell, or structure arrays. These arrays are broadly useful—for example, in the representation of multivariate data, or multiple pages of two-dimensional data.

This chapter covers the following topics:

- “Multidimensional Arrays”
- “Computing with Multidimensional Arrays”
- “Organizing Data in Multidimensional Arrays”
- “Multidimensional Cell Arrays”
- “Multidimensional Structure Arrays”

MATLAB provides a number of functions that directly support multidimensional arrays. You can extend this support by creating M-files that work with your data architecture.

Function	Description
cat	Concatenate arrays.
ipermute	Inverse permute array dimensions.
ndgrid	Generate arrays for N-D functions and interpolation.
ndims	Number of array dimensions.
permute	Permute array dimensions.
shiftdim	Shift dimensions.
squeeze	Remove singleton dimensions.

Multidimensional Arrays

Multidimensional arrays in MATLAB are an extension of the normal two-dimensional matrix. Matrices have two dimensions: the row dimension and the column dimension.

		column			
		→			
row	↓	(1,1)	(1,2)	(1,3)	(1,4)
	(2,1)	(2,2)	(2,3)	(2,4)	
	(3,1)	(3,2)	(3,3)	(3,4)	
	(4,1)	(4,2)	(4,3)	(4,4)	

You can access a two-dimensional matrix element with two subscripts: the first representing the row index, and the second representing the column index.

Multidimensional arrays use additional subscripts for indexing. A three-dimensional array, for example, uses three subscripts:

- The first references array dimension 1, the row.
- The second references dimension 2, the column.
- The third references dimension 3. This guide uses the concept of a *page* to represent dimensions 3 and higher.

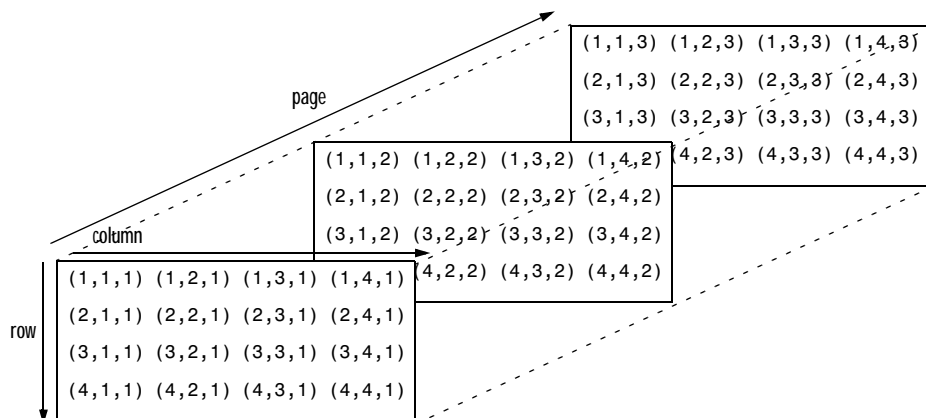

To access the element in the second row, third column of page 2, for example, you use the subscripts (2,3,2).

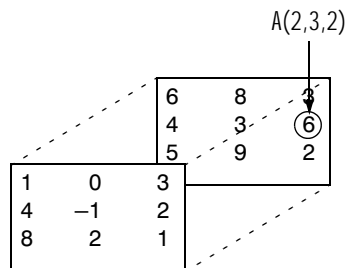

$$A(:, :, 1) =$$

1	0	3
4	-1	2
8	2	1

$$A(:, :, 2) =$$

6	8	3
4	3	6
5	9	2

As you add dimensions to an array, you also add subscripts. A four-dimensional array, for example, has four subscripts. The first two reference a row-column pair; the second two access the third and fourth dimensions of data.

Note The general multidimensional array functions reside in the `datatypes` directory.

Creating Multidimensional Arrays

You can use the same techniques to create multidimensional arrays that you use for two-dimensional matrices. In addition, MATLAB provides a special concatenation function that is useful for building multidimensional arrays.

This section discusses:

- Generating arrays using indexing
- Generating arrays using MATLAB functions
- Using the `cat` function to build multidimensional arrays

Generating Arrays Using Indexing

One way to create a multidimensional array is to create a two-dimensional array and extend it. For example, begin with a simple two-dimensional array `A`.

```
A = [5 7 8; 0 1 9; 4 3 6];
```

A is a 3-by-3 array, that is, its row dimension is 3 and its column dimension is 3. To add a third dimension to A,

```
A(:,:,2) = [1 0 4; 3 5 6; 9 8 7]
```

MATLAB responds with

```
A(:,:,1) =
```

```

5     7     8
0     1     9
4     3     6
```

```
A(:,:,2) =
```

```

1     0     4
3     5     6
9     8     7
```

You can continue to add rows, columns, or pages to the array using similar assignment statements.

Extending Multidimensional Arrays. To extend A in any dimension:

- Increment or add the appropriate subscript and assign the desired values.
- Assign the same number of elements to corresponding array dimensions. For numeric arrays, all rows must have the same number of elements, all pages must have the same number of rows and columns, and so on.

You can take advantage of MATLAB's scalar expansion capabilities, together with the colon operator, to fill an entire dimension with a single value.

```
A(:,:,3) = 5;
```

```
A(:,:,3)
```

```
ans =
```

```

5     5     5
5     5     5
5     5     5
```

To turn A into a 3-by-3-by-3-by-2, four-dimensional array, enter

```
A(:,:,1,2) = [1 2 3; 4 5 6; 7 8 9];  
A(:,:,2,2) = [9 8 7; 6 5 4; 3 2 1];  
A(:,:,3,2) = [1 0 1; 1 1 0; 0 1 1];
```

Note that after the first two assignments MATLAB pads A with zeros, as needed, to maintain the corresponding sizes of dimensions.

Generating Arrays Using MATLAB Functions

You can use MATLAB functions such as `randn`, `ones`, and `zeros` to generate multidimensional arrays in the same way you use them for two-dimensional arrays. Each argument you supply represents the size of the corresponding dimension in the resulting array. For example, to create a 4-by-3-by-2 array of normally distributed random numbers.

```
B = randn(4,3,2)
```

To generate an array filled with a single constant value, use the `repmat` function. `repmat` replicates an array (in this case, a 1-by-1 array) through a vector of array dimensions.

```
B = repmat(5,[3 4 2])
```

```
B(:,:,1) =
```

```
    5    5    5    5  
    5    5    5    5  
    5    5    5    5
```

```
B(:,:,2) =
```

```
    5    5    5    5  
    5    5    5    5  
    5    5    5    5
```

Note Any dimension of an array can have size zero, making it a form of empty array. For example, 10-by-0-by-20 is a valid size for a multidimensional array.

Building Multidimensional Arrays with the cat Function

The `cat` function is a simple way to build multidimensional arrays; it concatenates a list of arrays along a specified dimension.

```
B = cat(dim,A1,A2...)
```

where `A1`, `A2`, and so on are the arrays to concatenate, and `dim` is the dimension along which to concatenate the arrays. For example, to create a new array with `cat`

```
B = cat(3,[2 8; 0 5],[1 3; 7 9])
```

```
B(:, :, 1) =
```

```
    2    8
    0    5
```

```
B(:, :, 2) =
```

```
    1    3
    7    9
```

The `cat` function accepts any combination of existing and new data. In addition, you can nest calls to `cat`. The lines below, for example, create a four-dimensional array.

```
A = cat(3,[9 2; 6 5],[7 1; 8 4])
B = cat(3,[3 5; 0 1],[5 6; 2 1])
D = cat(4,A,B,cat(3,[1 2; 3 4],[4 3;2 1]))
```

`cat` automatically adds subscripts of 1 between dimensions, if necessary. For example, to create a 2-by-2-by-1-by-2 array, enter

```
C = cat(4,[1 2; 4 5],[7 8; 3 2])
```

In the previous case, `cat` inserts as many singleton dimensions as needed to create a four-dimensional array whose last dimension is not a singleton dimension. If the `dim` argument had been 5, the previous statement would have produced a 2-by-2-by-1-by-1-by-2 array. This adds additional 1s to indexing

expressions for the array. To access the value 8 in the four-dimensional case, use

```
C(1,2,1,2)
      ↑
Singleton dimension
index
```

Accessing Multidimensional Array Properties

You can use the following MATLAB functions to get information about multidimensional arrays you have created.

Information	Function	Example
Array size	size	<pre>size(C) ans = 2 2 1 2 rows columns dim3 dim4</pre>
Array dimensions	ndims	<pre>ndims(C) ans = 4</pre>
Array storage and format	whos	<pre>whos Name Size Bytes Class A 2x2x2 64 double array B 2x2x2 64 double array C 4-D 64 double array D 4-D 192 double array Grand total is 48 elements using 384 bytes</pre>

Indexing

Many of the concepts that apply to two-dimensional matrices extend to multidimensional arrays as well.

To access a single element of a multidimensional array, use integer subscripts. Each subscript indexes a dimension—the first indexes the row dimension, the second indexes the column dimension, the third indexes the first page dimension, and so on.

Consider a 10-by-5-by-3 array `nddata` of random integers:

```
nddata = fix(8*randn(10,5,3));
```

To access element (3,2) on page 2 of `nddata`, for example, use `nddata(3,2,2)`.

You can use vectors as array subscripts. In this case, each vector element must be a valid subscript, that is, within the bounds defined by the dimensions of the array. To access elements (2,1), (2,3), and (2,4) on page 3 of `nddata`, use

```
nddata(2,[1 3 4],3);
```

The Colon and Multidimensional Array Indexing

MATLAB's colon indexing extends to multidimensional arrays. For example, to access the entire third column on page 2 of `nddata`, use `nddata(:,3,2)`.

The colon operator is also useful for accessing other subsets of data. For example, `nddata(2:3,2:3,1)` results in a 2-by-2 array, a subset of the data on page 1 of `nddata`. This matrix consists of the data in rows 2 and 3, columns 2 and 3, on the first page of the array.

The colon operator can appear as an array subscript on both sides of an assignment statement. For example, to create a 4-by-4 array of zeros

```
C = zeros(4,4)
```

Now assign a 2-by-2 subset of array `nddata` to the four elements in the center of `C`.

```
C(2:3,2:3) = nddata(2:3,1:2,2)
```

Avoiding Ambiguity in Multidimensional Indexing

Some assignment statements, such as

```
A(:, :, 2) = 1:10
```

are ambiguous because they do not provide enough information about the shape of the dimension to receive the data. In the case above, the statement tries to assign a one-dimensional vector to a two-dimensional destination. MATLAB produces an error for such cases. To resolve the ambiguity, be sure you provide enough information about the destination for the assigned data, and that both data and destination have the same shape. For example,

```
A(1, :, 2) = 1:10;
```

Reshaping

Unless you change its shape or size, a MATLAB array retains the dimensions specified at its creation. You change array size by adding or deleting elements. You change array shape by respecifying the array's row, column, or page dimensions while retaining the same elements. The reshape function performs the latter operation. For multidimensional arrays, its form is

```
B = reshape(A, [s1 s2 s3 ...])
```

s1, s2, and so on represent the desired size for each dimension of the reshaped matrix. Note that a reshaped array must have the same number of elements as the original array (that is, the product of the dimension sizes is constant).

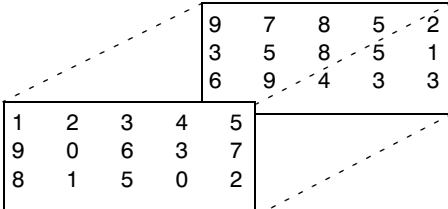
M	reshape(M, [6 5])
 <pre> 9 7 8 5 2 3 5 8 5 1 6 9 4 3 3 1 2 3 4 5 9 0 6 3 7 8 1 5 0 2 </pre>	<pre> 1 3 5 7 5 9 6 7 5 5 8 5 2 9 3 2 4 9 8 2 0 3 3 8 1 1 0 6 4 3 </pre>

The reshape function operates in a columnwise manner. It creates the reshaped matrix by taking consecutive elements down each column of the original data construct.

C	reshape(C, [6 2])												
	<table border="1" style="margin-left: auto; margin-right: auto;"> <tr><td>1</td><td>6</td></tr> <tr><td>3</td><td>8</td></tr> <tr><td>2</td><td>9</td></tr> <tr><td>4</td><td>11</td></tr> <tr><td>5</td><td>10</td></tr> <tr><td>7</td><td>12</td></tr> </table>	1	6	3	8	2	9	4	11	5	10	7	12
1	6												
3	8												
2	9												
4	11												
5	10												
7	12												

Here are several new arrays from reshaping nddata.

```
B = reshape(nddata,[6 25])
C = reshape(nddata,[5 3 10])
D = reshape(nddata,[5 3 2 5])
```

Removing Singleton Dimensions

MATLAB creates singleton dimensions if you explicitly specify them when you create or reshape an array, or if you perform a calculation that results in an array dimension of one.

```
B = repmat(5,[2 3 1 4]);
size(B)
```

```
ans =
```

```
2     3     1     4
```

The squeeze function removes singleton dimensions from an array.

```
C = squeeze(B);
size(C)
```

```
ans =
```

```
2     3     4
```

The squeeze function does not affect two-dimensional arrays; row vectors remain rows.

Permuting Array Dimensions

The permute function reorders the dimensions of an array.

```
B = permute(A,dims);
```

`dims` is a vector specifying the new order for the dimensions of `A`, where 1 corresponds to the first dimension (rows), 2 corresponds to the second dimension (columns), 3 corresponds to pages, and so on.

A	B= permute(A,[2 1 3])	C = permute(A,[3 2 1])																								
$A(:,:,1) =$ <table style="margin-left: 40px;"> <tr><td>1</td><td>2</td><td>3</td></tr> <tr><td>4</td><td>5</td><td>6</td></tr> <tr><td>7</td><td>8</td><td>9</td></tr> </table>	1	2	3	4	5	6	7	8	9	$B(:,:,1) =$ <table style="margin-left: 40px;"> <tr><td>1</td><td>4</td><td>7</td></tr> <tr><td>2</td><td>5</td><td>8</td></tr> <tr><td>3</td><td>6</td><td>9</td></tr> </table> <p style="margin-left: 40px;">Row and column subscripts are reversed (page-by-page transposition).</p>	1	4	7	2	5	8	3	6	9	$C(:,:,1) =$ <table style="margin-left: 40px;"> <tr><td>1</td><td>2</td><td>3</td></tr> <tr><td>0</td><td>5</td><td>4</td></tr> </table> <p style="margin-left: 40px;">Row and page subscripts are reversed.</p>	1	2	3	0	5	4
1	2	3																								
4	5	6																								
7	8	9																								
1	4	7																								
2	5	8																								
3	6	9																								
1	2	3																								
0	5	4																								
$A(:,:,2) =$ <table style="margin-left: 40px;"> <tr><td>0</td><td>5</td><td>4</td></tr> <tr><td>2</td><td>7</td><td>6</td></tr> <tr><td>9</td><td>3</td><td>1</td></tr> </table>	0	5	4	2	7	6	9	3	1	$B(:,:,2) =$ <table style="margin-left: 40px;"> <tr><td>0</td><td>2</td><td>9</td></tr> <tr><td>5</td><td>7</td><td>3</td></tr> <tr><td>4</td><td>6</td><td>1</td></tr> </table>	0	2	9	5	7	3	4	6	1	$C(:,:,2) =$ <table style="margin-left: 40px;"> <tr><td>4</td><td>5</td><td>6</td></tr> <tr><td>2</td><td>7</td><td>6</td></tr> </table>	4	5	6	2	7	6
0	5	4																								
2	7	6																								
9	3	1																								
0	2	9																								
5	7	3																								
4	6	1																								
4	5	6																								
2	7	6																								
		$C(:,:,3) =$ <table style="margin-left: 40px;"> <tr><td>7</td><td>8</td><td>9</td></tr> <tr><td>9</td><td>3</td><td>1</td></tr> </table>	7	8	9	9	3	1																		
7	8	9																								
9	3	1																								

For a more detailed look at the permute function, consider a four-dimensional array `A` of size 5-by-4-by-3-by-2. Rearrange the dimensions, placing the column dimension first, followed by the second page dimension, the first page dimension, then the row dimension. The result is a 4 by 2 by 3 by 5 array.

```
B = permute(A,[2 4 3 1])
```

Move dimension 2 of A to first subscript position of B, dimension 4 to second subscript position, and so on.

Input array A	Dimension	1	2	3	4
	Size	5	4	3	2

Output array B	Dimension	1	2	3	4
	Size	4	2	3	5

The order of dimensions in `permute`'s argument list determines the size and shape of the output array. In this example, the second dimension moves to the first position. Because the second dimension of the original array had size four, the output array's first dimension also has size four.

You can think of `permute`'s operation as an extension of the transpose function, which switches the row and column dimensions of a matrix. For `permute`, the order of the input dimension list determines the reordering of the subscripts. In the example above, element (4,2,1,2) of A becomes element (2,2,1,4) of B, element (5,4,3,2) of A becomes element (4,2,3,5) of B, and so on.

Inverse Permutation

The `ipermute` function is the inverse of `permute`. Given an input array A and a vector of dimensions v, `ipermute` produces an array B such that `permute(B,v)` returns A.

For example, these statements create an array E that is equal to the input array C.

```
D = ipermute(C,[1 4 2 3]);
E = permute(D,[1 4 2 3])
```

You can obtain the original array after permuting it by calling `ipermute` with the same vector of dimensions.

Computing with Multidimensional Arrays

Many of MATLAB's computational and mathematical functions accept multidimensional arrays as arguments. These functions operate on specific dimensions of multidimensional arrays; that is, they operate on individual elements, on vectors, or on matrices.

Operating on Vectors

Functions that operate on vectors, like `sum`, `mean`, and so on, by default typically work on the first nonsingleton dimension of a multidimensional array. Most of these functions optionally let you specify a particular dimension on which to operate. There are exceptions, however. For example, the `cross` function, which finds the cross product of two vectors, works on the first nonsingleton dimension having length three.

Note In many cases, these functions have other restrictions on the input arguments – for example, some functions that accept multiple arrays require that the arrays be the same size. Refer to the online help for details on function arguments.

Operating Element-by-Element

MATLAB functions that operate element-by-element on two-dimensional arrays, like the trigonometric and exponential functions in the `elfun` directory, work in exactly the same way for multidimensional cases. For example, the `sin` function returns an array the same size as the function's input argument. Each element of the output array is the sine of the corresponding element of the input array.

Similarly, the arithmetic, logical, and relational operators all work with corresponding elements of multidimensional arrays that are the same size in every dimension. If one operand is a scalar and one an array, the operator applies the scalar to each element of the array.

Operating on Planes and Matrices

Functions that operate on planes or matrices, such as the linear algebra and matrix functions in the `matfun` directory, do not accept multidimensional arrays as arguments. That is, you cannot use the functions in the `matfun` directory, or the array operators `*`, `^`, `\`, or `/`, with multidimensional arguments. Supplying multidimensional arguments or operands in these cases results in an error.

You can use indexing to apply a matrix function or operator to matrices within a multidimensional array. For example, create a three-dimensional array `A`

```
A = cat(3,[1 2 3;9 8 7;4 6 5],[0 3 2;8 8 4;5 3 5],[6 4 7;6 8 5;...
5 4 3]);
```

Applying the `eig` function to the entire multidimensional array results in an error.

```
eig(A)
??? Error using ==> eig
Input arguments must be 2-D.
```

You can, however, apply `eig` to planes within the array. For example, use colon notation to index just one page (in this case, the second) of the array.

```
eig(A(:,:,2))

ans =

    -2.6260
    12.9129
     2.7131
```

Note In the first case, subscripts are not colons, you must use `squeeze` to avoid an error. For example, `eig(A(2, :, :))` results in an error because the size of the input is `[1 3 3]`. The expression `eig(squeeze(A(2, :, :)))`, however, passes a valid two-dimensional matrix to `eig`.

Organizing Data in Multidimensional Arrays

You can use multidimensional arrays to represent data in two ways:

- As planes or pages of two-dimensional data. You can then treat these pages as matrices.
- As multivariate or multidimensional data. For example, you might have a four-dimensional array where each element corresponds to either a temperature or air pressure measurement taken at one of a set of equally spaced points in a room.

For example, consider an RGB image. For a single image, a multidimensional array is probably the easiest way to store and access data.

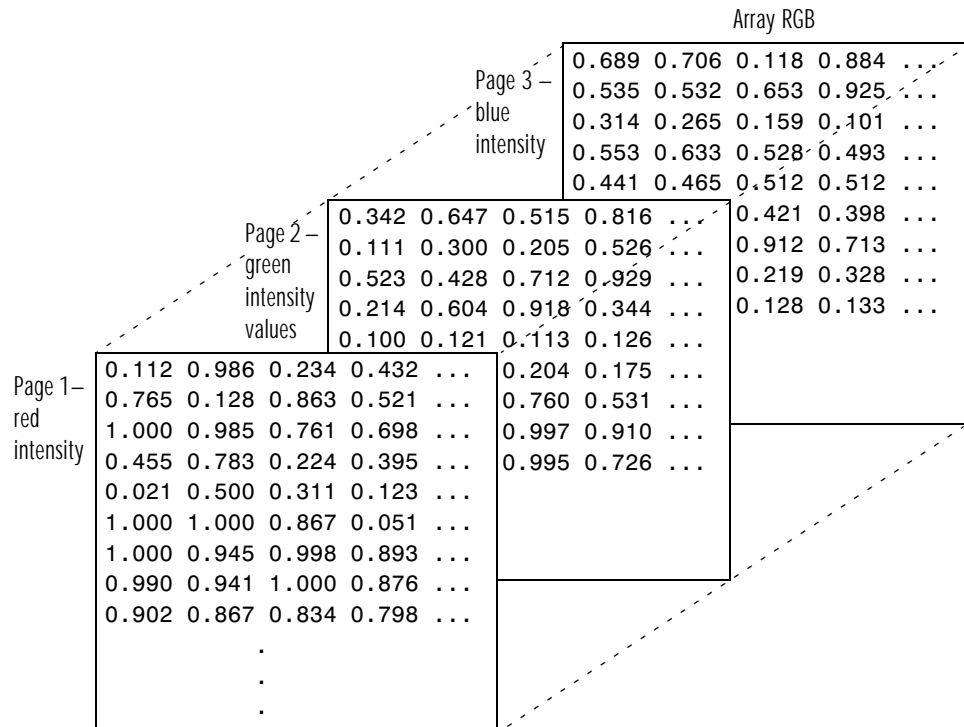

To access an entire plane of the image, use

```
red_plane = RGB(:,:,1);
```

To access a subimage, use

```
subimage = RGB(20:40,50:85,:);
```

The RGB image is a good example of data that needs to be accessed in planes for operations like display or filtering. In other instances, however, the data itself might be multidimensional. For example, consider a set of temperature measurements taken at equally spaced points in a room. Here the location of each value is an integral part of the data set – the physical placement in three-space of each element is an aspect of the information. Such data also lends itself to representation as a multidimensional array.

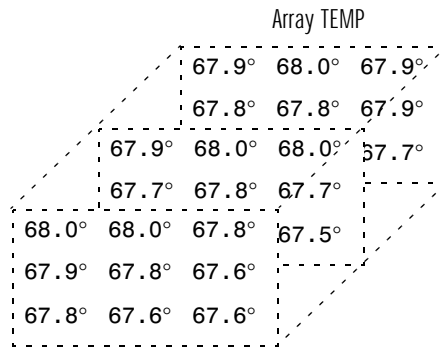

Now to find the average of all the measurements, use

```
mean(mean(mean(TEMP)));
```

To obtain a vector of the “middle” values (element (2,2)) in the room on each page, use

```
B = TEMP(2,2,:);
```

Multidimensional Cell Arrays

Like numeric arrays, the framework for multidimensional cell arrays in MATLAB is an extension of the two-dimensional cell array model. You can use the `cat` function to build multidimensional cell arrays, just as you use it for numeric arrays.

For example, create a simple three-dimensional cell array `C`.

```
A{1,1} = [1 2;4 5];
A{1,2} = 'Name';
A{2,1} = 2-4i;
A{2,2} = 7;
B{1,1} = 'Name2';
B{1,2} = 3;
B{2,1} = 0:1:3;
B{2,2} = [4 5]';
C = cat(3,A,B);
```

The subscripts for the cells of `C` look like

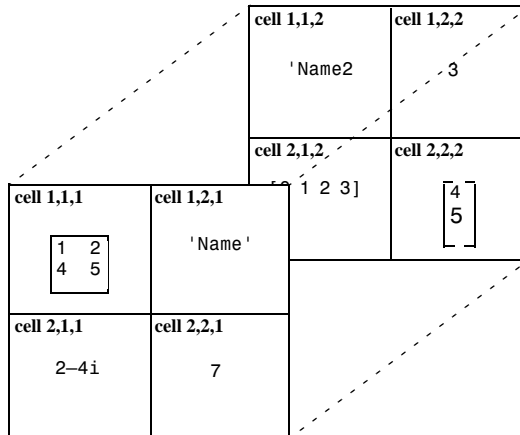

Multidimensional Structure Arrays

Multidimensional structure arrays are extensions of rectangular structure arrays. Like other types of multidimensional arrays, you can build them using direct assignment or the cat function.

```
patient(1,1,1).name = 'John Doe';patient(1,1,1).billing = 127.00;
patient(1,1,1).test = [79 75 73; 180 178 177.5; 220 210 205];
patient(1,2,1).name = 'Ann Lane';patient(1,2,1).billing = 28.50;
patient(1,2,1).test = [68 70 68; 118 118 119; 172 170 169];
patient(1,1,2).name = 'Al Smith';patient(1,1,2).billing = 504.70;
patient(1,1,2).test = [80 80 80; 153 153 154; 181 190 182];
patient(1,2,2).name = 'Dora Jones';patient(1,2,2).billing =
1173.90;
patient(1,2,2).test = [73 73 75; 103 103 102; 201 198 200];
```

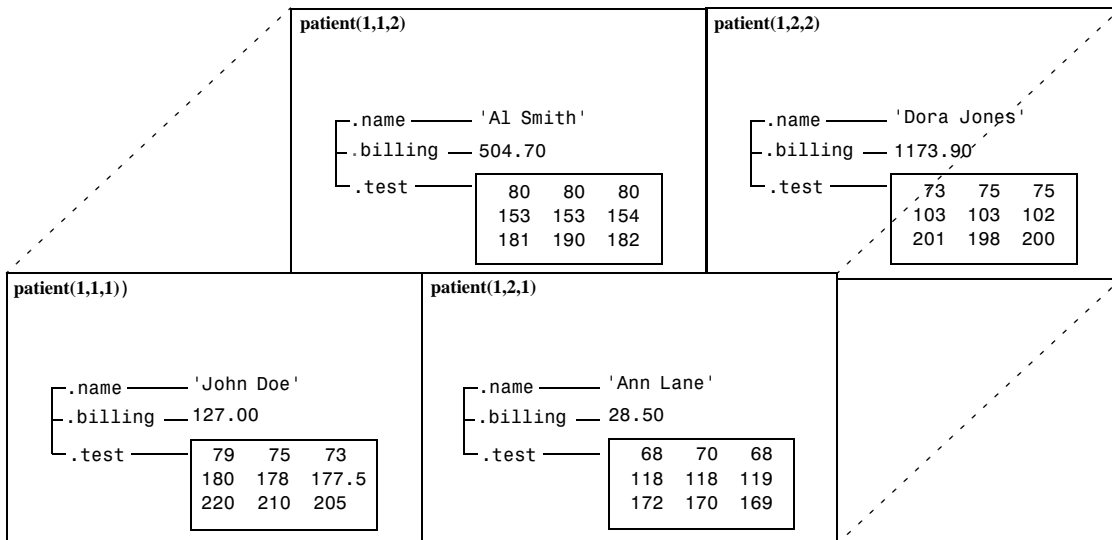

Applying Functions to Multidimensional Structure Arrays

To apply functions to multidimensional structure arrays, operate on fields and field elements using indexing. For example, find the sum of the columns of the test array in patient(1,1,2).

```
sum(patient(1,1,2).test);
```

Similarly, add all the billing fields in the patient array.

```
total = sum([patient.billing]);
```

Structures and Cell Arrays

Structures	20-4
Building Structure Arrays	20-5
Accessing Data in Structure Arrays	20-7
Finding the size of Structure Arrays	20-10
Adding Fields to Structures	20-10
Deleting Fields from Structures	20-10
Applying Functions and Operators	20-10
Writing Functions to Operate on Structures	20-11
Organizing Data in Structure Arrays	20-12
Nesting Structures	20-17
Cell Arrays	20-19
Creating Cell Arrays	20-20
Obtaining Data from Cell Arrays	20-23
Deleting Cells	20-24
Reshaping Cell Arrays	20-25
Replacing Lists of Variables with Cell Arrays	20-25
Applying Functions and Operators	20-27
Organizing Data in Cell Arrays	20-27
Nesting Cell Arrays	20-29
Converting Between Cell and Numeric Arrays	20-30
Cell Arrays of Structures	20-31

Structures are collections of different kinds of data organized by named fields. Cell arrays are a special class of MATLAB array whose elements consist of cells that themselves contain MATLAB arrays. Both structures and cell arrays provide a hierarchical storage mechanism for dissimilar kinds of data. They differ from each other primarily in the way they organize data. You access data in structures using named fields, while in cell arrays, data is accessed through matrix indexing operations.

This table describes the MATLAB functions for working with structures and cell arrays..

Category	Function	Description
Structure functions	deal	Deal inputs to outputs
	fieldnames	Get structure field names.
	getfield	Get structure field contents.
	isfield	True if field is in structure array.
	isstruct	True for structures.
	rmfield	Remove structure field.
	setfield	Set structure field contents.
	struct	Create or convert to structure array.
	struct2cell	Convert structure array into cell array.
Cell array functions	cell	Create cell array.
	cell2struct	Convert cell array into structure array.
	celldisp	Display cell array contents.
	cellfun	Apply a cell function to a cell array.
	cellplot	Display graphical depiction of cell array.
	deal	Deal inputs to outputs.
	iscell	True for cell array.

Category	Function	Description
	num2cell	Convert numeric array into cell array.
Cell array of strings functions	deblank	Remove trailing blanks from a string
	intersect	Set the intersection of two vectors
	ismember	Detect members of a set
	setdiff	Return the set difference of two vectors
	setxor	Set the exclusive-or of two vectors
	sort	Sort elements in ascending order
	strcat	Concatentate strings
	strcmp	Compare strings
	strmatch	Find possible matches for a string
	union	Set the union of two vectors
	unique	Set the unique elements of a vector

Structures

Structures are MATLAB arrays with named “data containers” called *fields*. The fields of a structure can contain any kind of data. For example, one field might contain a text string representing a name, another might contain a scalar representing a billing amount, a third might hold a matrix of medical test results, and so on.

```
patient
├── .name _____ 'John Doe'
├── .billing _____ 127.00
└── .test _____ 

|     |     |       |
|-----|-----|-------|
| 79  | 75  | 73    |
| 180 | 178 | 177.5 |
| 220 | 210 | 205   |

```

Like standard arrays, structures are inherently array oriented. A single structure is a 1-by-1 structure array, just as the value 5 is a 1-by-1 numeric array. You can build structure arrays with any valid size or shape, including multidimensional structure arrays.

Note The examples in this section focus on two-dimensional structure arrays. For examples of higher-dimension structure arrays, see Chapter 19, “Multidimensional Arrays”

The following list summarizes the contents of this section:

- “Building Structure Arrays”
- “Accessing Data in Structure Arrays”
- “Finding the size of Structure Arrays”
- “Adding Fields to Structures”
- “Deleting Fields from Structures”
- “Applying Functions and Operators”
- “Writing Functions to Operate on Structures”

- “Organizing Data in Structure Arrays”
- “Nesting Structures”

Building Structure Arrays

You can build structures in two ways:

- Using assignment statements
- Using the `struct` function

Building Structure Arrays Using Assignment Statements

You can build a simple 1-by-1 structure array by assigning data to individual fields. MATLAB automatically builds the structure as you go along. For example, create the 1-by-1 patient structure array shown at the beginning of this section.

```
patient.name = 'John Doe';  
patient.billing = 127.00;  
patient.test = [79 75 73; 180 178 177.5; 220 210 205];
```

Now entering

```
patient
```

at the command line results in

```
name: 'John Doe'  
billing: 127  
test: [3x3 double]
```

`patient` is an array containing a structure with three fields. To expand the structure array, add subscripts after the structure name.

```
patient(2).name = 'Ann Lane';  
patient(2).billing = 28.50;  
patient(2).test = [68 70 68; 118 118 119; 172 170 169];
```

The `patient` structure array now has size `[1 2]`. Note that once a structure array contains more than a single element, MATLAB does not display individual field contents when you type the array name. Instead, it shows a summary of the kind of information the structure contains.

```
patient

patient =

1x2 struct array with fields:
    name
    billing
    test
```

You can also use the `fieldnames` function to obtain this information. `fieldnames` returns a cell array of strings containing field names.

As you expand the structure, MATLAB fills in unspecified fields with empty matrices so that:

- All structures in the array have the same number of fields.
- All fields have the same field names.

For example, entering `patient(3).name = 'Alan Johnson'` expands the `patient` array to size `[1 3]`. Now both `patient(3).billing` and `patient(3).test` contain empty matrices.

Note Field sizes do not have to conform for every element in an array. In the `patient` example, the `name` fields can have different lengths, the `test` fields can be arrays of different sizes, and so on.

Building Structure Arrays Using the `struct` Function

You can preallocate an array of structures with the `struct` function. Its basic form is

```
str_array = struct('field1',val1,'field2',val2, ...)
```

where the arguments are field names and their corresponding values. A field value can be a single value, represented by any MATLAB data construct, or a cell array of values. All field values in the argument list must be of the same scale (single value or cell array).

You can use different methods for preallocating structure arrays. These methods differ in the way in which the structure fields are initialized. As an

example, consider the allocation of a 1-by-3 structure array, `weather`, with the structure fields `temp` and `rainfall`. Three different methods for allocating such an array are shown in this table.

Method	Syntax	Initialization
struct	<code>weather(3) = struct('temp',72,'rainfall',0.0);</code>	<code>weather(3)</code> is initialized with the field values shown. The fields for the other structures in the array, <code>weather(1)</code> and <code>weather(2)</code> , are initialized to the empty matrix.
struct with repmat	<code>weather = repmat(struct('temp',72,'rainfall',0.0),1,3);</code>	All structures in the <code>weather</code> array are initialized using one set of field values.
struct with cell array syntax	<code>weather = struct('temp',{68,80,72}, 'rainfall',{0.2,0.4,0.0});</code>	The structures in the <code>weather</code> array are initialized with distinct field values specified with cell arrays.

Accessing Data in Structure Arrays

Using structure array indexing, you can access the value of any field or field element in a structure array. Likewise, you can assign a value to any field or field element. For the examples in this section, consider this structure array.

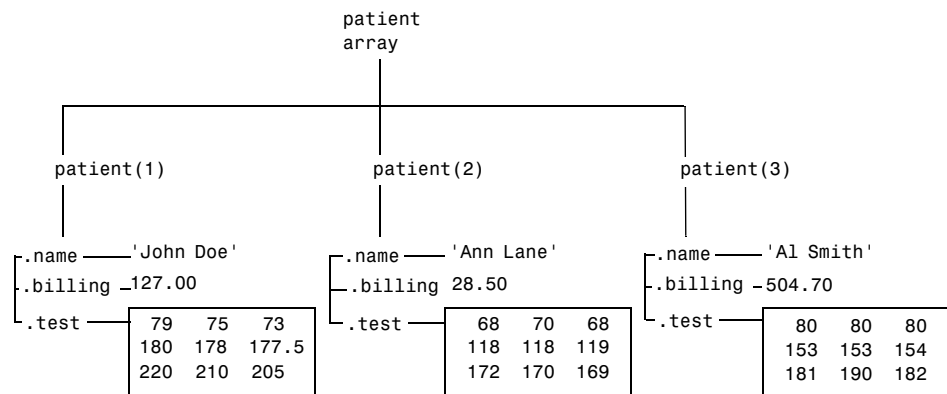

You can access subarrays by appending standard subscripts to a structure array name. For example, the line below results in a 1-by-2 structure array.

```
mypatients = patient(1:2)

1x2 struct array with fields:
    name
    billing
    test
```

The first structure in the `mypatients` array is the same as the first structure in the `patient` array.

```
mypatients(1)

ans =

    name: 'John Doe'
    billing: 127
    test: [3x3 double]
```

To access a field of a particular structure, include a period (.) after the structure name followed by the field name.

```
str = patient(2).name

str =

Ann Lane
```

To access elements within fields, append the appropriate indexing mechanism to the field name. That is, if the field contains an array, use array subscripting; if the field contains a cell array, use cell array subscripting, and so on.

```
test2b = patient(3).test(2,2)

test2b =

    153
```

Use the same notations to assign values to structure fields, for example,

```
patient(3).test(2,2) = 7;
```

You can extract field values for multiple structures at a time. For example, the line below creates a 1-by-3 vector containing all of the billing fields.

```
bills = [patient.billing]

bills =

    127.0000    28.5000    504.7000
```

Similarly, you can create a cell array containing the test data for the first two structures.

```
tests = {patient(1:2).test}

tests =

    [3x3 double]    [3x3 double]
```

Accessing Field Values Using `setfield` and `getfield`

Direct indexing is usually the most efficient way to assign or retrieve field values. If, however, you only know the field name as a string – for example, if you have used the `fieldnames` function to obtain the field name within an M-file – you can use the `setfield` and `getfield` functions to do the same thing.

`getfield` obtains a value or values from a field or field element

```
f = getfield(array,{array_index},'field',{field_index})
```

where the `field_index` is optional, and `array_index` is optional for a 1-by-1 structure array. The function syntax corresponds to

```
f = array(array_index).field(field_index);
```

For example, to access the name field in the second structure of the patient array, use:

```
str = getfield(patient,{2},'name');
```

Similarly, `setfield` lets you assign values to fields using the syntax

```
f = setfield(array,{array_index},'field',{field_index},value)
```

Finding the size of Structure Arrays

Use the `size` function to obtain the size of a structure array, or of any structure field. Given a structure array name as an argument, `size` returns a vector of array dimensions. Given an argument in the form `array(n).field`, the `size` function returns a vector containing the size of the field contents.

For example, for the 1-by-3 structure array `patient`, `size(patient)` returns the vector `[1 3]`. The statement `size(patient(1,2).name)` returns the length of the name string for element `(1,2)` of `patient`.

Adding Fields to Structures

You can add a field to every structure in an array by adding the field to a single structure. For example, to add a social security number field to the `patient` array, use an assignment like

```
patient(2).ssn = '000-00-0000';
```

Now `patient(2).ssn` has the assigned value. Every other structure in the array also has the `ssn` field, but these fields contain the empty matrix until you explicitly assign a value to them.

Deleting Fields from Structures

You can remove a given field from every structure within a structure array using the `rmfield` function. Its most basic form is

```
struc2 = rmfield(array,'field')
```

where `array` is a structure array and `'field'` is the name of a field to remove from it. To remove the name field from the `patient` array, for example, enter:

```
patient = rmfield(patient,'name');
```

Applying Functions and Operators

Operate on fields and field elements the same way you operate on any other MATLAB array. Use indexing to access the data on which to operate. For example, this statement finds the mean across the rows of the `test` array in `patient(2)`.

```
mean((patient(2).test)');
```

There are sometimes multiple ways to apply functions or operators across fields in a structure array. One way to add all the billing fields in the patient array is

```
total = 0;
for k = 1:length(patient)
    total = total + patient(k).billing;
end
```

To simplify operations like this, MATLAB enables you to operate on all like-named fields in a structure array. Simply enclose the `array.field` expression in square brackets within the function call. For example, you can sum all the billing fields in the patient array using

```
total = sum ([patient.billing]);
```

This is equivalent to using the comma-separated list.

```
total = sum ([patient(1).billing, patient(2).billing...]);
```

This syntax is most useful in cases where the operand field is a scalar field.

Writing Functions to Operate on Structures

You can write functions that work on structures with specific field architectures. Such functions can access structure fields and elements for processing.

Note When writing M-file functions to operate on structures, you must perform your own error checking. That is, you must ensure that the code checks for the expected fields.

As an example, consider a collection of data that describes measurements, at different times, of the levels of various toxins in a water source. The data consists of fifteen separate observations, where each observation contains three separate measurements.

You can organize this data into an array of 15 structures, where each structure has three fields, one for each of the three measurements taken.

The function `concen`, shown below, operates on an array of structures with specific characteristics. Its arguments must contain the fields `lead`, `mercury`, and `chromium`.

```
function [r1,r2] = concen(toxtest);
% Create two vectors. r1 contains the ratio of mercury to lead
% at each observation. r2 contains the ratio of lead to chromium.
r1 = [toxtest.mercury]./[toxtest.lead];
r2 = [toxtest.lead]./[toxtest.chromium];
% Plot the concentrations of lead, mercury, and chromium
% on the same plot, using different colors for each.
lead = [toxtest.lead];
mercury = [toxtest.mercury];
chromium = [toxtest.chromium];
plot(lead,'r'); hold on
plot(mercury,'b')
plot(chromium,'y'); hold off
```

Try this function with a sample structure array like `test`.

```
test(1).lead = .007; test(2).lead = .031; test(3).lead = .019;
test(1).mercury = .0021; test(2).mercury = .0009;
test(3).mercury = .0013;
test(1).chromium = .025; test(2).chromium = .017;
test(3).chromium = .10;
```

Organizing Data in Structure Arrays

The key to organizing structure arrays is to decide how you want to access subsets of the information. This, in turn, determines how you build the array that holds the structures, and how you break up the structure fields.

There are at least two ways you can organize such data into a structure array.

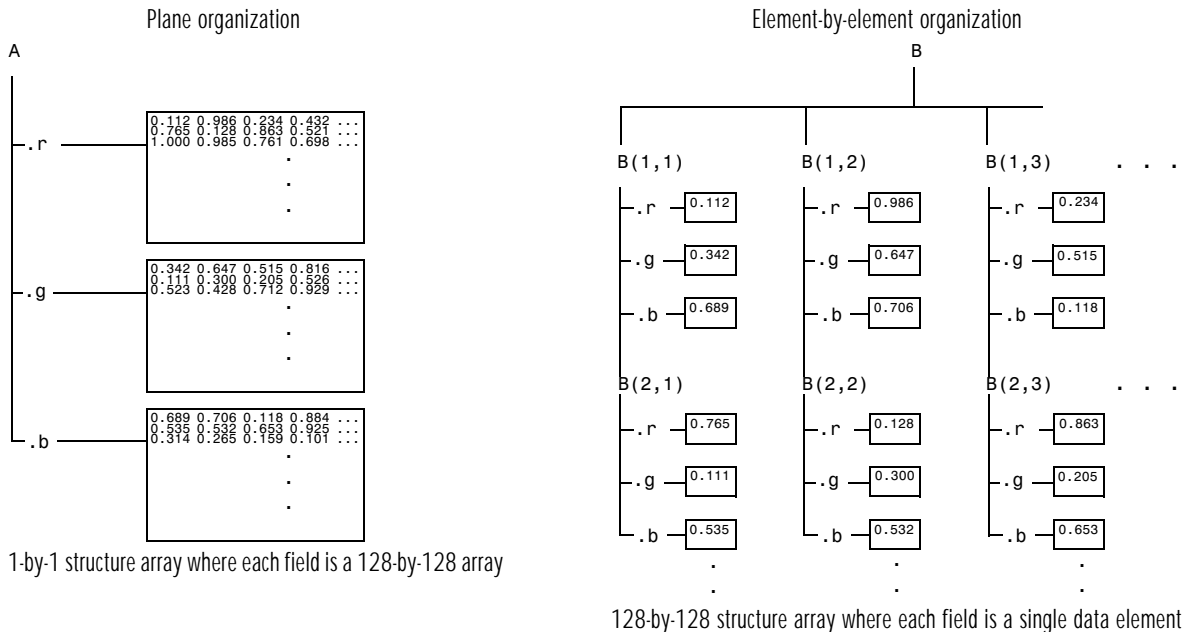

1-by-1 structure array where each field is a 128-by-128 array

128-by-128 structure array where each field is a single data element

Plane Organization

In case 1 above, each field of the structure is an entire plane of the image. You can create this structure using

```
A.r = RED;
A.g = GREEN;
A.b = BLUE;
```

This approach allows you to easily extract entire image planes for display, filtering, or other tasks that work on the entire image at once. To access the entire red plane, for example, use

```
red_plane = A.r;
```

Plane organization has the additional advantage of being extensible to multiple images in this case. If you have a number of images, you can store them as A(2), A(3), and so on, each containing an entire image.

The disadvantage of plane organization is evident when you need to access subsets of the planes. To access a subimage, for example, you need to access each field separately.

```
red_sub = A.r(2:12,13:30);
grn_sub = A.g(2:12,13:30);
blue_sub = A.b(2:12,13:30);
```

Element-by-Element Organization

Case 2 has the advantage of allowing easy access to subsets of data. To set up the data in this organization, use

```
for m = 1:size(RED,1)
    for n = 1:size(RED,2)
        B(m,n).r = RED(m,n);
        B(m,n).g = GREEN(m,n);
        B(m,n).b = BLUE(m,n);
    end
end
```

With element-by-element organization, you can access a subset of data with a single statement.

```
Bsub = B(1:10,1:10);
```

To access an entire plane of the image using the element-by-element method, however, requires a loop.

```
red_plane = zeros(128,128);
for k = 1:(128*128)
    red_plane(k) = B(k).r;
end
```

Element-by-element organization is not the best structure array choice for most image processing applications; however, it can be the best for other applications wherein you will routinely need to access corresponding subsets of structure fields. The example in the following section demonstrates this type of application.

Example - A Simple Database

Consider organizing a simple database.

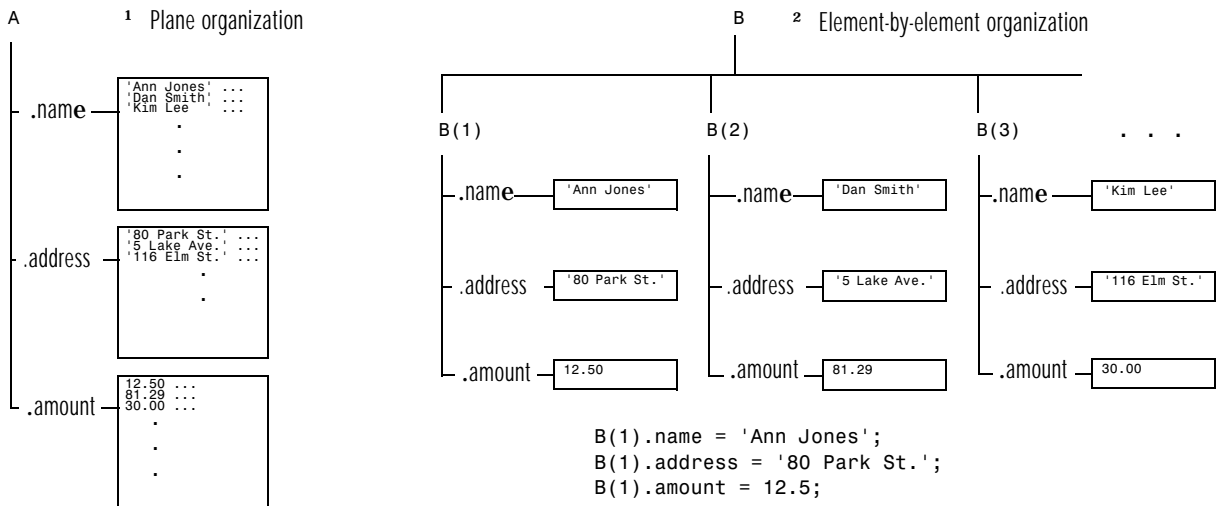

```

A.name = strvcat('Ann Jones','Dan Smith',...);
A.address = strvcat('80 Park St.','5 Lake Ave.',...);
A.amount = [12.5;81.29;30; ...];

B(2).name = 'Dan Smith';
B(2).address = '5 Lake Ave.';
B(2).amount = 81.29;
    
```

Each of the possible organizations has advantages depending on how you want to access the data:

- **Plane organization makes it easier to operate on all field values at once.** For example, to find the average of all the values in the amount field,
 - Using plane organization

```
avg = mean(A.amount);
```
 - Using element-by-element organization

```
avg = mean([B.amount]);
```

- Element-by-element organization makes it easier to access all the information related to a single client. Consider an M-file, `client.m`, which displays the name and address of a given client on screen.

Using plane organization, pass individual fields.

```
function client(name,address)
disp(name)
disp(address)
```

To call the `client` function,

```
client(A.name(2,:),A.address(2,:))
```

Using element-by-element organization, pass an entire structure.

```
function client(B)
disp(B)
```

To call the `client` function,

```
client(B(2))
```

- Element-by-element organization makes it easier to expand the string array fields. If you do not know the maximum string length ahead of time for plane organization, you may need to frequently recreate the name or address field to accommodate longer strings.

Typically, your data does not dictate the organization scheme you choose. Rather, you must consider how you want to access and operate on the data.

Nesting Structures

A structure field can contain another structure, or even an array of structures. Once you have created a structure, you can use the `struct` function or direct assignment statements to nest structures within existing structure fields.

Building Nested Structures with the `struct` Function

To build nested structures, you can nest calls to the `struct` function. For example, create a 1-by-1 structure array.

```
A = struct('data',[3 4 7; 8 0 1],'nest',...
    struct('testnum','Test 1', 'xdata',[4 2 8],...
    'ydata',[7 1 6]));
```

You can build nested structure arrays using direct assignment statements. These statements add a second element to the array.

```
A(2).data = [9 3 2; 7 6 5];  
A(2).nest.testnum = 'Test 2';  
A(2).nest.xdata = [3 4 2];  
A(2).nest.ydata = [5 0 9];
```

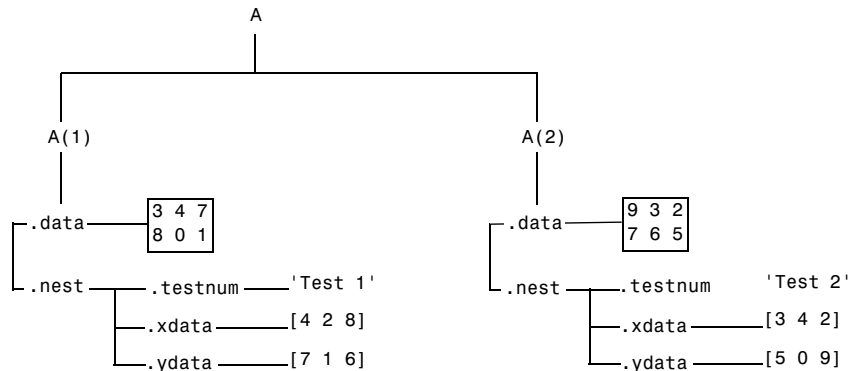

Indexing Nested Structures

To index nested structures, append nested field names using dot notation. The first text string in the indexing expression identifies the structure array, and subsequent expressions access field names that contain other structures.

For example, the array `A` created earlier has three levels of nesting:

- To access the nested structure inside `A(1)`, use `A(1).nest`.
- To access the `xdata` field in the nested structure in `A(2)`, use `A(2).nest.xdata`.
- To access element 2 of the `ydata` field in `A(1)`, use `A(1).nest.ydata(2)`.

Cell Arrays

A *cell array* is a MATLAB array for which the elements are *cells*, containers that can hold other MATLAB arrays. For example, one cell of a cell array might contain a real matrix, another an array of text strings, and another a vector of complex values.

<p>cell 1,1</p> <table border="1" data-bbox="476 552 617 652"> <tr><td>3</td><td>4</td><td>2</td></tr> <tr><td>9</td><td>7</td><td>6</td></tr> <tr><td>8</td><td>5</td><td>1</td></tr> </table>	3	4	2	9	7	6	8	5	1	<p>cell 1,2</p> <table border="1" data-bbox="743 513 939 696"> <tr><td>'Anne Smith'</td></tr> <tr><td>'9/12/94'</td></tr> <tr><td>'Class II'</td></tr> <tr><td>'Obs. 1'</td></tr> <tr><td>'Obs. 2'</td></tr> </table>	'Anne Smith'	'9/12/94'	'Class II'	'Obs. 1'	'Obs. 2'	<p>cell 1,3</p> <table border="1" data-bbox="1035 552 1233 652"> <tr><td>.25+3i</td><td>8-16i</td></tr> <tr><td>34+5i</td><td>7+.92i</td></tr> </table>	.25+3i	8-16i	34+5i	7+.92i	
3	4	2																			
9	7	6																			
8	5	1																			
'Anne Smith'																					
'9/12/94'																					
'Class II'																					
'Obs. 1'																					
'Obs. 2'																					
.25+3i	8-16i																				
34+5i	7+.92i																				
<p>cell 2,1</p> <table border="1" data-bbox="439 864 658 939"> <tr><td>[1.43 2.98</td></tr> <tr><td>5.67]</td></tr> </table>	[1.43 2.98	5.67]	<p>cell 2,2</p> <table border="1" data-bbox="765 829 917 930"> <tr><td>7</td><td>2</td><td>14</td></tr> <tr><td>8</td><td>3</td><td>45</td></tr> <tr><td>52</td><td>16</td><td>3</td></tr> </table>	7	2	14	8	3	45	52	16	3	<p>cell 2,3</p> <table border="1" data-bbox="1003 782 1267 999"> <tr> <td data-bbox="1003 782 1136 895">'text'</td> <td data-bbox="1136 782 1267 895"> <table border="1"> <tr><td>4</td><td>2</td></tr> <tr><td>1</td><td>5</td></tr> </table> </td> </tr> <tr> <td data-bbox="1003 895 1136 999">[4 2 7]</td> <td data-bbox="1136 895 1267 999">.02 + 8i</td> </tr> </table>	'text'	<table border="1"> <tr><td>4</td><td>2</td></tr> <tr><td>1</td><td>5</td></tr> </table>	4	2	1	5	[4 2 7]	.02 + 8i
[1.43 2.98																					
5.67]																					
7	2	14																			
8	3	45																			
52	16	3																			
'text'	<table border="1"> <tr><td>4</td><td>2</td></tr> <tr><td>1</td><td>5</td></tr> </table>	4	2	1	5																
4	2																				
1	5																				
[4 2 7]	.02 + 8i																				

You can build cell arrays of any valid size or shape, including multidimensional structure arrays.

Note The examples in this section focus on two-dimensional cell arrays. For examples of higher-dimension cell arrays, see Chapter 19, “Multidimensional Arrays”.

The following list summarizes the contents of this section:

- “Creating Cell Arrays”
- “Obtaining Data from Cell Arrays”
- “Deleting Cells”

- “Reshaping Cell Arrays”
- “Replacing Lists of Variables with Cell Arrays”
- “Applying Functions and Operators”
- “Organizing Data in Cell Arrays”
- “Nesting Cell Arrays”
- “Converting Between Cell and Numeric Arrays”
- “Cell Arrays of Structures”

Creating Cell Arrays

You can create cell arrays by:

- Using assignment statements
- Preallocating the array using the `cell` function, then assigning data to cells

Using Assignment Statements

You can build a cell array by assigning data to individual cells, one cell at a time. MATLAB automatically builds the array as you go along. There are two ways to assign data to cells:

- Cell indexing

Enclose the cell subscripts in parentheses using standard array notation.

Enclose the cell contents on the right side of the assignment statement in curly braces, “{}.” For example, create a 2-by-2 cell array A.

```
A(1,1) = {[1 4 3; 0 5 8; 7 2 9]};  
A(1,2) = {'Anne Smith'};  
A(2,1) = {3+7i};  
A(2,2) = {-pi:pi/10:pi};
```

Note The notation “{}” denotes the empty cell array, just as “[]” denotes the empty matrix for numeric arrays. You can use the empty cell array in any cell array assignments.

- Content indexing

Enclose the cell subscripts in curly braces using standard array notation. Specify the cell contents on the right side of the assignment statement.

```
A{1,1} = [1 4 3; 0 5 8; 7 2 9];
A{1,2} = 'Anne Smith';
A{2,1} = 3+7i;
A{2,2} = -pi:pi/10:pi;
```

The various examples in this guide do not use one syntax throughout, but attempt to show representative usage of cell and content addressing. You can use the two forms interchangeably.

Note If you already have a numeric array of a given name, don't try to create a cell array of the same name by assignment without first clearing the numeric array. If you do not clear the numeric array, MATLAB assumes that you are trying to "mix" cell and numeric syntaxes, and generates an error. Similarly, MATLAB does not clear a cell array when you make a single assignment to it. If any of the examples in this section give unexpected results, clear the cell array from the workspace and try again.

MATLAB displays the cell array A in a condensed form.

```
A =
      [3x3 double]      'Anne Smith'
      [3.0000+ 7.0000i]  [1x21 double]
```

To display the full cell contents, use the `celldisp` function. For a high-level graphical display of cell architecture, use `cellplot`.

If you assign data to a cell that is outside the dimensions of the current array, MATLAB automatically expands the array to include the subscripts you specify. It fills any intervening cells with empty matrices. For example, the assignment below turns the 2-by-2 cell array A into a 3-by-3 cell array.

A(3,3) = {5};

cell 1,1 <table border="1"> <tr><td>1</td><td>4</td><td>3</td></tr> <tr><td>0</td><td>5</td><td>8</td></tr> <tr><td>7</td><td>2</td><td>9</td></tr> </table>	1	4	3	0	5	8	7	2	9	cell 1,2 'Anne Smith'	cell 1,3 []
1	4	3									
0	5	8									
7	2	9									
cell 2,1 3+7i	cell 2,2 <table border="1"> <tr><td>[-3.14...3.14]</td></tr> </table>	[-3.14...3.14]	cell 2,3 []								
[-3.14...3.14]											
cell 3,1 []	cell 3,2 []	cell 3,3 5									

Cell Array Syntax: Using Braces

The curly braces, “{}”, are cell array constructors, just as square brackets are numeric array constructors. Curly braces behave similarly to square brackets, except that you can nest curly braces to denote nesting of cells (see “Nesting Cell Arrays” for details).

Curly braces use commas or spaces to indicate column breaks and semicolons to indicate row breaks between cells. For example,

C = {[1 2], [3 4]; [5 6], [7 8]};

results in

cell 1,1 [1 2]	cell 1,2 [3 4]
cell 2,1 [5 6]	cell 2,2 [7 8]

Use square brackets to concatenate cell arrays, just as you do for numeric arrays.

Preallocating Cell Arrays with the cell Function

The `cell` function allows you to preallocate empty cell arrays of the specified size. For example, this statement creates an empty 2-by-3 cell array.

```
B = cell(2,3);
```

Use assignment statements to fill the cells of B.

```
B(1,3) = {1:3};
```

Obtaining Data from Cell Arrays

You can obtain data from cell arrays and store the result as either a standard array or a new cell array. This section discusses:

- Accessing cell contents using content indexing
- Accessing a subset of cells using cell indexing

Accessing Cell Contents Using Content Indexing

You can use content indexing on the right side of an assignment to access some or all of the data in a single cell. Specify the variable to receive the cell contents on the left side of the assignment. Enclose the cell index expression on the right side of the assignment in curly braces. This indicates that you are assigning cell contents, not the cells themselves.

Consider the 2-by-2 cell array N.

```
N{1,1} = [1 2; 4 5];  
N{1,2} = 'Name';  
N{2,1} = 2-4i;  
N{2,2} = 7;
```

You can obtain the string in N{1,2} using

```
c = N{1,2}
```

```
c =
```

```
Name
```

Note In assignments, you can use content indexing to access only a single cell, not a subset of cells. For example, the statements $A\{1, : \} = value$ and $B = A\{1, : \}$ are both invalid. However, you can use a subset of cells any place you would normally use a comma-separated list of variables (for example, as function inputs or when building an array). See the “Replacing Lists of Variables with Cell Arrays” section for details.

To obtain subsets of a cell’s contents, concatenate indexing expressions. For example, to obtain element (2,2) of the array in cell $N\{1, 1\}$, use:

```
d = N{1,1}(2,2)
```

```
d =
```

```
5
```

Accessing a Subset of Cells Using Cell Indexing

Use cell indexing to assign any set of cells to another variable, creating a new cell array. Use the colon operator to access subsets of cells within a cell array.

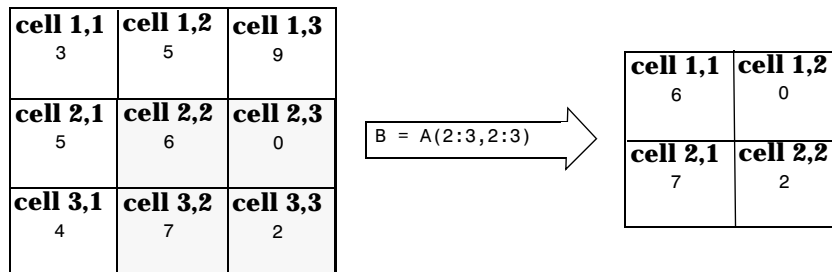

Deleting Cells

You can delete an entire dimension of cells using a single statement. Like standard array deletion, use vector subscripting when deleting a row or column of cells and assign the empty matrix to the dimension.

```
A(cell_subscripts) = []
```

When deleting cells, curly braces do not appear in the assignment statement at all.

Reshaping Cell Arrays

Like other arrays, you can reshape cell arrays using the reshape function. The number of cells must remain the same after reshaping; you cannot use reshape to add or remove cells.

```
A = cell(3,4);
size(A)

ans =
     3     4

B = reshape(A,6,2);
size(B)

ans =
     6     2
```

Replacing Lists of Variables with Cell Arrays

Cell arrays can replace comma-separated lists of MATLAB variables in:

- Function input lists
- Function output lists
- Display operations
- Array constructions (square brackets and curly braces)

If you use the colon to index multiple cells in conjunction with the curly brace notation, MATLAB treats the contents of each cell as a separate variable. For example, assume you have a cell array T where each cell contains a separate vector. The expression $T\{1:5\}$ is equivalent to a comma-separated list of the vectors in the first five cells of T .

Consider the cell array C .

```
C(1) = {[1 2 3]};
C(2) = {[1 0 1]};
C(3) = {1:10};
```

```
C(4) = {[9 8 7]};  
C(5) = {3};
```

To convolve the vectors in C(1) and C(2) using conv,

```
d = conv(C{1:2})
```

```
d =
```

```
1 2 4 2 3
```

Display vectors two, three, and four with

```
C{2:4}
```

```
ans =
```

```
1 0 1
```

```
ans =
```

```
1 2 3 4 5 6 7 8 9 10
```

```
ans =
```

```
9 8 7
```

Similarly, you can create a new numeric array using the statement

```
B = [C{1}; C{2}; C{4}]
```

```
B =
```

```
1 2 3  
1 0 1  
9 8 7
```

You can also use content indexing on the left side of an assignment to create a new cell array where each cell represents a separate output argument.

```
[D{1:2}] = eig(B)
```

```
D =
      [3x3 double]      [3x3 double]
```

You can display the actual eigenvalues and eigenvectors using `D{1}` and `D{2}`.

Note The `varargin` and `varargout` arguments allow you to specify variable numbers of input and output arguments for MATLAB functions that you create. Both `varargin` and `varargout` are cell arrays, allowing them to hold various sizes and kinds of MATLAB data. See “Passing Variable Numbers of Arguments” on page 17-16 for details.

Applying Functions and Operators

Use indexing to apply functions and operators to the contents of cells. For example, use content indexing to call a function with the contents of a single cell as an argument.

```
A{1,1} = [1 2; 3 4];
A{1,2} = randn(3,3);
A{1,3} = 1:5;
B = sum(A{1,1})
```

```
B =
      4      6
```

To apply a function to several cells of a non-nested cell array, use a loop.

```
for k = 1:length(A)
    M{k} = sum(A{1,k});
end
```

Organizing Data in Cell Arrays

Cell arrays are useful for organizing data that consists of different sizes or kinds of data. Cell arrays are better than structures for applications where:

- You need to access multiple fields of data with one statement.

- You want to access subsets of the data as comma-separated variable lists.
- You don't have a fixed set of field names.
- You routinely remove fields from the structure.

As an example of accessing multiple fields with one statement, assume that your data consists of:

- A 3-by-4 array consisting of measurements taken for an experiment.
- A 15-character string containing a technician's name.
- A 3-by-4-by-5 array containing a record of measurements taken for the past five experiments.

For many applications, the best data construct for this data is a structure. However, if you routinely access only the first two fields of information, then a cell array might be more convenient for indexing purposes.

This example shows how to access the first and second elements of the cell array TEST.

```
[newdata,name] = deal(TEST{1:2})
```

This example shows how to access the first and second elements of the structure TEST.

```
newdata = TEST.measure  
name = TEST.name
```

The `varargin` and `varargout` arguments are examples of the utility of cell arrays as substitutes for comma-separated lists. Create a 3-by-3 numeric array A.

```
A = [0 1 2;4 0 7;3 1 2];
```

Now apply the `normest` (2-norm estimate) function to A, and assign the function output to individual cells of B.

```
[B{1:2}] = normest(A)
```

```
B =
```

```
    [8.8826]    [4]
```

All of the output values from the function are stored in separate cells of B. B(1) contains the norm estimate; B(2) contains the iteration count.

Nesting Cell Arrays

A cell can contain another cell array, or even an array of cell arrays. (Cells that contain noncell data are called *leaf cells*.) You can use nested curly braces, the `cell` function, or direct assignment statements to create nested cell arrays. You can then access and manipulate individual cells, subarrays of cells, or cell elements.

Building Nested Arrays with Nested Curly Braces

You can nest pairs of curly braces to create a nested cell array. For example,

```
clear A
A(1,1) = {magic(5)};
A(1,2) = {[5 2 8; 7 3 0; 6 7 3] 'Test 1'; [2-4i 5+7i] {17 []}}
A =

    [5x5 double]    {2x2 cell}
```

Note that the right side of the assignment is enclosed in two sets of curly braces. The first set represents cell (1,2) of cell array A. The second “packages” the 2-by-2 cell array inside the outer cell.

Building Nested Arrays with the `cell` Function

To nest cell arrays with the `cell` function, assign the output of `cell` to an existing cell:

- 1 Create an empty 1-by-2 cell array.

```
A = cell(1,2);
```

- 2 Create a 2-by-2 cell array inside A(1,2).

```
A(1,2) = {cell(2,2)};
```

- 3 Fill A, including the nested array, using assignments.

```
A(1,1) = {magic(5)};
A{1,2}(1,1) = {[5 2 8; 7 3 0; 6 7 3]};
```

```

A{1,2}(1,2) = {'Test 1'};
A{1,2}(2,1) = {[2-4i 5+7i]};
A{1,2}(2,2) = {cell(1,2)}
A{1,2}{2,2}(1) = {17};

```

Note the use of curly braces until the final level of nested subscripts. This is required because you need to access cell contents to access cells within cells.

You can also build nested cell arrays with direct assignments using the statements shown in step 3 above.

Indexing Nested Cell Arrays

To index nested cells, concatenate indexing expressions. The first set of subscripts accesses the top layer of cells, and subsequent sets of parentheses access successively deeper layers.

For example, array A has three levels of nesting:

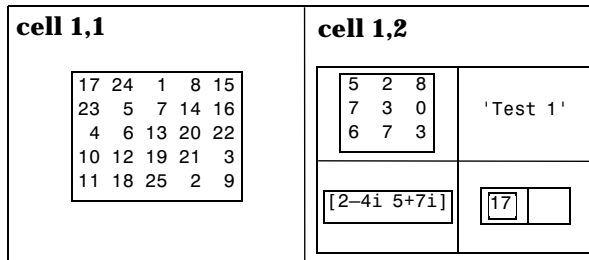

- To access the 5-by-5 array in cell (1,1), use $A\{1,1\}$.
- To access the 3-by-3 array in position (1,1) of cell (1,2), use $A\{1,2\}\{1,1\}$.
- To access the 2-by-2 cell array in cell (1,2), use $A\{1,2\}$.
- To access the empty cell in position (2,2) of cell (1,2), use $A\{1,2\}\{2,2\}\{1,2\}$.

Converting Between Cell and Numeric Arrays

Use for loops to convert between cell and numeric formats. For example, create a cell array F.

```

F{1,1} = [1 2; 3 4];
F{1,2} = [-1 0; 0 1];

```



```
F{2,1} = [7 8; 4 1];
F{2,2} = [4i 3+2i; 1-8i 5];
```

Now use three for loops to copy the contents of F into a numeric array NUM.

```
for k = 1:4
    for m = 1:2
        for n = 1:2
            NUM(m,n,k) = F{k}(m,n);
        end
    end
end
```

Similarly, you must use for loops to assign each value of a numeric array to a single cell of a cell array.

```
G = cell(1,16);
for m = 1:16
    G{m} = NUM(m);
end
```

Cell Arrays of Structures

Use cell arrays to store groups of structures with different field architectures.

```
c_str = cell(1,2);
c_str{1}.label = '12/2/94 - 12/5/94';
c_str{1}.obs = [47 52 55 48; 17 22 35 11];
c_str{2}.xdata = [-0.03 0.41 1.98 2.12 17.11];
c_str{2}.ydata = [-3 5 18 0 9];
c_str{2}.zdata = [0.6 0.8 1 2.2 3.4];
```

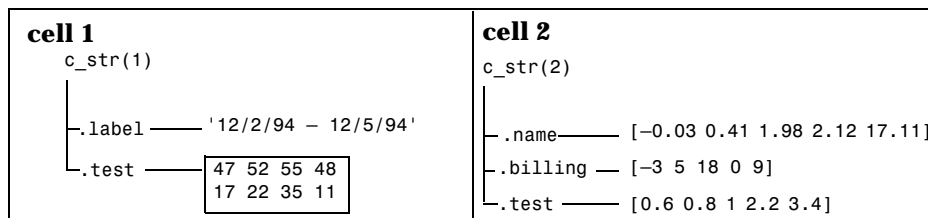

Cell 1 of the `c_str` array contains a structure with two fields, one a string and the other a vector. Cell 2 contains a structure with three vector fields.

When building cell arrays of structures, you must use content indexing. Similarly, you must use content indexing to obtain the contents of structures within cells. The syntax for content indexing is:

```
cell_array{index}.field
```

For example, to access the `label` field of the structure in cell 1, use `c_str{1}.label`.

Function Handles

Benefits of Using Function Handles	21-3
A Simple Function Handle	21-5
Constructing a Function Handle	21-7
Maximum Length of a Function Name	21-7
Evaluating a Function Through Its Handle	21-9
Function Evaluation and Overloading	21-9
Examples of Function Handle Evaluation	21-10
Displaying Function Handle Information	21-13
Fields Returned by the Functions Command	21-14
Types of Function Handles	21-17
Function Handle Operations	21-21
Converting Function Handles to Function Names	21-21
Converting Function Names to Function Handles	21-22
Testing for Data Type	21-23
Testing for Equality	21-23
Saving and Loading Function Handles	21-25
Handling Error Conditions	21-26
Handles to Nonexistent Functions	21-26
Including Path In the Function Handle Constructor	21-26
Evaluating a Nonscalar Function Handle	21-27
Historical Note - Evaluating Function Names	21-28

A *function handle* is a MATLAB data type that contains information used in referencing a function. When you create a function handle, MATLAB stores in the handle all the information about the function that it needs to execute, or *evaluate*, it later on. Typically, a function handle is passed in an argument list to other functions. It is then used in conjunction with `feval` to evaluate the function to which the handle belongs.

A MATLAB function handle is more than just a reference to a function. It often represents a collection of function methods, overloaded to handle different argument types. When you create a handle to a function, MATLAB takes a snapshot of all built-in and M-file methods of that name that are on the MATLAB path and in scope at that time, and stores access information for all of those methods in the handle.

When you evaluate a function handle, MATLAB considers only those functions that were stored within the handle when it was created. Other functions that might now be on the path or in scope are not considered. It is the combination of which function methods are mapped to by the handle and what arguments the handle is evaluated with that determines which is the actual function that MATLAB dispatches to.

This chapter addresses the following topics:

- “Benefits of Using Function Handles”
- “Constructing a Function Handle”
- “Evaluating a Function Through Its Handle”
- “Displaying Function Handle Information”
- “Function Handle Operations”
- “Saving and Loading Function Handles”
- “Handling Error Conditions”
- “Historical Note - Evaluating Function Names”

Benefits of Using Function Handles

Function handles enable you to do all of the following:

- Pass function access information to other functions
- Capture all methods of an overloaded function
- Allow wider access to subfunctions and private functions
- Ensure reliability when evaluating functions
- Reduce the number of files that define your functions
- Improve performance in repeated operations
- Manipulate handles in arrays, structures, and cell arrays

This section also includes an example of using a simple function handle. See “A Simple Function Handle” on page 21-5.

Pass Function Access Information to Other Functions

You can pass a function handle as an argument in a call to another function. The handle contains access information that enables the receiving function to call the function for which the handle was constructed.

You can evaluate a function handle from within another function even if the handle’s function is not in the scope of the evaluating function. This is because the function performing the evaluation has all the information it needs within the function handle.

For the same reason, you can also evaluate a function handle even when the handle’s function is no longer on the MATLAB search path.

You must use the MATLAB `feval` command to evaluate the function in a function handle. When you pass a function handle as an argument into another function, then the function receiving the handle uses `feval` to evaluate the function handle.

Capture All Methods of An Overloaded Function

Because many MATLAB functions are overloaded, a function handle often maps to a number of code sources (e.g., built-in code, M-files), that implement the function. A function handle stores the access to all of the overloaded sources, or *methods*, that are on the MATLAB path at the time the handle is created.

When you evaluate an overloaded function handle, MATLAB follows the usual rules of selecting which method to evaluate, basing the selection on the argument types passed in the function call. See “How MATLAB Determines Which Method to Call” on page 22-67, for more information on how MATLAB selects overloaded functions.

For example, there are three built-in functions and one M-file function that define the `abs` function on the standard MATLAB path. A function handle created for the `abs` function contains access information on all four of these function sources. If you evaluate the function with an argument of the `double` type, then the built-in function that takes a `double` argument is executed.

Allow Wider Access to Subfunctions and Private Functions

By definition, all MATLAB functions have a certain scope. They are visible to other MATLAB entities within that scope, but not visible outside of it. You can invoke a function directly from another function that is within its scope, but not from a function outside that scope.

Subfunctions and private functions are, by design, limited in their visibility to other MATLAB functions. You can invoke a subfunction only by another function that is defined within the same M-file. You can invoke a private function only from a function in the directory immediately above the `\private` subdirectory.

When you create a handle to a function that has limited scope, the function handle stores all the information MATLAB needs to evaluate the function from any location in the MATLAB environment. If you create a handle to a subfunction while the subfunction is in scope, (that is, you create it from within the M-file that defines the subfunction), you can then pass the handle to code that resides outside of that M-file and evaluate the subfunction from beyond its usual scope. The similar case holds true for private functions.

Ensure Reliability When Evaluating Functions

Function handles allow you more control over what methods get executed when a function is evaluated. If you create a function handle for a function with overloaded methods, making sure that only the intended methods are within scope when the handle is created gives you control over which methods are executed when MATLAB evaluates the handle. This can isolate you from methods that might be in scope at the time of evaluation that you didn't know about.

Reduce the Number of Files That Define Your Functions

You can use function handles to help reduce the number of M-files required to define your functions. The problem with grouping a number of functions in one M-file is that this defines them as subfunctions, and thus reduces their scope in MATLAB. Using function handles to access these subfunctions removes this limitation. This enables you to group functions as you want and reduce the number of files you have to manage.

Improve Performance in Repeated Operations

MATLAB performs a lookup on a function at the time you create a function handle and then stores this access information in the handle itself. Once defined, you can use this handle in repeated evaluations without incurring the performance delay associated with function lookup each time.

Manipulate Handles in Arrays, Structures, and Cell Arrays

As a standard MATLAB data type, a function handle can be manipulated and operated on in the same manner as other MATLAB data types. You can create arrays, structures, or cell arrays of function handles. Access individual function handles within these data structures in the same way that you access elements of a numeric array or structure.

Create n-dimensional arrays of handles using either of the concatenation methods used to form other types of MATLAB arrays, `[]` or `cat`. All operations involving matrix manipulation are supported for function handles.

A Simple Function Handle

The `repmat` function is an elementary matrix function, which is defined in MATLAB with the single M-file, `repmat.m`. If you create a function handle to the `repmat` function, MATLAB stores in the handle the information it will need later to evaluate the function. Included in this information is the `repmat.m` source file path, `toolbox\matlab\elmat\repmat.m`.

Once you create a function handle, it is not affected by certain changes you might make in your MATLAB environment. For example, if you construct a handle to the `repmat` function and, later, write additional `repmat.m` methods to overload the function, the handle still *sees* only the original function. Also, if you remove the path to `repmat.m` from the search path, MATLAB is still able to locate and evaluate the function using the handle that you created prior to the path change.

Since `repmat` is not an overloaded function in this case, evaluation of the function through its handle is fairly simple. You call `feval` on the function handle, also passing any arguments the function should act upon. MATLAB executes the one function whose access information is stored in the handle.

Constructing a Function Handle

Construct a function handle in MATLAB using the *at* sign, @, before the function name. The following example creates a function handle for the `humps` function and assigns it to the variable `fhandle`.

```
fhandle = @humps;
```

Pass the handle to another function in the same way you would pass any argument. This example passes the function handle just created to `fminbnd`, which then minimizes over the interval `[0.3, 1]`.

```
x = fminbnd(fhandle, 0.3, 1)
x =
    0.6370
```

The `fminbnd` function evaluates the `@humps` function handle using `feval`. A small portion of the `fminbnd` M-file is shown below. In line 1, the `funfcn` input parameter receives the function handle, `@humps`, that was passed in. The `feval` statement, in line 113, evaluates the handle.

```
1    function [xf,fval,exitflag,output] = ...
        fminbnd(funfcn,ax,bx,options,varargin)
        .
        .
        .
113   fx = feval(funfcn,x,varargin{:});
```

Note When creating a function handle, you may only use the function *name* after the @ sign. This must not include any path information. The following syntax is invalid: `fhandle = @"\home\user4\humps`.

Maximum Length of a Function Name

Function names used in handles are unique up to 31 characters. If the function name exceeds that length, MATLAB truncates the latter part of the name.

```
fhandle = @function_name_that_exceeds_thirty_one_characters
fhandle =
    @function_name_that_exceeds_thir
```

For function handles created for Java constructors, the length of any segment of the package name or class name must not exceed 31 characters. (The term *segment* refers to any portion of the name that lies before, between, or after a dot. For example, there are three segments in `java.lang.String`.) There is no limit to the overall length of the string specifying the package and class.

The following statement is valid, even though the length of the overall package and class specifier exceeds 31 characters.

```
fhandle = @java.awt.datatransfer.StringSelection
```

Evaluating a Function Through Its Handle

Execute the target function of a function handle using the MATLAB `feval` command. The syntax for using this command with a function handle is

```
feval(fhandle, arg1, arg2, ..., argn)
```

This acts similarly to a direct call to the function represented by `fhandle`, passing arguments `arg1` through `argn`. The principal differences are:

- A function handle can be evaluated from within any function that you pass it to.
- The code source that MATLAB selects for evaluation depends upon which overloaded methods of the function were on the MATLAB path and in scope at the time the handle was constructed. (Argument types also affect method selection.) Path and scope are not considered at the time of evaluation.
- MATLAB does the work of initial function lookup at the time the function handle is constructed. This does not need to be done each time MATLAB evaluates the handle.

Note The `feval` command does not operate on nonscalar function handles. Passing a nonscalar function handle to `feval` results in an error.

Function Evaluation and Overloading

To understand the relationship between function handles and overloading, it is helpful to review, briefly, the nature of MATLAB function calls. Because of overloading, it is useful to think of a single MATLAB function as comprising a number of code sources (for example, built-in code, M-files). When you call a MATLAB function without `feval`, the choice of which source is called depends upon two factors:

- The methods that are visible on the path at the time of the call
- The classes of the arguments to the function

MATLAB evaluates function handles in a similar manner. In most cases, a function handle represents a collection of methods that overload the function.

When you evaluate a function handle using `feval`, the choice of the particular method called depends on:

- The methods that were visible on the path at the time the handle was constructed
- The classes of the arguments passed with the handle to the `feval` command

Examples of Function Handle Evaluation

This section provides two examples of how function handles are used and evaluated.

Example 1 - A Simple Function Handle

The following example defines a function, called `plot_fhandle`, that receives a function handle and data, and then performs an evaluation of the function handle on that data.

```
function x = plot_fhandle(fhandle, data)
    plot(data, feval(fhandle, data))
```

When you call `plot_fhandle` with a handle to the `sin` function and the argument shown below, the resulting evaluation produces the following plot.

```
plot_fhandle(@sin, -pi:0.01:pi)
```

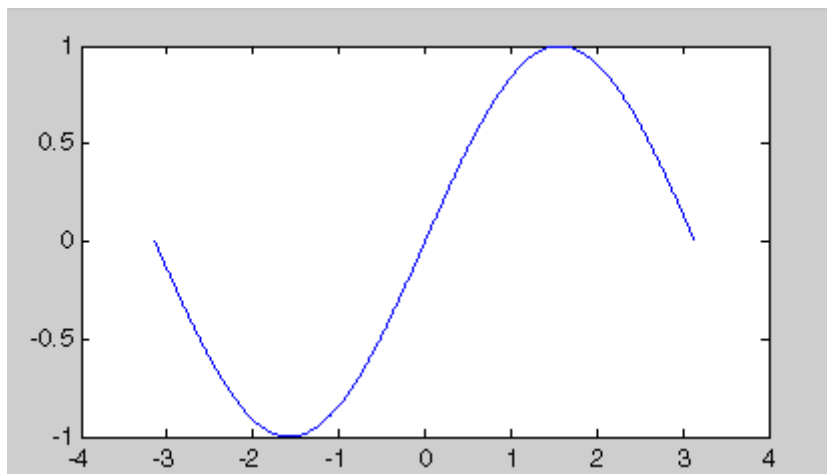

Example 2 - Function Handles and Subfunctions

The M-file in this example defines a primary function, `fitcurvedemo`, and a subfunction called `expfun`. The subfunction, by definition, is visible only within the scope of its own M-file. This, of course, means that it is available for use only by other functions within that M-file.

The author of this code would like to use `expfun` outside the confines of this one M-file. This example creates a function handle to the `expfun` subfunction, storing access information for the subfunction so that it can be called from anywhere in the MATLAB environment. The function handle is passed to `fminsearch`, which successfully evaluates the subfunction outside of its usual scope.

The code shown below defines `fitcurvedemo` and subfunction, `expfun`. Line 6 constructs a function handle to `expfun` and assigns it to the variable, `fun`. In line 16, a call to `fminsearch` passes the function handle outside the normal scope of a subfunction. The `fminsearch` function uses `feval` to evaluate the subfunction through its handle.

```
1 function Estimates = fitcurvedemo
2 % FITCURVEDEMO
3 % Fit curve to data where user chooses equation to fit.
4
5 % Define function and starting point of fitting routine.
6 fun = @expfun;
7 Starting = rand(1, 2);
8
9 % First, we create the data.
10 t = 0:.1:10;    t=t(:);    % to make 't' a column vector
11 Data = 40 * exp(-.5 * t) + randn(size(t));
12 m = [t Data];
13
14 % Now, we can call FMINSEARCH:
15 options = optimset('fminsearch'); % Use FMINSEARCH defaults
16 Estimates = fminsearch(fun, Starting, options, t, Data);
17
18 % To check the fit
19 plot(t, Data, '*')
20 hold on
21 plot(t, Estimates(1) * exp(-Estimates(2) * t), 'r')
22 xlabel('t')
```

```
23 ylabel('f(t)')
24 title(['Fitting to function ', func2str(fun)]);
25 legend('data', ['fit using ', func2str(fun)])
26 hold off
27
28 % -----
29
30 function sse = expfun(params, t, Data)
31 % Accepts curve parameters as inputs, and outputs fitting the
32 % error for the equation  $y = A * \exp(-\lambda * t)$ ;
33 A = params(1);
34 lambda = params(2);
35
36 Fitted_Curve = A .* exp(-lambda * t);
37 Error_Vector = Fitted_Curve - Data;
38
39 % When curve fitting, a typical quantity to minimize is the sum
40 % of squares error
41 sse = sum(Error_Vector .^ 2);
```

Displaying Function Handle Information

The `functions` command returns information about a function handle that might be useful for debugging. Calling `functions` on a function handle returns the function name, type, filename, and all of the methods for the function that were in scope at the time the function handle was created.

The information returned from `functions` is in the form of a MATLAB structure. The fields of this structure are listed in the following table.

Field Name	Field Description
<code>function</code>	Function name.
<code>type</code>	Function type. See the table in section, “Function Type” on page 21-14.
<code>file</code>	The file to be executed when the function handle is evaluated with a nonoverloaded data type. For built-in functions, it reads 'MATLAB built-in function.'
<code>methods</code>	All overloaded methods of the function that are bound to the function handle. This field exists only for functions of type, <code>overloaded</code> .

For example, to obtain information on a function handle for the `display` function,

```
f = functions(@display)
ans =
    function: 'display'
           type: 'overloaded'
           file: 'MATLAB built-in function'
           methods: [1x1 struct]
```

Individual fields of the structure are accessible using the dot selection notation used to access MATLAB structure fields.

```
f.type
ans =
    'overloaded'
```

The `methods` field is a separate structure containing one fieldname for each class that overloads the function. The value of each field is the path and name of the file that defines the function.

```
f.methods
ans =
    polynomial: '\home\user4\@polynom\display.m'
    inline: 'matlabroot\toolbox\matlab\funfun\@inline\display.m'
    serial: 'matlabroot\toolbox\matlab\iofun\@serial\display.m'
    avifile: 'matlabroot\toolbox\matlab\iofun\@avifile\display.m'

f.methods.polynom
ans =
    polynomial: '\home\user4\@polynom\display.m'
```

Note The `functions` command does not operate on nonscalar function handles. Passing a nonscalar function handle to `functions` results in an error.

Fields Returned by the Functions Command

The `functions` command returns a MATLAB structure with the fields `function`, `type`, `file`, and, for overloaded functions, `methods`. This section describes each of those fields.

Function Name

The `function` field is a character array that holds the name of the function corresponding to the function handle.

Function Type

The `type` field is a character array that holds one of five possible strings listed in the following table.

Function Type	Type Description
simple	Nonoverloaded MATLAB built-in or M-file, or any function for which the type cannot be determined until it is evaluated
subfunction	MATLAB subfunction
private	MATLAB private function
constructor	Constructor to a MATLAB class
overloaded	Overloaded built-in, M-file function, or constructor

The contents of the next two fields, `file` and `methods`, depend upon the function type.

Function File

The `file` field is a character array that holds one of the following:

- The string, 'MATLAB built-in function', for built-in functions
- The path and name of the file that implements the default function, for nonbuilt-in functions

The *default* function is the one function implementation that is not specialized to operate on any particular data type. Unless the arguments in the function call specify a class that has a specialized version of the function defined, it is the default function that gets called.

The example below operates on a function handle for the `deblank` function. The function has a default implementation in the `strfun` directory. This is shown in `f.file`. It also has an overloaded method in the `@cell` directory. This is shown in `f.methods.cell`.

```
f = functions(@deblank)
f =
    function: 'deblank'
    type: 'overloaded'
    file: 'matlabroot\toolbox\matlab\strfun\deblank.m'
```

```
        methods: [1x1 struct]

f.methods
ans =
    cell: 'matlabroot\toolbox\matlab\strfun\@cell\deblank.m'
```

If you evaluate the @deblank function handle with a cell argument, MATLAB calls the deblank method in the @cell directory. But, for any other argument types, MATLAB calls the default M-file shown in the file field.

Function Methods

The methods field exists only for functions of type, overloaded. This field is a separate MATLAB structure that identifies all overloaded methods that are bound to the function handle.

The structure contains one field for each method of the function handle. The field names are the classes that overload the function. Each field value is a character array holding the path and name of the source file that defines the method.

For example, a function handle for the display function may be bound to the M-files shown below. The functions command returns a methods structure having a field for each class overloading the function: polynom, inline, serial, and avifile. For each class, it shows the path and name of the method source file.

```
f = functions(@display);

f.methods
ans =
    polynom: '\home\user4\@polynom\display.m'
    inline: 'matlabroot\toolbox\matlab\funfun\@inline\display.m'
    serial: 'matlabroot\toolbox\matlab\iofun\@serial\display.m'
    avifile: 'matlabroot\toolbox\matlab\iofun\@avifile\display.m'
```

Note The set of methods returned by functions is determined at the time a function handle is created. This depends on the state of the MATLAB path and also which functions are in scope when the handle is created.

Types of Function Handles

The information returned by functions varies depending on the type of function represented by the function handle. This section explains what is returned for each type of function. The categories of function handles are:

- Simple function handles
- Overloaded function handles
- Constructor function handles
- Subfunction handles
- Private function handles

Simple Function Handles

These are handles to nonoverloaded MATLAB built-in or M-file functions. Any function handles for which the function type has not yet been determined (e.g., Java methods, nonexistent functions), also fall into this category.

Structure fields:

```
function: function name
         type: 'simple'
         file: 'MATLAB built-in function'           for built-ins
              path and name of the default M-file  for nonbuilt-ins
         (there is no methods field)
```

Examples:

Using functions on a function handle to a built-in function

```
functions(@ones)
ans =
    function: 'ones'
           type: 'simple'
           file: 'MATLAB built-in function'
```

Using functions on a function handle to a nonbuilt-in function

```
functions(@fzero)
ans =
    function: 'fzero'
           type: 'simple'
           file: 'matlabroot\toolbox\matlab\funfun\fzero.m'
```

Overloaded Function Handles

These are handles to MATLAB built-in or M-file functions that are overloaded implementations for different classes.

Structure fields:

```
function: function name
type: 'overloaded'
file: 'MATLAB built-in function'           for built-ins
      path and name of the default M-file  for nonbuilt-ins
methods: [1x1 struct]
```

Examples:

Using functions on a function handle to a built-in function

```
functions(@display)
ans =
function: 'display'
type: 'overloaded'
file: 'MATLAB built-in function'
methods: [1x1 struct]
```

Using functions on a function handle to a nonbuilt-in function

```
functions(@deblank)
ans =
function: 'deblank'
type: 'overloaded'
file: 'matlabroot\toolbox\matlab\strfun\deblank.m'
methods: [1x1 struct]
```

Constructor Function Handles

These are handles to functions that construct objects of MATLAB classes.

Structure fields:

```
function: function name
type: 'constructor'
file: path and name of the constructor M-file
(there is no methods field)
```

Example:**Using functions on a function handle to a constructor function**

```

functions(@inline)
ans =
    function: 'inline'
         type: 'constructor'
         file: 'matlabroot\toolbox\matlab\funfun\@inline\inline.m'

```

Subfunction Handles

These are handles to MATLAB subfunctions, which are functions defined within an M-file that are only visible to the primary function of that M-file. When you use functions on a subfunction handle, the file field of the return structure contains the path and name of the M-file in which the subfunction is defined.

Structure fields:

```

function: function name
         type: 'subfunction'
         file: path and name of the M-file defining the subfunction
         (there is no methods field)

```

Example:

The getLocalHandle M-file, shown below, defines a primary function and a subfunction, named subfunc.

```

% -- File GETLOCALHANDLE.M --
function subhandle = getLocalHandle()
subhandle = @subfunc;           % return handle to subfunction

function subfunc()
disp 'running subfunc'

```

A call to getLocalHandle returns a function handle to the subfunction. When you pass that handle to functions, it returns the following information.

```

fhandle = getLocalHandle;

functions(fhandle)
ans =
    function: 'subfunc'

```

```
type: 'subfunction'  
file: '\home\user4\getLocalHandle.m'
```

Private Function Handles

These are handles to MATLAB private functions, which are functions defined in a private subdirectory that are only visible to functions in the parent directory. When you use functions on a private function handle, the `file` field of the return structure contains the path and name of the M-file in the private subdirectory that defines the function.

Structure fields:

```
function: function name  
type: 'private'  
file: path and name of the M-file in \private  
(there is no methods field)
```

Example:

The `getPrivateHandle` function, shown below, returns a handle to a private function named `privatefunc`.

```
% -- File GETPRIVATEHANDLE.M --  
function privhandle = getPrivateHandle()  
privhandle = @privatefunc;    % return handle to private function
```

The following function, `privatefunc`, resides in the `\private` subdirectory.

```
% -- File \PRIVATE\PRIVATEFUNC.M --  
function privatefunc()  
disp 'running privatefunc'
```

A call to `getPrivateHandle` returns a handle to the function, `privatefunc`, defined in `\private`. When you pass that handle to functions, it returns the following information.

```
fhandle = getPrivateHandle;  
  
functions(fhandle)  
ans =  
function: 'privatefunc'  
type: 'private'  
file: '\home\user4\private\privatefunc.m'
```

Function Handle Operations

MATLAB provides two functions that enable you to convert between a function handle and a function name string. It also provides functions for testing to see if a variable holds a function handle, and for comparing function handles.

Converting Function Handles to Function Names

If you need to perform string operations, such as string comparison or display, on a function handle, you can use `func2str` to obtain the function name in string format. To convert a `sin` function handle to a string

```
fhandle = @sin;

func2str(fhandle)
ans =
    sin
```

Note The `func2str` command does not operate on nonscalar function handles. Passing a nonscalar function handle to `func2str` results in an error.

Example - Displaying the Function Name in an Error Message

The `catcherr` function shown here accepts function handle and data arguments and attempts to evaluate the function through its handle. If the function fails to execute, `catcherr` uses `fprintf` to display an error message giving the name of the failing function. The function name must be a string for `fprintf` to display it. The code derives the function name from the function handle using `func2str`.

```
function catcherr(func, data)
try
    ans = feval(func, data);
    disp('Answer is:');
    ans
catch
    fprintf('Error executing function '%s'\n', func2str(func))
end
```

The first call to `catcherr`, shown below, passes a handle to the `round` function and a valid data argument. This call succeeds and returns the expected answer. The second call passes the same function handle and an improper data type (a MATLAB structure). This time, `round` fails, causing `catcherr` to display an error message that includes the failing function name.

```
catcherr(@round, 5.432)
ans =
Answer is 5

xstruct.value = 5.432;
catcherr(@round, xstruct)
Error executing function "round"
```

Converting Function Names to Function Handles

Using the `str2func` function, you can construct a function handle from a string containing the name of a MATLAB function. To convert the string, `'sin'`, into a handle for that function

```
fh = str2func('sin')
fh =
    @sin
```

If you pass a function name string in a variable, the function that receives the variable can convert the function name to a function handle using `str2func`. The example below passes the variable, `funcname`, to function `makeHandle`, which then creates a function handle.

```
function fh = makeHandle(funcname)
fh = str2func(funcname);
% -- end of makeHandle.m file --

makeHandle('sin')
ans =
    @sin
```

You can also perform the `str2func` operation on a cell array of function name strings. In this case, `str2func` returns an array of function handles.

```
fh_array = str2func({'sin' 'cos' 'tan'})
fh_array =
    @sin    @cos    @tan
```

Example - More Flexible Parameter Checking

In the following example, the `myminbnd` function expects to receive either a function handle or string in the first argument. If you pass a string, `myminbnd` constructs a function handle from it using `str2func`, and then uses that handle in a call to `fminbnd`.

```
function myminbnd(fhandle, lower, upper)
if ischar(fhandle)
    disp 'converting function string to function handle ...'
    fhandle = str2func(fhandle);
end
fminbnd(fhandle, lower, upper)
```

Whether you call `myminbnd` with a function handle or function name string, it is able to handle the argument appropriately.

```
myminbnd('humps', 0.3, 1)
converting function string to function handle ...
ans =
    0.6370
```

Testing for Data Type

The `isa` function identifies the data type or class of a MATLAB variable or object. You can see if a variable holds a function handle by using `isa` with the `function_handle` tag. The following function tests an argument passed in to see if it is a function handle before attempting to evaluate it.

```
function evaluate_handle(arg1, arg2)
if isa(arg1, 'function_handle')
    feval(arg1, arg2);
else
    disp 'You need to pass a function handle';
end
```

Testing for Equality

You can use the `isequal` function to compare two function handles for equality. For example, you want to execute one particular method you have written for an overloaded function. You create a function handle within a confined scope so that it provides access to that method alone. The function shown below,

`test_myfun`, receives this function handle in the first argument, `arg1`, and evaluates it.

Before evaluating the handle in `arg1`, `test_myfun` checks it against another function handle that has a broader definition. This other handle, `@myfun`, provides access to all methods for the function. If the function handle in `arg1` represents more than the one intended method, an error message is displayed and the function is not evaluated.

```
function test_myfun(arg1, arg2)
if isequal(arg1, @myfun)
    disp 'Function handle holds unexpected context'
else
    feval(arg1, arg2);
end
```

Saving and Loading Function Handles

You can use the MATLAB `save` and `load` functions to save function handles to MAT files, and then load them back into your MATLAB workspace later on. This example shows an array of function handles saved to the file, `savefile`, and then restored.

```
fh_array = [@sin @cos @tan];
save savefile fh_array;
clear

load savefile
whos
    Name          Size          Bytes  Class
    fh_array      1x3             48    function_handle array
Grand total is 3 elements using 48 bytes
```

Possible Effects of Changes Made Between Save and Load

If you load a function handle that you saved in an earlier MATLAB session, the following conditions could cause unexpected behavior:

- Any of the M-files that define the function have been moved, and thus no longer exist on the path stored in the handle.
- You load the function handle into an environment different from that in which it was saved. For example, the source for the function either doesn't exist or is located in a different directory than on the system on which the handle was saved.
- You have overloaded the function with additional methods since the save was done. The function handle you just loaded doesn't know about the new methods.

In the first two cases, the function handle is now invalid, since it no longer maps to any existing source code. Although the handle is invalid, MATLAB still performs the load successfully and without displaying a warning. An attempt to evaluate the handle however results in an error.

Handling Error Conditions

The following are error conditions associated with the use of function handles.

Handles to Nonexistent Functions

If you create a handle to a function that does not exist, MATLAB catches the error when the handle is evaluated by `feval`. MATLAB allows you to assign an invalid handle and use it in such operations as `func2str`, but will catch and report an error when you attempt to use it in a runtime operation. For example,

```
fhandle = @no_such_function;

func2str(fhandle)
ans =
no_such_function

feval(fhandle)
??? Error using ==> feval
Undefined function 'no_such_function'.
```

Including Path In the Function Handle Constructor

You construct a function handle using the `@` sign, `@`, or the `str2func` function. In either case, you specify the function using only the simple function name. The function name cannot include path information. Either of the following successfully creates a handle to the `deblank` function.

```
fhandle = @deblank;
fhandle = str2func('deblank');
```

The next example includes the path to `deblank.m`, and thus returns an error.

```
fhandle = str2func(which('deblank'))
??? Error using ==> str2func
Invalid function name
'matlabroot\toolbox\matlab\strfun\deblank.m'.
```

Evaluating a Nonscalar Function Handle

The `feval` function evaluates function handles only if they are scalar. Calling `feval` with a nonscalar function handle results in an error.

```
feval(@sin @cos, 5)
??? Error using ==> feval
Function_handle argument must be scalar.
```

Historical Note - Evaluating Function Names

Evaluating a function by means of a function handle replaces the former MATLAB mechanism of evaluating a function through a string containing the function name. For example, of the following two lines of code that evaluate the `humps` function, the second supersedes the first and is considered to be the preferable mechanism to use.

```
feval('humps', 0.5674);      % uses a function name string
feval(@humps, 0.5674);      % uses a function handle
```

To support backward compatibility, `feval` still accepts a function name string as a first argument and evaluates the function named in the string. However, function handles offer you the additional performance, reliability, and source file control benefits listed in the section “Benefits of Using Function Handles” on page 21-3.

MATLAB Classes and Objects

Classes and Objects: An Overview	22-3
Designing User Classes in MATLAB	22-9
Overloading Operators and Functions	22-21
Example - A Polynomial Class	22-24
Building on Other Classes	22-35
Example - Assets and Asset Subclasses	22-38
Example - The Portfolio Container	22-54
Saving and Loading Objects	22-60
Example - Defining saveobj and loadobj for Portfolio	22-61
Object Precedence	22-65
How MATLAB Determines Which Method to Call . .	22-67

This chapter describes how to define classes in MATLAB. Classes and objects enable you to add new data types and new operations to MATLAB. The *class* of a variable describes the structure of the variable and indicates the kinds of operations and functions that can apply to the variable. An *object* is an instance of a particular class. The phrase *object-oriented programming* describes an approach to writing programs that emphasizes the use of classes and objects.

The following topics and examples are presented in this chapter:

- “Classes and Objects: An Overview”
- “Designing User Classes in MATLAB”
- “Overloading Operators and Functions”
- “Example - A Polynomial Class”
- “Building on Other Classes”
- “Example - Assets and Asset Subclasses”
- “Example - The Portfolio Container”
- “Saving and Loading Objects”
- “Example - Defining saveobj and loadobj for Portfolio”
- “Object Precedence”
- “How MATLAB Determines Which Method to Call”

Classes and Objects: An Overview

You can view classes as new data types having specific behaviors defined for the class. For example, a polynomial class might redefine the addition operator (+) so that it correctly performs the operation of addition on polynomials. Operations defined to work with objects of a particular class are known as *methods* of that class.

You can also view classes as new items that you can treat as single entities. An example is an arrow object that MATLAB can display on graphs (perhaps composed of MATLAB line and patch objects) and that has properties like a Handle Graphics object. You can create an arrow simply by instantiating the arrow class.

You can add classes to your MATLAB environment by specifying a MATLAB structure that provides data storage for the object and creating a class directory containing M-files that operate on the object. These M-files contain the methods for the class. The class directory can also include functions that define the way various MATLAB operators, including arithmetic operations, subscript referencing, and concatenation, apply to the objects. Redefining how a built-in operator works for your class is known as *overloading* the operator.

Features of Object-Oriented Programming

When using well-designed classes, object-oriented programming can significantly increase code reuse and make your programs easier to maintain and extend. Programming with classes and objects differs from ordinary structured programming in these important ways:

- **Function and operator overloading.** You can create methods that override existing MATLAB functions. When you call a function with a user-defined object as an argument, MATLAB first checks to see if there is a method defined for the object's class. If there is, MATLAB calls it, rather than the normal MATLAB function.
- **Encapsulation of data and methods.** Object properties are not visible from the command line; you can access them only with class methods. This protects the object properties from operations that are not intended for the object's class.
- **Inheritance.** You can create class hierarchies of parent and child classes in which the child class inherits data fields and methods from the parent. A

child class can inherit from one parent (*single inheritance*) or many parents (*multiple inheritance*). Inheritance can span one or more generations. Inheritance enables sharing common parent functions and enforcing common behavior amongst all child classes.

- **Aggregation.** You can create classes using *aggregation*, in which an object contains other objects. This is appropriate when an object type is part of another object type. For example, a savings account object might be a part of a financial portfolio object.

MATLAB Data Class Hierarchy

All MATLAB data types are designed to function as classes in object-oriented programming. The diagram below shows the fourteen fundamental data types (or classes) defined in MATLAB. You can add new data types to MATLAB by extending the class hierarchy.

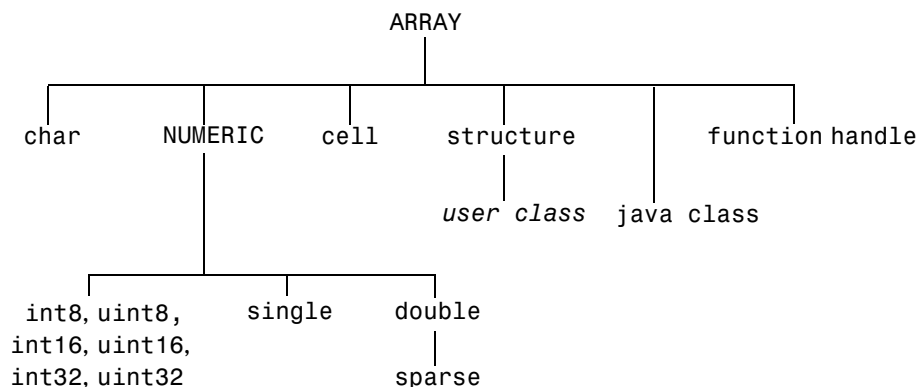

The diagram shows a *user class* that inherits from the structure class. All classes that you create are structure based since this is the point in the class hierarchy where you can insert your own classes. (For more information about MATLAB data types, see the section on “Data Types.”)

Creating Objects

You create an object by calling the class constructor and passing it the appropriate input arguments. In MATLAB, constructors have the same name as the class name. For example, the statement,

```
p = polynom([1 0 -2 -5]);
```

creates an object named `p` belonging to the class `polynom`. Once you have created a `polynom` object, you can operate on the object using methods that are defined for the `polynom` class. See “Example - A Polynomial Class” on page 22-24 for a description of the `polynom` class.

Invoking Methods on Objects

Class methods are M-file functions that take an object as one of the input arguments. The methods for a specific class must be placed in the class directory for that class (the `@class_name` directory). This is the first place that MATLAB looks to find a class method.

The syntax for invoking a method on an object is similar to a function call. Generally, it looks like

```
[out1,out2,...] = method_name(object,arg1,arg2,...);
```

For example, suppose a user-defined class called `polynom` has a `char` method defined for the class. This method converts a `polynom` object to a character string and returns the string. This statement calls the `char` method on the `polynom` object `p`.

```
s = char(p);
```

Using the `class` function, you can confirm that the returned value `s` is a character string.

```
class(s)

ans =

    char

s

s =

    x^3-2*x-5
```

You can use the `methods` command to produce a list of all of the methods that are defined for a class.

Private Methods

Private methods can be called only by other methods of their class. You define private methods by placing the associated M-files in a `private` subdirectory of the `@class_name` directory. In the example,

```
@class_name/private/update_obj.m
```

the method `update_obj` has scope only within the `class_name` class. This means that `update_obj` can be called by any method that is defined in the `@class_name` directory, but it cannot be called from the MATLAB command line or by methods outside of the class directory, including parent methods.

Private methods and private functions differ in that private methods (in fact all methods) have an object as one of their input arguments and private functions do not. You can use private functions as helper functions, such as described in the next section.

Helper Functions

In designing a class, you may discover the need for functions that perform support tasks for the class, but do not directly operate on an object. These functions are called *helper functions*. A helper function can be a subfunction in a class method file or a private function. When determining which version of a particular function to call, MATLAB looks for these functions in the order listed above. For more information about the order in which MATLAB calls functions and methods, see “How MATLAB Determines Which Method to Call” on page 22-67.

Debugging Class Methods

You can use the MATLAB debugging commands with object methods in the same way that you use them with other M-files. The only difference is that you need to include the class directory name before the method name in the command call, as shown in this example using `dbstop`.

```
dbstop @polynom/char
```

While debugging a class method, you have access to all methods defined for the class, including inherited methods, private methods, and private functions.

Changing Class Definition

If you change the class definition, such as the number or names of fields in a class, you must issue a

```
clear classes
```

command to propagate the changes to your MATLAB session. This command also clears all objects from the workspace. See the `clear` command help entry for more information.

Setting Up Class Directories

The M-files defining the methods for a class are collected together in a directory referred to as the class directory. The directory name is formed with the class name preceded by the character `@`. For example, one of the examples used in this chapter is a class involving polynomials in a single variable. The name of the class, and the name of the class constructor, is `polynom`. The M-files defining a polynomial class would be located in directory with the name `@polynom`.

The class directories are subdirectories of directories on the MATLAB search path, but are not themselves on the path. For instance, the new `@polynom` directory could be a subdirectory of MATLAB's working directory or your own personal directory that has been added to the search path.

Adding the Class Directory to the MATLAB Path

After creating the class directory, you need to update the MATLAB path so that MATLAB can locate the class source files. The class directory should not be directly on the MATLAB path. Instead, you should add the parent directory to the MATLAB path. For example, if the `@polynom` class directory is located at

```
c:\my_classes\@polynom
```

you add the class directory to the MATLAB path with the `addpath` command

```
addpath c:\my_classes;
```

If you create a class directory with the same name as another class, MATLAB treats the two class directories as a single directory when locating class methods. For more information, see “How MATLAB Determines Which Method to Call” on page 22-67.

Data Structure

One of the first steps in the design of a new class is the choice of the data structure to be used by the class. Objects are stored in MATLAB structures. The fields of the structure, and the details of operations on the fields, are visible only within the methods for the class. The design of the appropriate data structure can affect the performance of the code.

Tips for C++ and Java Programmers

If you are accustomed to programming in other object-oriented languages, such as C++ or Java, you will find that the MATLAB programming language differs from these languages in some important ways:

- In MATLAB, method dispatching is not syntax based, as it is in C++ and Java. When the argument list contains objects of equal precedence, MATLAB uses the left-most object to select the method to call.
- In MATLAB, there is no equivalent to a destructor method. To remove an object from the workspace, use the `clear` function.
- Construction of MATLAB data types occurs at runtime rather than compile time. You register an object as belonging to a class by calling the `class` function.
- When using inheritance in MATLAB, the inheritance relationship is established in the child class by creating the parent object, and then calling the `class` function. For more information on writing constructors for inheritance relationships, see “Building on Other Classes” on page 22-35.
- When using inheritance in MATLAB, the child object contains a parent object in a property with the name of the parent class.
- In MATLAB, there is no passing of variables by reference. When writing methods that update an object, you must pass back the updated object and use an assignment statement. For instance, this call to the `set` method updates the `name` field of the object `A` and returns the updated object.

```
A = set(A, 'name', 'John Smith');
```
- In MATLAB, there is no equivalent to an abstract class.
- In MATLAB, there is no equivalent to the C++ scoping operator.
- In MATLAB, there is no virtual inheritance or virtual base classes.
- In MATLAB, there is no equivalent to C++ templates.

Designing User Classes in MATLAB

This section discusses how to approach the design of a class and describes the basic set of methods that should be included in a class.

The MATLAB Canonical Class

When you design a MATLAB class, you should include a standard set of methods that enable the class to behave in a consistent and logical way within the MATLAB environment. Depending on the nature of the class you are defining, you may not need to include all of these methods and you may include a number of other methods to realize the class's design goals.

This table lists the basic methods included in MATLAB classes.

Class Method	Description
class constructor	Creates an object of the class
display	Called whenever MATLAB displays the contents of an object (e.g., when an expression is entered without terminating with a semicolon)
set and get	Accesses class properties
subsref and subsasgn	Enables indexed reference and assignment for user objects
end	Supports end syntax in indexing expressions using an object; e.g., A(1:end)
subsindex	Supports using an object in indexing expressions
converters like double and char	Methods that convert an object to a MATLAB data type

The following sections discuss the implementation of each type of method, as well as providing references to examples used in this chapter.

The Class Constructor Method

The @ directory for a particular class must contain an M-file known as the *constructor* for that class. The name of the constructor is the same as the name of the directory (excluding the @ prefix and .m extension) that defines the name of the class. The constructor creates the object by initializing the data structure and instantiating an object of the class.

Guidelines for Writing a Constructor

Class constructors must perform certain functions so that objects behave correctly in the MATLAB environment. In general, a class constructor must handle three possible combinations of input arguments:

- No input arguments
- An object of the same class as an input argument
- The input arguments used to create an object of the class (typically data of some kind)

No Input Arguments. If there are no input arguments, the constructor should create a default object. Since there are no inputs, you have no data from which to create the object, so you simply initialize the object's data structures with empty or default values, call the `class` function to instantiate the object, and return the object as the output argument. Support for this syntax is required for two reasons:

- When loading objects into the workspace, the `load` function calls the class constructor with no arguments.
- When creating arrays of objects, MATLAB calls the class constructor to add objects to the array.

Object Input Argument. If the first input argument in the argument list is an object of the same class, the constructor should simply return the object. Use the `isa` function to determine if an argument is a member of a class. See "Overloading the + Operator" on page 22-29 for an example of a method that uses this constructor syntax.

Data Input Arguments. If the input arguments exist and are not objects of the same class, then the constructor creates the object using the input data. Of course, as in any function, you should perform proper argument checking in your constructor function. A typical approach is to use a `varargin` input

argument and a switch statement to control program flow. This provides an easy way to accommodate the three cases: no inputs, object input, or the data inputs used to create an object.

It is in this part of the constructor that you assign values to the object's data structure, call the `class` function to instantiate the object, and return the object as the output argument. If necessary, place the object in an object hierarchy using the `superiorto` and `inferiorto` functions.

Using the class Function in Constructors

Within a constructor method, you use the `class` function to associate an object structure with a particular class. This is done using an internal class tag that is only accessible using the `class` and `isa` functions. For example, this call to the `class` function identifies the object `p` to be of type `polynom`.

```
p = class(p, 'polynom');
```

Examples of Constructor Methods

See the following sections for examples of constructor methods:

- “The Polynom Constructor Method” on page 22-24
- “The Asset Constructor Method” on page 22-39
- “The Stock Constructor Method” on page 22-46
- “The Portfolio Constructor Method” on page 22-55

Identifying Objects Outside the Class Directory

The `class` and `isa` functions used in constructor methods can also be used outside of the class directory. The expression

```
isa(a, 'class_name');
```

checks whether `a` is an object of the specified class. For example, if `p` is a `polynom` object, each of the following expressions is true.

```
isa(pi, 'double');  
isa('hello', 'char');  
isa(p, 'polynom');
```

Outside of the class directory, the `class` function takes only one argument (it is only within the constructor that `class` can have more than one argument).

The expression

```
class(a)
```

returns a string containing the class name of `a`. For example,

```
class(pi),  
class('hello'),  
class(p)
```

return

```
'double',  
'char',  
'polynom'
```

Use the `whos` function to see what objects are in the MATLAB workspace.

```
whos
```

Name	Size	Bytes	Class
p	1x1	156	polynom object

The display Method

MATLAB calls a method named `display` whenever an object is the result of a statement that is not terminated by a semicolon. For example, creating the variable `a`, which is a double, calls MATLAB's `display` method for doubles.

```
a = 5  
  
a =  
  
5
```

You should define a `display` method so MATLAB can display values on the command line when referencing objects from your class. In many classes, `display` can simply print the variable name, and then use the `char` converter method to print the contents or value of the variable, since MATLAB displays output as strings. You must define the `char` method to convert the object's data to a character string.

Examples of display Methods

See the following sections for examples of display methods:

- “The Polynom display Method” on page 22-28
- “The Asset display Method” on page 22-44
- “The Stock display Method” on page 22-52
- “The Portfolio display Method” on page 22-56

Accessing Object Data

You need to write methods for your class that provide access to an object’s data. Accessor methods can use a variety of approaches, but all methods that change object data always accept an object as an input argument and return a new object with the data changed. This is necessary because MATLAB does not support passing arguments by reference (i.e., pointers). Functions can change only their private, temporary copy of an object. Therefore, to change an existing object, you must create a new one, and then replace the old one.

The following sections provide more detail about implementation techniques for the set, get, subsasgn, and subsref methods.

The set and get Methods

The set and get methods provide a convenient way to access object data in certain cases. For example, suppose you have created a class that defines an arrow object that MATLAB can display on graphs (perhaps composed of existing MATLAB line and patch objects).

To produce a consistent interface, you could define set and get methods that operate on arrow objects the way the MATLAB set and get functions operate on built-in graphics objects. The set and get verbs convey what operations they perform, but insulate the user from the internals of the object.

Examples of set and get Methods

See the following sections for examples of set and get methods:

- “The Asset get Method” on page 22-41 and “The Asset set Method” on page 22-41
- “The Stock get Method” on page 22-48 and “The Stock set Method” on page 22-48

Property Name Methods

As an alternative to a general set method, you can write a method to handle the assignment of an individual property. The method should have the same name as the property name.

For example, if you defined a class that creates objects representing employee data, you might have a field in an employee object called `salary`. You could then define a method called `salary.m` that takes an employee object and a value as input arguments and returns the object with the specified value set.

Indexed Reference Using `subsref` and `subsasgn`

User classes implement new data types in MATLAB. It is useful to be able to access object data via an indexed reference, as is possible with MATLAB's built-in data types. For example, if `A` is an array of class `double`, `A(i)` returns the i^{th} element of `A`.

As the class designer, you can decide what an index reference to an object means. For example, suppose you define a class that creates polynomial objects and these objects contain the coefficients of the polynomial.

An indexed reference to a polynomial object,

`p(3)`

could return the value of the coefficient of x^3 , the value of the polynomial at $x = 3$, or something different depending on the intended design.

You define the behavior of indexing for a particular class by creating two class methods – `subsref` and `subsasgn`. MATLAB calls these methods whenever a subscripted reference or assignment is made on an object from the class. If you do not define these methods for a class, indexing is undefined for objects of this class.

In general, the rules for indexing objects are the same as the rules for indexing structure arrays. For details, see “Structures” on page 20-4.

Handling Subscripted Reference

The use of a subscript or field designator with an object on the right-hand side of an assignment statement is known as a *subscripted reference*. MATLAB calls a method named `subsref` in these situations. Object subscripted references can be of three forms – an array index, a cell array index, and a structure field

name:

```
A(I)
A{I}
A.field
```

Each of these results in a call by MATLAB to the `subsref` method in the class directory. MATLAB passes two arguments to `subsref`.

```
B = subsref(A,S)
```

The first argument is the object being referenced. The second argument, `S`, is a structure array with two fields:

- `S.type` is a string containing `'()''`, `'{}'`, or `'.'` specifying the subscript type. The parentheses represent a numeric array; the curly braces, a cell array; and the dot, a structure array.
- `S.subs` is a cell array or string containing the actual subscripts. A colon used as a subscript is passed as the string `':'`.

For instance, the expression

```
A(1:2,:)
```

causes MATLAB to call `subsref(A,S)`, where `S` is a 1-by-1 structure with

```
S.type = '()'
S.subs = {1:2, ':'}
```

Similarly, the expression

```
A{1:2}
```

uses

```
S.type = '{}'
```

```
S.subs = {1:2}
```

The expression

```
A.field
```

calls `subsref(A,S)` where

```
S.type = '.'
S.subs = 'field'
```

These simple calls are combined for more complicated subscripting expressions. In such cases, `length(S)` is the number of subscripting levels. For example,

```
A(1,2).name(3:4)
```

calls `subsref(A,S)`, where `S` is a 3-by-1 structure array with the values:

```
S(1).type = '()'      S(2).type = '.'      S(3).type = '()'
S(1).subs = '{1,2}'  S(2).subs = 'name'    S(3).subs = '{3:4}'
```

How to Write `subsref`

The `subsref` method must interpret the subscripting expressions passed in by MATLAB. A typical approach is to use the `switch` statement to determine the type of indexing used and to obtain the actual indices. The following three code fragments illustrate how to interpret the input arguments. In each case, the function must return the value `B`.

For an array index:

```
switch S.type
case '()'
    B = A(S.subs{:});
end
```

For a cell array:

```
switch S.type
case '{}'
    B = A(S.subs{:}); % A is a cell array
end
```

For a structure array:

```
switch S.type
case '.'
    switch S.subs
    case 'field1'
        B = A.field1;
    case 'field2'
        B = A.field2;
    end
end
```

Examples of the subsref Method

See the following sections for examples of the subsref method:

- “The Polynom subsref Method” on page 22-28
- “The Asset subsref Method” on page 22-42
- “The Stock subsref Method” on page 22-49
- “The Portfolio subsref Method” on page 22-64

Handling Subscripted Assignment

The use of a subscript or field designator with an object on the left-hand side of an assignment statement is known as a *subscripted assignment*. MATLAB calls a method named `subsasgn` in these situations. Object subscripted assignment can be of three forms – an array index, a cell array index, and a structure field name.

```
A(I) = B
A{I} = B
A.field = B
```

Each of these results in a call to `subsasgn` of the form

```
A = subsasgn(A,S,B)
```

The first argument, `A`, is the object being referenced. The second argument, `S`, has the same fields as those used with `subsref`. The third argument, `B`, is the new value.

Examples of the subsasgn Method

See the following sections for examples of the `subsasgn` method:

- “The Asset subsasgn Method” on page 22-43
- “The Stock subsasgn Method” on page 22-51

Object Indexing Within Methods

If a subscripted reference is made within a class method, MATLAB uses its built-in `subsref` function to access data within the method’s own class. If the method accesses data from another class, MATLAB calls the overloaded `subsref` function in that class. The same holds true for subscripted assignment and `subsasgn`.

The following example shows a method, `testref`, that is defined in the class, `employee`. This method makes a reference to a field, `address`, in an object of its own class. For this, MATLAB uses the built-in `subsref` function. It also references the same field in another class, this time using the overloaded `subsref` of that class.

```
% ---- EMPLOYEE class method: testref.m ----  
function testref(myclass,otherclass)  
  
myclass.address           % use built-in subsref  
otherclass.address       % use overloaded subsref
```

The example creates an employee object and a company object.

```
empl = employee('Johnson','Chicago');  
comp = company('The MathWorks','Natick');
```

The employee class method, `testref`, is called. MATLAB uses an overloaded `subsref` only to access data outside of the method's own class.

```
testref(empl,comp)  
  
ans =                               % built-in subsref was called  
  
Chicago  
  
ans =                               % @company\subsref was called  
  
Executing @company\subsref ...  
  
Natick
```

Defining end Indexing for an Object

When you use `end` in an object indexing expression, MATLAB calls the object's `end` class method. If you want to be able to use `end` in indexing expressions involving objects of your class, you must define an `end` method for your class.

The `end` method has the calling sequence

```
end(a,k,n)
```

where `a` is the user object, `k` is the index in the expression where the `end` syntax is used, and `n` is the total number of indices in the expression.

For example, consider the expression

```
A(end-1, :)
```

MATLAB calls the `end` method defined for the object `A` using the arguments

```
end(A, 1, 2)
```

That is, the `end` statement occurs in the first index element and there are two index elements. The class method for `end` must then return the index value for the last element of the first dimension. When you implement the `end` method for your class, you must ensure it returns a value appropriate for the object.

Indexing an Object with Another Object

When MATLAB encounters an object as an index, it calls the `subsindex` method defined for the object. For example, suppose you have an object `a` and you want to use this object to index into another object `b`.

```
c = b(a);
```

A `subsindex` method might do something as simple as convert the object to double format to be used as an index, as shown in this sample code.

```
function d = subsindex(a)
%SUBSINDEX
% convert the object a to double format to be used
% as an index in an indexing expression
d = double(a);
```

`subsindex` values are 0-based, not 1-based.

Converter Methods

A converter method is a class method that has the same name as another class, such as `char` or `double`. Converter methods accept an object of one class as input and return an object of another class. Converters enable you to:

- Use methods defined for another class
- Ensure that expressions involving objects of mixed class types execute properly

A converter function call is of the form

```
b = class_name(a)
```

where `a` is an object of a class other than `class_name`. In this case, MATLAB looks for a method called `class_name` in the class directory for object `a`. If the input object is already of type `class_name`, then MATLAB calls the constructor, which just returns the input argument.

Examples of Converter Methods

See the following sections for examples of converter methods:

- “The Polynom to Double Converter” on page 22-25
- “The Polynom to Char Converter” on page 22-26

Overloading Operators and Functions

In many cases, you may want to change the behavior of MATLAB's operators and functions for cases when the arguments are objects. You can accomplish this by *overloading* the relevant functions. Overloading enables a function to handle different types and numbers of input arguments and perform whatever operation is appropriate for the highest-precedence object. See “Object Precedence” on page 22-65 for more information on object precedence.

Overloading Operators

Each built-in MATLAB operator has an associated function name (e.g., the + operator has an associated `plus.m` function). You can overload any operator by creating an M-file with the appropriate name in the class directory. For example, if either `p` or `q` is an object of type `class_name`, the expression

$$p + q$$

generates a call to a function `@class_name/plus.m`, if it exists. If `p` and `q` are both objects of different classes, then MATLAB applies the rules of precedence to determine which method to use.

Examples of Overloaded Operators

See the following sections for examples of overloaded operators:

- “Overloading the + Operator” on page 22-29
- “Overloading the – Operator” on page 22-30
- “Overloading the * Operator” on page 22-30

The following table lists the function names for most of MATLAB's operators.

Operation	M-File	Description
<code>a + b</code>	<code>plus(a,b)</code>	Binary addition
<code>a - b</code>	<code>minus(a,b)</code>	Binary subtraction
<code>-a</code>	<code>uminus(a)</code>	Unary minus
<code>+a</code>	<code>uplus(a)</code>	Unary plus
<code>a.*b</code>	<code>times(a,b)</code>	Element-wise multiplication
<code>a*b</code>	<code>mtimes(a,b)</code>	Matrix multiplication
<code>a./b</code>	<code>rdivide(a,b)</code>	Right element-wise division
<code>a.\b</code>	<code>ldivide(a,b)</code>	Left element-wise division
<code>a/b</code>	<code>mrdivide(a,b)</code>	Matrix right division
<code>a\b</code>	<code>mldivide(a,b)</code>	Matrix left division
<code>a.^b</code>	<code>power(a,b)</code>	Element-wise power
<code>a^b</code>	<code>mpower(a,b)</code>	Matrix power
<code>a < b</code>	<code>lt(a,b)</code>	Less than
<code>a > b</code>	<code>gt(a,b)</code>	Greater than
<code>a <= b</code>	<code>le(a,b)</code>	Less than or equal to
<code>a >= b</code>	<code>ge(a,b)</code>	Greater than or equal to
<code>a ~= b</code>	<code>ne(a,b)</code>	Not equal to
<code>a == b</code>	<code>eq(a,b)</code>	Equality
<code>a & b</code>	<code>and(a,b)</code>	Logical AND
<code>a b</code>	<code>or(a,b)</code>	Logical OR
<code>~a</code>	<code>not(a)</code>	Logical NOT

Operation	M-File	Description
a:d:b a:b	colon(a,d,b) colon(a,b)	Colon operator
a'	ctranspose(a)	Complex conjugate transpose
a.'	transpose(a)	Matrix transpose
command window output	display(a)	Display method
[a b]	horz- cat(a,b,...)	Horizontal concatenation
[a; b]	vert- cat(a,b,...)	Vertical concatenation
a(s1,s2,...sn)	subsref(a,s)	Subscripted reference
a(s1,...,sn) = b	subsasgn(a,s,b)	Subscripted assignment
b(a)	subsindex(a)	Subscript index

Overloading Functions

You can overload any function by creating a function of the same name in the class directory. When a function is invoked on an object, MATLAB always looks in the class directory before any other location on the search path. To overload the `plot` function for a class of objects, for example, simply place your version of `plot.m` in the appropriate class directory.

Examples of Overloaded Functions

See the following sections for examples of overloaded functions:

- “Overloading Functions for the Polynom Class” on page 22-31
- “The Portfolio `pie3` Method” on page 22-57

Example - A Polynomial Class

This example implements a MATLAB data type for polynomials by defining a new class called `polynom`. The class definition specifies a structure for data storage and defines a directory (`@polynom`) of methods that operate on `polynom` objects.

Polynom Data Structure

The `polynom` class represents a polynomial with a row vector containing the coefficients of powers of the variable, in decreasing order. Therefore, a `polynom` object `p` is a structure with a single field, `p.c`, containing the coefficients. This field is accessible only within the methods in the `@polynom` directory.

Polynom Methods

To create a class that is well behaved within the MATLAB environment and provides useful functionality for a polynomial data type, the `polynom` class implements the following methods:

- A constructor method `polynom.m`
- A `polynom` to double converter
- A `polynom` to char converter
- A `display` method
- A `subsref` method
- Overloaded `+`, `-`, and `*` operators
- Overloaded `roots`, `polyval`, `plot`, and `diff` functions

The Polynom Constructor Method

Here is the `polynom` class constructor, `@polynom/polynom.m`.

```
function p = polynom(a)
%POLYNOM Polynomial class constructor.
%   p = POLYNOM(v) creates a polynomial object from the vector v,
%   containing the coefficients of descending powers of x.
if nargin == 0
    p.c = [];
    p = class(p,'polynom');
```

```
elseif isa(a,'polynom')
    p = a;
else
    p.c = a(:)';
    p = class(p,'polynom');
end
```

Constructor Calling Syntax

You can call the `polynom` constructor method with one of three different arguments:

- **No Input Argument** – If you call the constructor function with no arguments, it returns a `polynom` object with empty fields.
- **Input Argument is an Object** – If you call the constructor function with an input argument that is already a `polynom` object, MATLAB returns the input argument. The `isa` function (pronounced “is a”) checks for this situation.
- **Input Argument is a coefficient vector** – If the input argument is a variable that is not a `polynom` object, reshape it to be a row vector and assign it to the `.c` field of the object’s structure. The `class` function creates the `polynom` object, which is then returned by the constructor.

An example use of the `polynom` constructor is the statement

```
p = polynom([1 0 -2 -5])
```

This creates a polynomial with the specified coefficients.

Converter Methods for the Polynomial Class

A converter method converts an object of one class to an object of another class. Two of the most important converter methods contained in MATLAB classes are `double` and `char`. Conversion to `double` produces MATLAB’s traditional matrix, although this may not be appropriate for some classes. Conversion to `char` is useful for producing printed output.

The Polynomial to Double Converter

The `double` converter method for the `polynom` class is a very simple M-file, `@polynom/double.m`, which merely retrieves the coefficient vector.

```
function c = double(p)
% POLYNOM/DOUBLE Convert polynom object to coefficient vector.
% c = DOUBLE(p) converts a polynomial object to the vector c
% containing the coefficients of descending powers of x.
c = p.c;
```

On the object p,

```
p = polynom([1 0 -2 -5])
```

the statement

```
double(p)
```

returns

```
ans =
     1     0    -2    -5
```

The Polynom to Char Converter

The converter to char is a key method because it produces a character string involving the powers of an independent variable, x . Therefore, once you have specified x , the string returned is a syntactically correct MATLAB expression, which you can then evaluate.

Here is @polynom/char.m.

```
function s = char(p)
% POLYNOM/CHAR
% CHAR(p) is the string representation of p.c
if all(p.c == 0)
    s = '0';
else
    d = length(p.c) - 1;
    s = [];
    for a = p.c;
        if a ~= 0;
            if ~isempty(s)
                if a > 0
                    s = [s ' + '];
                else
                    s = [s ' - '];
                    a = -a;
                end
            end
        end
    end
end
```



```

        end
    end
    if a ~= 1 | d == 0
        s = [s num2str(a)];
        if d > 0
            s = [s '*'];
        end
    end
    if d >= 2
        s = [s 'x^' int2str(d)];
    elseif d == 1
        s = [s 'x'];
    end
end
end
d = d - 1;
end
end

```

Evaluating the Output

If you create the polynomial object `p`

```
p = polynom([1 0 -2 -5]);
```

and then call the `char` method on `p`

```
char(p)
```

MATLAB produces the result

```
ans =
    x^3 - 2*x - 5
```

The value returned by `char` is a string that you can pass to `eval` once you have defined a scalar value for `x`. For example,

```
x = 3;
eval(char(p))
```

```
ans =
    16
```

See “The Polynom `subsref` Method” on page 22-28 for a better method to evaluate the polynomial.

The Polynom display Method

Here is `@polynom/display.m`. This method relies on the `char` method to produce a string representation of the polynomial, which is then displayed on the screen. This method produces output that is the same as standard MATLAB output. That is, the variable name is displayed followed by an equal sign, then a blank line, then a new line with the value.

```
function display(p)
% POLYNOM/DISPLAY Command window display of a polynom
disp(' ');
disp([inputname(1), ' = ']);
disp(' ');
disp([' ' char(p)])
disp(' ');
```

The statement

```
p = polynom([1 0 -2 -5])
```

creates a polynomial object. Since the statement is not terminated with a semicolon, the resulting output is

```
p =
      x^3 - 2*x - 5
```

The Polynom subsref Method

Suppose the design of the polynomial class specifies that a subscripted reference to a polynomial object causes the polynomial to be evaluated with the value of the independent variable equal to the subscript. That is, for a polynomial object `p`,

```
p = polynom([1 0 -2 -5]);
```

the following subscripted expression returns the value of the polynomial at $x = 3$ and $x = 4$.

```
p([3 4])
ans =
      16      51
```

subsref Implementation Details

This implementation takes advantage of the `char` method already defined in the `polynom` class to produce an expression that can then be evaluated.

```
function b = subsref(a,s)
% SUBSREF
switch s.type
case '('
    ind = s.subs{:};
    for k = 1:length(ind)
        b(k) = eval(strrep(char(a),'x',num2str(ind(k))));
    end
otherwise
    error('Specify value for x as p(x)')
end
```

Once the polynomial expression has been generated by the `char` method, the `strrep` function is used to swap the passed in value for the character `x`. The `eval` function then evaluates the expression and returns the value in the output argument.

Overloading Arithmetic Operators for `polynom`

Several arithmetic operations are meaningful on polynomials and should be implemented for the `polynom` class. When overloading arithmetic operators, keep in mind what data types you want to operate on. In this section, the `plus`, `minus`, and `mtimes` methods are defined for the `polynom` class to handle addition, subtraction, and multiplication on `polynom/polynom` and `polynom/double` combinations of operands.

Overloading the `+` Operator

If either `p` or `q` is a `polynom`, the expression

$$p + q$$

generates a call to a function `@polynom/plus.m`, if it exists (unless `p` or `q` is an object of a higher precedence, as described in “Object Precedence” on page 22-65).

The following M-file redefines the + operator for the polynom class.

```
function r = plus(p,q)
% POLYNOM/PLUS Implement p + q for polynoms.
p = polynom(p);
q = polynom(q);
k = length(q.c) - length(p.c);
r = polynom([zeros(1,k) p.c] + [zeros(1,-k) q.c]);
```

The function first makes sure that both input arguments are polynomials. This ensures that expressions such as

$p + 1$

that involve both a polynomial and a double, work correctly. The function then accesses the two coefficient vectors and, if necessary, pads one of them with zeros to make them the same length. The actual addition is simply the vector sum of the two coefficient vectors. Finally, the function calls the `polynom` constructor a third time to create the properly typed result.

Overloading the – Operator

You can implement the overloaded minus operator (-) using the same approach as the plus (+) operator. MATLAB calls `@polynom/minus.m` to compute $p - q$.

```
function r = minus(p,q)
% POLYNOM/MINUS Implement p - q for polynoms.
p = polynom(p);
q = polynom(q);
k = length(q.c) - length(p.c);
r = polynom([zeros(1,k) p.c] - [zeros(1,-k) q.c]);
```

Overloading the * Operator

MATLAB calls the method `@polynom/mtimes.m` to compute the product $p * q$. The letter `m` at the beginning of the function name comes from the fact that it is overloading MATLAB's *matrix* multiplication. Multiplication of two polynomials is simply the convolution of their coefficient vectors.

```
function r = mtimes(p,q)
% POLYNOM/MTIMES Implement p * q for polynoms.
p = polynom(p);
q = polynom(q);
r = polynom(conv(p.c,q.c));
```

Using the Overloaded Operators

Given the polynom object

```
p = polynom([1 0 -2 -5])
```

MATLAB calls these two functions `@polynom/plus.m` and `@polynom/mtimes.m` when you issue the statements

```
q = p+1
r = p*q
```

to produce

```
q =
    x^3 - 2*x - 4
```

```
r =
    x^6 - 4*x^4 - 9*x^3 + 4*x^2 + 18*x + 20
```

Overloading Functions for the Polynom Class

MATLAB already has several functions for working with polynomials represented by coefficient vectors. They should be overloaded to also work with the new polynom object. In many cases, the overloading methods can simply apply the original function to the coefficient field.

Overloading roots for the Polynom Class

The method `@polynom/roots.m` finds the roots of polynom objects.

```
function r = roots(p)
% POLYNOM/ROOTS. ROOTS(p) is a vector containing the roots of p.
r = roots(p.c);
```

The statement

```
roots(p)
```

results in

```
ans =
    2.0946
   -1.0473 + 1.1359i
   -1.0473 - 1.1359i
```

Overloading polyval for the Polynom Class

The function `polyval` evaluates a polynomial at a given set of points. `@polynom/polyval.m` uses nested multiplication, or Horner's method to reduce the number of multiplication operations used to compute the various powers of `x`.

```
function y = polyval(p,x)
% POLYNOM/POLYVAL  POLYVAL(p,x) evaluates p at the points x.
y = 0;
for a = p.c
    y = y.*x + a;
end
```

Overloading plot for the Polynom Class

The overloaded `plot` function uses both `root` and `polyval`. The function selects the domain of the independent variable to be slightly larger than an interval containing all real roots. Then `polyval` is used to evaluate the polynomial at a few hundred points in the domain.

```
function plot(p)
% POLYNOM/PLOT  PLOT(p) plots the polynom p.
r = max(abs(roots(p)));
x = (-1.1:0.01:1.1)*r;
y = polyval(p,x);
plot(x,y);
title(char(p))
grid on
```

Overloading diff for the Polynom Class

The method `@polynom/diff.m` differentiates a polynomial by reducing the degree by 1 and multiplying each coefficient by its original degree.

```
function q = diff(p)
% POLYNOM/DIFF  DIFF(p) is the derivative of the polynom p.
c = p.c;
d = length(c) - 1; % degree
q = polynom(p.c(1:d).*(d:-1:1));
```

Listing Class Methods

The function call

```
methods('class_name')
```

or its command form

```
methods class_name
```

shows all the methods available for a particular class. For the polynom example, the output is

```
methods polynom
```

```
Methods for class polynom:
```

```
char    display    minus    plot    polynom    roots
diff    double    mtimes    plus    polyval    subsref
```

Plotting the two polynom objects `x` and `p` calls most of these methods.

```
x = polynom([1 0]);
p = polynom([1 0 -2 -5]);
plot(diff(p*p + 10*p + 20*x) - 20)
```

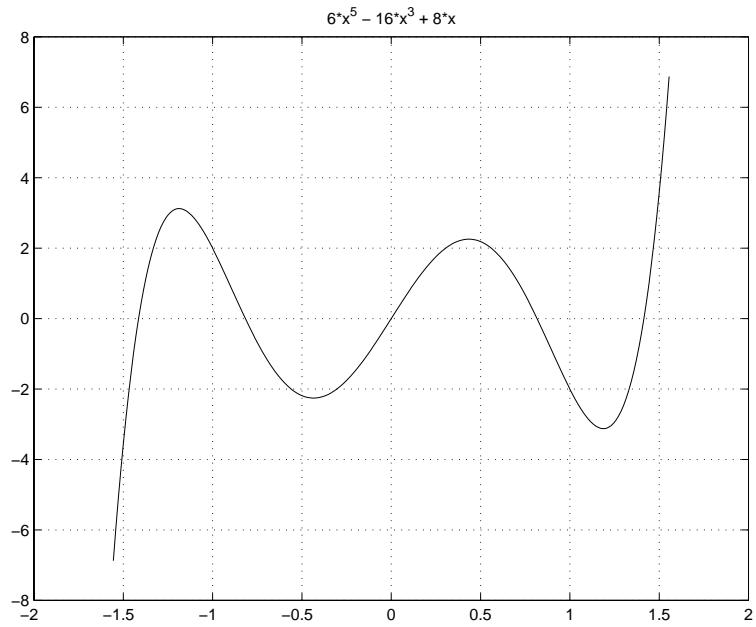

Building on Other Classes

A MATLAB object can *inherit* properties and behavior from another MATLAB object. When one object (the child) inherits from another (the parent), the child object includes all the fields of the parent object and can call the parent's methods. The parent methods can access those fields that a child object inherited from the parent class, but not fields new to the child class.

Inheritance is a key feature of object-oriented programming. It makes it easy to reuse code by allowing child objects to take advantage of code that exists for parent objects. Inheritance enables a child object to behave exactly like a parent object, which facilitates the development of related classes that behave similarly, but are implemented differently.

There are two kinds of inheritance:

- Simple inheritance, in which a child object inherits characteristics from one parent class.
- Multiple inheritance, in which a child object inherits characteristics from more than one parent class.

This section also discusses a related topic, *aggregation*. Aggregation allows one object to contain another object as one of its fields.

Simple Inheritance

A class that inherits attributes from a single parent class, and adds new attributes of its own, uses simple inheritance. Inheritance implies that objects belonging to the child class have the same fields as the parent class, as well as additional fields. Therefore, methods associated with the parent class can operate on objects belonging to the child class. The methods associated with the child class, however, cannot operate on objects belonging to the parent class. You cannot access the parent's fields directly from the child class; you must use access methods defined for the parent.

The constructor function for a class that inherits the behavior of another has two special characteristics:

- It calls the constructor function for the parent class to create the inherited fields.

- The calling syntax for the `class` function is slightly different, reflecting both the child class and the parent class.

The general syntax for establishing a simple inheritance relationship using the `class` function is

```
child_obj = class(child_obj, 'child_class', parent_obj);
```

Simple inheritance can span more than one generation. If a parent class is itself an inherited class, the child object will automatically inherit from the grandparent class.

Visibility of Class Properties and Methods

The parent class does not have knowledge of the child properties or methods. The child class cannot access the parent properties directly, but must use parent access methods (e.g., `get` or `subsref` method) to access the parent properties. From the child class methods, this access is accomplished via the parent field in the child structure. For example, when a constructor creates a child object `c`,

```
c = class(c, 'child_class_name', parent_object);
```

MATLAB automatically creates a field, `c.parent_class_name`, in the object's structure that contains the parent object. You could then have a statement in the child's display method that calls the parent's display method.

```
display(c.parent_class_name)
```

See “Designing the Stock Class” on page 22-45 for examples that use simple inheritance.

Multiple Inheritance

In the multiple inheritance case, a class of objects inherits attributes from more than one parent class. The child object gets fields from all the parent classes, as well as fields of its own.

Multiple inheritance can encompass more than one generation. For example, each of the parent objects could have inherited fields from multiple grandparent objects, and so on. Multiple inheritance is implemented in the constructors by calling `class` with more than three arguments.

```
obj = class(structure, 'class_name', parent1, parent2, ...)
```

You can append as many parent arguments as desired to the class input list.

Multiple parent classes can have associated methods of the same name. In this case, MATLAB calls the method associated with the parent that appears first in the `class` function call in the constructor function. There is no way to access subsequent parent function of this name.

Aggregation

In addition to standard inheritance, MATLAB objects support *containment* or *aggregation*. That is, one object can contain (embed) another object as one of its fields. For example, a rational object might use two polynom objects, one for the numerator and one for the denominator.

You can call a method for the contained object only from within a method for the outer object. When determining which version of a function to call, MATLAB considers only the outermost containing class of the objects passed as arguments; the classes of any contained objects are ignored.

See “Example - The Portfolio Container” on page 22-54 for an example of aggregation.

Example - Assets and Asset Subclasses

As an example of simple inheritance, consider a general asset class that can be used to represent any item that has monetary value. Some examples of an asset are: stocks, bonds, savings accounts, and any other piece of property. In designing this collection of classes, the asset class holds the data that is common to all of the specialized asset subclasses. The individual asset subclasses, such as the stock class, inherit the asset properties and contribute additional properties. The subclasses are “kinds of” assets.

Inheritance Model for the Asset Class

An example of a simple inheritance relationship using an asset parent class is shown in this diagram.

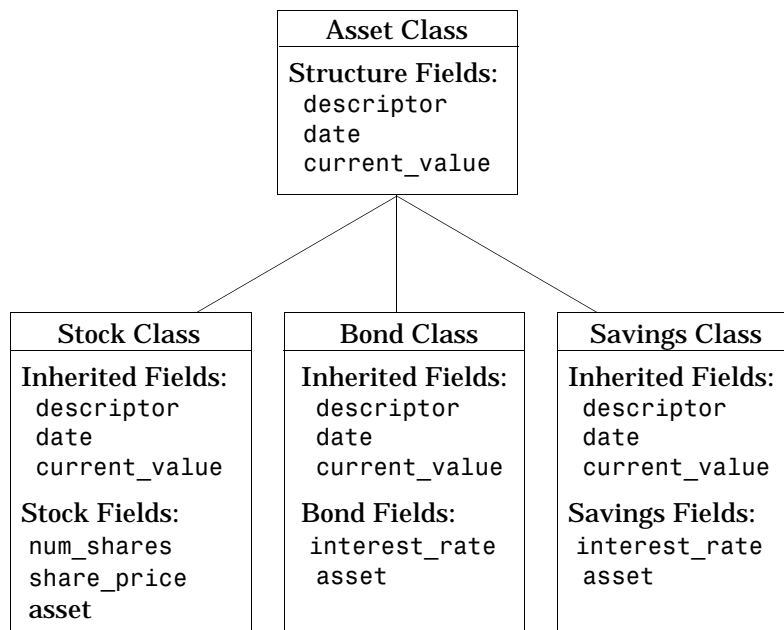

As shown in the diagram, the stock, bond, and savings classes inherit structure fields from the asset class. In this example, the asset class is used to provide storage for data common to all subclasses and to share asset methods with these subclasses. This example shows how to implement the

asset and stock classes. The bond and savings classes can be implemented in a way that is very similar to the stock class, as would other types of asset subclasses.

Asset Class Design

The asset class provides storage and access for information common to all asset children. It is not intended to be instantiated directly, so it does not require an extensive set of methods. To serve its purpose, the class needs to contain the following methods:

- Constructor
- get and set
- subsref and subsasgn
- display

Other Asset Methods

The asset class provides inherited data storage for its child classes, but is not instanced directly. The set, get, and display methods provide access to the stored data. It is not necessary to implement the full complement of methods for asset objects (such as converters, end, and subsindex) since only the child classes access the data.

The Asset Constructor Method

The asset class is based on a structure array with four fields:

- descriptor – Identifier of the particular asset (e.g., stock name, savings account number, etc.)
- date – The date the object was created (calculated by the date command)
- type – The type of asset (e.g., savings, bond, stock)
- current_value – The current value of the asset (calculated from subclass data)

This information is common to asset child objects (stock, bond, and savings), so it is handled from the parent object to avoid having to define the same fields in each child class. This is particularly helpful as the number of child classes increases.

```
function a = asset(varargin)
% ASSET Constructor function for asset object
% a = asset(descriptor, current_value)
switch nargin
case 0
% if no input arguments, create a default object
    a.descriptor = 'none';
    a.date = date;
    a.type = 'none';
    a.current_value = 0;
    a = class(a,'asset');
case 1
% if single argument of class asset, return it
    if (isa(varargin{1},'asset'))
        a = varargin{1};
    else
        error('Wrong argument type')
    end
case 2
% create object using specified values
    a.descriptor = varargin{1};
    a.date = date;
    a.type = varargin{2};
    a.current_value = varargin{3};
    a = class(a,'asset');
otherwise
    error('Wrong number of input arguments')
end
```

The function uses a switch statement to accommodate three possible scenarios:

- Called with no arguments, the constructor returns a default asset object.
- Called with one argument that is an asset object, the object is simply returned.
- Called with two arguments (subclass descriptor, and current value), the constructor returns a new asset object.

The asset constructor method is not intended to be called directly; it is called from the child constructors since its purpose is to provide storage for common data.

The Asset get Method

The asset class needs methods to access the data contained in asset objects. The following function implements a get method for the class. It uses capitalized property names rather than literal field names to provide an interface similar to other MATLAB objects.

```
function val = get(a,prop_name)
% GET Get asset properties from the specified object
% and return the value
switch prop_name
case 'Descriptor'
    val = a.descriptor;
case 'Date'
    val = a.date;
case 'CurrentValue'
    val = a.current_value;
otherwise
    error([prop_name,' Is not a valid asset property'])
end
```

This function accepts an object and a property name and uses a switch statement to determine which field to access. This method is called by the subclass get methods when accessing the data in the inherited properties. See “The Stock get Method” on page 22-48 for an example.

The Asset set Method

The asset class set method is called by subclass set methods. This method accepts an asset object and variable length argument list of property name/property value pairs and returns the modified object.

```
function a = set(a,varargin)
% SET Set asset properties and return the updated object
property_argin = varargin;
while length(property_argin) >= 2,
    prop = property_argin{1};
    val = property_argin{2};
```

```
property_argin = property_argin(3:end);
switch prop
case 'Descriptor'
    a.descriptor = val;
case 'Date'
    a.date = val;
case 'CurrentValue'
    a.current_value = val;
otherwise
    error('Asset properties: Descriptor, Date, CurrentValue')
end
end
```

Subclass set methods call the asset set method and require the capability to return the modified object since MATLAB does not support passing arguments by reference. See “The Stock set Method” on page 22-48 for an example.

The Asset subsref Method

The `subsref` method provides access to the data contained in an asset object using one-based numeric indexing and structure field name indexing. The outer switch statement determines if the index is a numeric or field name syntax. The inner switch statements map the index to the appropriate value.

MATLAB calls `subsref` whenever you make a subscripted reference to an object (e.g., `A(i)`, `A{i}`, or `A.fieldname`).

```
function b = subsref(a,index)
%SUBSREF Define field name indexing for asset objects
switch index.type
case '('
    switch index.subs{:}
    case 1
        b = a.descriptor;
    case 2
        b = a.date;
    case 3
        b = a.current_value;
    otherwise
        error('Index out of range')
    end
end
```



```

case '.'
    switch index.subs
    case 'descriptor'
        b = a.descriptor;
    case 'date'
        b = a.date;
    case 'current_value'
        b = a.current_value;
    otherwise
        error('Invalid field name')
    end
end
case '{} '
    error('Cell array indexing not supported by asset objects')
end
end

```

See the “The Stock subsref Method” on page 22-49 for an example of how the child subsref method calls the parent subsref method.

The Asset subsasgn Method

The subsasgn method is the assignment equivalent of the subsref method. This version enables you to change the data contained in an object using one-based numeric indexing and structure field name indexing. The outer switch statement determines if the index is a numeric or field name syntax. The inner switch statements map the index value to the appropriate value in the stock structure.

MATLAB calls subsasgn whenever you execute an assignment statement (e.g., $A(i) = val$, $A\{i\} = val$, or $A.fieldname = val$).

```

function a = subsasgn(a,index,val)
% SUBSASGN Define index assignment for asset objects
switch index.type
case '()'
    switch index.subs{:}
    case 1
        a.descriptor = val;
    case 2
        a.date = val;
    case 3
        a.current_value = val;

```

```
        otherwise
            error('Index out of range')
        end
    case '.'
        switch index.subs
            case 'descriptor'
                a.descriptor = val;
            case 'date'
                a.date = val;
            case 'current_value'
                a.current_value = val;
            otherwise
                error('Invalid field name')
            end
        end
    end
end
```

The `subsasgn` method enables you to assign values to the asset object data structure using two techniques. For example, suppose you have a child stock object `s`.

```
s = stock('XYZ',100,25);
```

Within stock class methods, you could change the `descriptor` field with either of the following statements

```
s.asset(1) = 'ABC';
```

or

```
s.asset.descriptor = 'ABC';
```

See the “The Stock `subsasgn` Method” on page 22-51 for an example of how the child `subsasgn` method calls the parent `subsasgn` method.

The Asset display Method

The `asset display` method is designed to be called from child-class `display` methods. Its purpose is to display the data it stores for the child object. The method simply formats the data for display in a way that is consistent with the formatting of the child’s `display` method.

```
function display(a)
% DISPLAY(a) Display an asset object
```

```

stg = sprintf(...
    'Descriptor: %s\nDate: %s\nType: %s\nCurrent Value:%9.2f',...
    a.descriptor,a.date,a.current_value);
disp(stg)

```

The stock class display method can now call this method to display the data stored in the parent class. This approach isolates the stock display method from changes to the asset class. See “The Stock display Method” on page 22-52 for an example of how this method is called.

The Asset fieldcount Method

The asset `fieldcount` method returns the number of fields in the asset object data structure. `fieldcount` enables asset child methods to determine the number of fields in the asset object during execution, rather than requiring the child methods to have knowledge of the asset class. This allows you to make changes to the number of fields in the asset class data structure without having to change child-class methods.

```

function num_fields = fieldcount(asset_obj)
% Determines the number of fields in an asset object
% Used by asset child class methods
num_fields = length(fieldnames(asset_obj));

```

The `struct` function converts an object to its equivalent data structure, enabling access to the structure’s contents.

Designing the Stock Class

A stock object is designed to represent one particular asset in a person’s investment portfolio. This object contains two properties of its own and inherits three properties from its parent asset object.

Stock properties:

- `NumberShares` – The number of shares for the particular stock object.
- `SharePrice` – The value of each share.

Asset properties:

- `Descriptor` – The identifier of the particular asset (e.g., stock name, savings account number, etc.).

- Date – The date the object was created (calculated by the date command).
- CurrentValue – The current value of the asset.

Note that the property names are not actually the same as the field names of the structure array used internally by stock and asset objects. The property name interface is controlled by the stock and asset set and get methods and is designed to resemble the interface of other MATLAB object properties.

The asset field in the stock object structure contains the parent asset object and is used to access the inherited fields in the parent structure.

Stock Class Methods

The stock class implements the following methods:

- Constructor
- get and set
- subsref and subsasgn
- display

The Stock Constructor Method

The stock constructor creates a stock object from three input arguments:

- The stock name
- The number of shares
- The share price

The constructor must create an asset object from within the stock constructor to be able to specify it as a parent to the stock object. The stock constructor must, therefore, call the asset constructor. The class function, which is called to create the stock object, defines the asset object as the parent.

Keep in mind that the asset object is created in the temporary workspace of the stock constructor function and is stored as a field (.asset) in the stock structure. The stock object inherits the asset fields, but the asset object is not returned to the base workspace.

```
function s = stock(varargin)
% STOCK Stock class constructor.
% s = stock(descriptor, num_shares, share_price)
switch nargin
```

```

case 0
% if no input arguments, create a default object
    s.num_shares = 0;
    s.share_price = 0;
    a = asset('none',0);
    s = class(s, 'stock',a);
case 1
% if single argument of class stock, return it
    if (isa(varargin{1},'stock'))
        s = varargin{1};
    else
        error('Input argument is not a stock object')
    end
case 3
% create object using specified values
    s.num_shares = varargin{2};
    s.share_price = varargin{3};
    a = asset(varargin{1},'stock',varargin{2} * varargin{3});
    s = class(s,'stock',a);
otherwise
    error('Wrong number of input arguments')
end

```

Constructor Calling Syntax

The stock constructor method can be called in one of three ways:

- **No Input Argument** – If called with no arguments, the constructor returns a default object with empty fields.
- **Input Argument is a Stock Object** – If called with a single input argument that is a stock object, the constructor returns the input argument. A single argument that is not a stock object generates an error.
- **Three Input Arguments** – If there are three input arguments, the constructor uses them to define the stock object.

Otherwise, if none of the above three conditions are met, return an error.

For example, this statement creates a stock object to record the ownership of 100 shares of XYZ corporation stocks with a price per share of 25 dollars.

```
XYZ_stock = stock('XYZ',100,25);
```

The Stock get Method

The get method provides a way to access the data in the stock object using a “property name” style interface, similar to Handle Graphics. While in this example the property names are similar to the structure field name, they can be quite different. You could also choose to exclude certain fields from access via the get method or return the data from the same field for a variety of property names, if such behavior suits your design.

```
function val = get(s,prop_name)
% GET Get stock property from the specified object
% and return the value. Property names are: NumberShares
% SharePrice, Descriptor, Date, CurrentValue
switch prop_name
case 'NumberShares'
    val = s.num_shares;
case 'SharePrice'
    val = s.share_price;
case 'Descriptor'
    val = get(s.asset,'Descriptor'); % call asset get method
case 'Date'
    val = get(s.asset,'Date');
case 'CurrentValue'
    val = get(s.asset,'CurrentValue');
otherwise
    error([prop_name , 'Is not a valid stock property'])
end
```

Note that the asset object is accessed via the stock object’s asset field (`s.asset`). MATLAB automatically creates this field when the `class` function is called with the parent argument.

The Stock set Method

The set method provides a “property name” interface like the get method. It is designed to update the number of shares, the share value, and the descriptor. The current value and the date are automatically updated.

```
function s = set(s,varargin)
% SET Set stock properties to the specified values
% and return the updated object
property_argin = varargin;
```

```

while length(property_argin) >= 2,
    prop = property_argin{1};
    val = property_argin{2};
    property_argin = property_argin(3:end);
    switch prop
    case 'NumberShares'
        s.num_shares = val;
    case 'SharePrice'
        s.share_price = val;
    case 'Descriptor'
        s.asset = set(s.asset, 'Descriptor', val);
    otherwise
        error('Invalid property')
    end
end
s.asset = set(s.asset, 'CurrentValue', ...
             s.num_shares * s.share_price, 'Date', date);

```

Note that this function creates and returns a new stock object with the new values, which you then copy over the old value. For example, given the stock object,

```
s = stock('XYZ', 100, 25);
```

the following set command updates the share price.

```
s = set(s, 'SharePrice', 36);
```

It is necessary to copy over the original stock object (i.e., assign the output to `s`) because MATLAB does not support passing arguments by reference. Hence the set method actually operates on a copy of the object.

The Stock subsref Method

The `subsref` method defines subscripted indexing for the stock class. In this example, `subsref` is implemented to enable numeric and structure field name indexing of stock objects.

```

function b = subsref(s, index)
% SUBSREF Define field name indexing for stock objects
fc = fieldcount(s.asset);
switch index.type

```

```
case '(')
    if (index.subs{:} <= fc)
        b = subsref(s.asset,index);
    else
        switch index.subs{:} - fc
            case 1
                b = s.num_shares;
            case 2
                b = s.share_price;
            otherwise
                error(['Index must be in the range 1 to ',num2str(fc + 2)])
            end
        end
    end
case '.'
    switch index.subs
        case 'num_shares'
            b = s.num_shares;
        case 'share_price'
            b = s.share_price;
        otherwise
            b = subsref(s.asset,index);
    end
end
```

The outer switch statement determines if the index is a numeric or field name syntax.

The `fieldcount` asset method determines how many fields there are in the asset structure, and the `if` statement calls the asset `subsref` method for indices 1 to `fieldcount`. See “The Asset `fieldcount` Method” on page 22-45 and “The Asset `subsref` Method” on page 22-42 for a description of these methods.

Numeric indices greater than the number returned by `fieldcount` are handled by the inner switch statement, which maps the index value to the appropriate field in the stock structure.

Field-name indexing assumes field names other than `num_shares` and `share_price` are asset fields, which eliminates the need for knowledge of asset fields by child methods. The asset `subsref` method performs field-name error checking.

See the `subsref` help entry for general information on implementing this method.

The Stock `subsasgn` Method

The `subsasgn` method enables you to change the data contained in a stock object using numeric indexing and structure field name indexing. MATLAB calls `subsasgn` whenever you execute an assignment statement (e.g., `A(i) = val`, `A{i} = val`, or `A.fieldname = val`).

```
function s = subsasgn(s,index,val)
% SUBSASGN Define index assignment for stock objects
fc = fieldcount(s.asset);
switch index.type
case '()'
    if (index.subs{:} <= fc)
        s.asset = subsasgn(s.asset,index,val);
    else
        switch index.subs{:}-fc
        case 1
            s.num_shares = val;
        case 2
            s.share_price = val;
        otherwise
            error(['Index must be in the range 1 to ',num2str(fc + 2)])
        end
    end
case '.'
    switch index.subs
    case 'num_shares'
        s.num_shares = val;
    case 'share_price'
        s.share_price = val;
    otherwise
        s.asset = subsasgn(s.asset,index,val);
    end
end
end
```

The outer switch statement determines if the index is a numeric or field name syntax.

The `fieldcount` asset method determines how many fields there are in the asset structure and the `if` statement calls the `asset subsasgn` method for indices 1 to `fieldcount`. See “The Asset `fieldcount` Method” on page 22-45 and “The Asset `subsasgn` Method” on page 22-43 for a description of these methods.

Numeric indices greater than the number returned by `fieldcount` are handled by the inner `switch` statement, which maps the index value to the appropriate field in the stock structure.

Field-name indexing assumes field names other than `num_shares` and `share_price` are asset fields, which eliminates the need for knowledge of asset fields by child methods. The `asset subsasgn` method performs field-name error checking.

The `subsasgn` method enables you to assign values to stock object data structure using two techniques. For example, suppose you have a stock object

```
s = stock('XYZ',100,25)
```

You could change the descriptor field with either of the following statements

```
s(1) = 'ABC';
```

or

```
s.descriptor = 'ABC';
```

See the `subsasgn` help entry for general information on assignment statements in MATLAB.

The Stock display Method

When you issue the statement (without terminating with a semicolon)

```
XYZStock = stock('XYZ',100,25)
```

MATLAB looks for a method in the `@stock` directory called `display`. The `display` method for the stock class produces this output.

```
Descriptor: XYZ  
Date: 17-Nov-1998  
Type: stock  
Current Value: 2500.00  
Number of shares: 100  
Share price: 25.00
```

Here is the stock display method.

```
function display(s)
% DISPLAY(s) Display a stock object
display(s.asset)
stg = sprintf('Number of shares: %g\nShare price: %3.2f\n',...
    s.num_shares,s.share_price);
disp(stg)
```

First, the parent asset object is passed to the asset display method to display its fields (MATLAB calls the asset display method because the input argument is an asset object). The stock object's fields are displayed in a similar way using a formatted text string.

Note that if you did not implement a stock class display method, MATLAB would call the asset display method. This would work, but would display only the descriptor, date, type, and current value.

Example - The Portfolio Container

Aggregation is the containment of one class by another class. The basic relationship is: each contained class “is a part of” the container class.

For example, consider a financial portfolio class as a container for a set of assets (stocks, bonds, savings, etc.). Once the individual assets are grouped, they can be analyzed, and useful information can be returned. The contained objects are not accessible directly, but only via the portfolio class methods.

See “Example - Assets and Asset Subclasses” on page 22-38 for information about the assets collected by this portfolio class.

Designing the Portfolio Class

The portfolio class is designed to contain the various assets owned by a given individual and provide information about the status of his or her investment portfolio. This example implements a somewhat over-simplified portfolio class that:

- Contains an individual’s assets
- Displays information about the portfolio contents
- Displays a 3-D pie chart showing the relative mix of asset types in the portfolio

Required Portfolio Methods

The portfolio class implements only three methods:

- `portfolio` – The portfolio constructor.
- `display` – Displays information about the portfolio contents.
- `pie3` – Overloaded version of `pie3` function designed to take a single portfolio object as an argument.

Since a portfolio object contains other objects, the portfolio class methods can use the methods of the contained objects. For example, the portfolio `display` method calls the stock class `display` method, and so on.

The Portfolio Constructor Method

The portfolio constructor method takes as input arguments a client's name and a variable length list of asset subclass objects (stock, bond, and savings objects in this example). The portfolio object uses a structure array with the following fields:

- name – The client's name.
- ind_assets – The array of asset subclass objects (stock, bond, savings).
- total_value – The total value of all assets. The constructor calculates this value from the objects passed in as arguments.
- account_number – The account number. This field is assigned a value only when you save a portfolio object (see “Saving and Loading Objects” on page 22-60).

```
function p = portfolio(name,varargin)
% PORTFOLIO Create a portfolio object containing the
% client's name and a list of assets
switch nargin
case 0
    % if no input arguments, create a default object
    p.name = 'none';
    p.total_value = 0;
    p.ind_assets = {};
    p.account_number = '';
    p = class(p,'portfolio');
case 1
    % if single argument of class portfolio, return it
    if isa(name,'portfolio')
        p = name;
    else
        disp([inputname(1) ' is not a portfolio object'])
        return
    end
otherwise
    % create object using specified arguments
    p.name = name;
    p.total_value = 0;
    for k = 1:length(varargin)
```

```
        p.ind_assets(k) = {varargin{k}};
        asset_value = get(p.ind_assets{k}, 'CurrentValue');
        p.total_value = p.total_value + asset_value;
    end
    p.account_number = '';
    p = class(p, 'portfolio');
end
```

Constructor Calling Syntax

The portfolio constructor method can be called in one of three different ways:

- No input arguments – If called with no arguments, it returns an object with empty fields.
- Input argument is an object – If the input argument is already a portfolio object, MATLAB returns the input argument. The `isa` function checks for this case.
- More than two input arguments – If there are more than two input arguments, the constructor assumes the first is the client's name and the rest are asset subclass objects. A more thorough implementation would perform more careful input argument checking, for example, using the `isa` function to determine if the arguments are the correct class of objects.

The Portfolio display Method

The portfolio `display` method lists the contents of each contained object by calling the object's `display` method. It then lists the client name and total asset value.

```
function display(p)
% DISPLAY Display a portfolio object
for k = 1:length(p.ind_assets)
    display(p.ind_assets{k})
end
stg = sprintf('\nAssets for Client: %s\nTotal Value: %9.2f\n',...
p.name,p.total_value);
disp(stg)
```

The Portfolio pie3 Method

The portfolio class overloads the MATLAB pie3 function to accept a portfolio object and display a 3-D pie chart illustrating the relative asset mix of the client's portfolio. MATLAB calls the @portfolio/pie3.m version of pie3 whenever the input argument is a single portfolio object.

```
function pie3(p)
% PIE3 Create a 3-D pie chart of a portfolio
stock_amt = 0; bond_amt = 0; savings_amt = 0;
for k = 1:length(p.ind_assets)
    if isa(p.ind_assets{k},'stock')
        stock_amt = stock_amt + ...
            get(p.ind_assets{k},'CurrentValue');
    elseif isa(p.ind_assets{k},'bond')
        bond_amt = bond_amt + ...
            get(p.ind_assets{k},'CurrentValue');
    elseif isa(p.ind_assets{k},'savings')
        savings_amt = savings_amt + ...
            get(p.ind_assets{k},'CurrentValue');
    end
end
i = 1;
if stock_amt ~= 0
    label(i) = {'Stocks'};
    pie_vector(i) = stock_amt;
    i = i + 1;
end
if bond_amt ~= 0
    label(i) = {'Bonds'};
    pie_vector(i) = bond_amt;
    i = i + 1;
end
if savings_amt ~= 0
    label(i) = {'Savings'};
    pie_vector(i) = savings_amt;
end
pie3(pie_vector,label)
set(gcf,'Renderer','zbuffer')
set(findobj(gca,'Type','Text'),'FontSize',14)
cm = gray(64);
```

```
colormap(cm(48:end,:))
stg(1) = {'Portfolio Composition for ',p.name}};
stg(2) = {'Total Value of Assets: $',num2str(p.total_value)}};
title(stg,'FontSize',12)
```

There are three parts in the overloaded `pie3` method.

- The first uses the asset subclass get methods to access the `CurrentValue` property of each contained object. The total value of each class is summed.
- The second part creates the pie chart labels and builds a vector of graph data, depending on which objects are present.
- The third part calls the MATLAB `pie3` function, makes some font and colormap adjustments, and adds a title.

Creating a Portfolio

Suppose you have implemented a collection of asset subclasses in a manner similar to the stock class. You can then use a portfolio object to present the individual's financial portfolio. For example, given the following assets

```
XYZStock = stock('XYZ',200,12);
SaveAccount = savings('Acc # 1234',2000,3.2);
Bonds = bond('U.S. Treasury',1600,12);
```

Create a portfolio object.

```
p = portfolio('Gilbert Bates',XYZStock,SaveAccount,Bonds)
```

The portfolio `display` method summarizes the portfolio contents (because this statement is not terminated by a semicolon).

```
Descriptor: XYZ
Date: 24-Nov-1998
Current Value: 2400.00
Type: stock
Number of shares: 200
Share price: 12.00

Descriptor: Acc # 1234
Date: 24-Nov-1998
Current Value: 2000.00
Type: savings
Interest Rate: 3.2%
```

Descriptor: U.S. Treasury
Date: 24-Nov-1998
Current Value: 1600.00
Type: bond
Interest Rate: 12%

Assets for Client: Gilbert Bates
Total Value: 6000.00

The portfolio `pie3` method displays the relative mix of assets using a pie chart.

`pie3(p)`

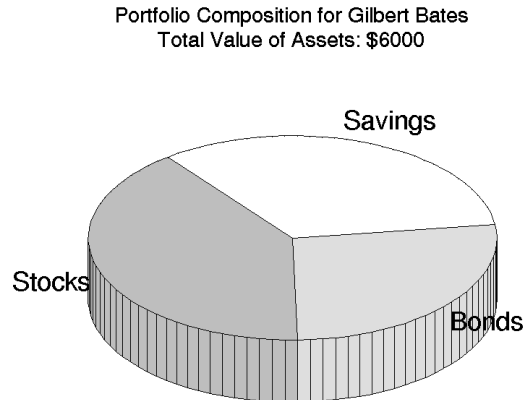

Saving and Loading Objects

You can use the MATLAB `save` and `load` commands to save and retrieve user-defined objects to and from `.mat` files, just like any other variables.

When you load objects, MATLAB calls the object's class constructor to register the object in the workspace. The constructor function for the object class you are loading must be able to be called with no input arguments and return a default object. See “Guidelines for Writing a Constructor” on page 22-10 for more information.

Modifying Objects During Save or Load

When you issue a `save` or `load` command on objects, MATLAB looks for class methods called `saveobj` and `loadobj` in the class directory. You can overload these methods to modify the object before the save or load operation. For example, you could define a `saveobj` method that saves related data along with the object or you could write a `loadobj` method that updates objects to a newer version when this type of object is loaded into the MATLAB workspace.

Example - Defining saveobj and loadobj for Portfolio

In the section “Example - The Portfolio Container” on page 22-54, portfolio objects are used to collect information about a client’s investment portfolio. Now suppose you decide to add an account number to each portfolio object that is saved. You can define a portfolio saveobj method to carry out this task automatically during the save operation.

Suppose further that you have already saved a number of portfolio objects without the account number. You want to update these objects during the load operation so that they are still valid portfolio objects. You can do this by defining a loadobj method for the portfolio class.

Summary of Code Changes

To implement the account number scenario, you need to add or change the following functions:

- portfolio – The portfolio constructor method needs to be modified to create a new field, account_number, which is initialized to the empty string when an object is created.
- saveobj – A new portfolio method designed to add an account number to a portfolio object during the save operation, only if the object does not already have one.
- loadobj – A new portfolio method designed to update older versions of portfolio objects that were saved before the account number structure field was added.
- subsref – A new portfolio method that enables subscripted reference to portfolio objects outside of a portfolio method.
- getAccountNumber – a MATLAB function that returns an account number that consists of the first three letters of the client’s name.

New Portfolio Class Behavior

With the additions and changes made in this example, the portfolio class now:

- Includes a field for an account number
- Adds the account number when a portfolio object is saved for the first time

- Automatically updates the older version of portfolio objects when you load them into the MATLAB workspace

The saveobj Method

MATLAB looks for the portfolio `saveobj` method whenever the `save` command is passed a portfolio object. If `@portfolio/saveobj` exists, MATLAB passes the portfolio object to `saveobj`, which must then return the modified object as an output argument. The following implementation of `saveobj` determines if the object has already been assigned an account number from a previous save operation. If not, `saveobj` calls `getAccountNumber` to obtain the number and assigns it to the `account_number` field.

```
function b = saveobj(a)
if isempty(a.account_number)
    a.account_number = getAccountNumber(a);
end
b = a;
```

The loadobj Method

MATLAB looks for the portfolio `loadobj` method whenever the `load` command detects portfolio objects in the `.mat` file being loaded. If `loadobj` exists, MATLAB passes the portfolio object to `loadobj`, which must then return the modified object as an output argument. The output argument is then loaded into the workspace.

If the input object does not match the current definition as specified by the constructor function, then MATLAB converts it to a structure containing the same fields and the object's structure with all the values intact (that is, you now have a structure, not an object).

The following implementation of `loadobj` first uses `isa` to determine whether the input argument is a portfolio object or a structure. If the input is an object, it is simply returned since no modifications are necessary. If the input argument has been converted to a structure by MATLAB, then the new `account_number` field is added to the structure and is used to create an updated portfolio object.

```
function b = loadobj(a)
% loadobj for portfolio class
if isa(a,'portfolio')
```

```

    b = a;
else % a is an old version
    a.account_number = getAccountNumber(a);
    b = class(a,'portfolio');
end

```

Changing the Portfolio Constructor

The portfolio structure array needs an additional field to accommodate the account number. To create this field, add the line

```
p.account_number = '';
```

to @portfolio/portfolio.m in both the zero argument and variable argument sections.

The getAccountNumber Function

In this example, getAccountNumber is a MATLAB function that returns an account number composed of the first three letters of the client name prepended to a series of digits. To illustrate implementation techniques, getAccountNumber is not a portfolio method so it cannot access the portfolio object data directly. Therefore, it is necessary to define a portfolio subsref method that enables access to the name field in a portfolio object's structure.

For this example, getAccountNumber simply generates a random number, which is formatted and concatenated with elements 1 to 3 from the portfolio name field.

```

function n = getAccountNumber(p)
% provides a account number for object p
n = [upper(p.name(1:3)) strcat(num2str(round(rand(1,7)*10))')'];

```

Note that the portfolio object is indexed by field name, and then by numerical subscript to extract the first three letters. The subsref method must be written to support this form of subscripted reference.

The Portfolio subsref Method

When MATLAB encounters a subscripted reference, such as that made in the `getAccountNumber` function

```
p.name(1:3)
```

MATLAB calls the `portfolio subsref` method to interpret the reference. If you do not define a `subsref` method, the above statement is undefined for portfolio objects (recall that here `p` is an object, not just a structure).

The `portfolio subsref` method must support field-name and numeric indexing for the `getAccountNumber` function to access the portfolio name field.

```
function b = subsref(p,index)
% SUBSREF Define field name indexing for portfolio objects
switch index(1).type
case '.'
    switch index(1).subs
    case 'name'
        if length(index)== 1
            b = p.name;
        else
            switch index(2).type
            case '()'
                b = p.name(index(2).subs{:});
            end
        end
    end
end
end
```

Note that the `portfolio` implementation of `subsref` is designed to provide access to specific elements of the `name` field; it is not a general implementation that provides access to all structure data, such as the `stock` class implementation of `subsref`.

See the `subsref` help entry for more information about indexing and objects.

Object Precedence

Object precedence is a means to resolve the question of which of possibly many versions of an operator or function to call in a given situation. Object precedence enables you to control the behavior of expressions containing different classes of objects. For example, consider the expression

$$\text{objectA} + \text{objectB}$$

Ordinarily, MATLAB assumes that the objects have equal precedence and calls the method associated with the leftmost object. However, there are two exceptions:

- User-defined classes have precedence over MATLAB built-in classes.
- User-defined classes can specify their relative precedence with respect to other user-defined classes using the `inferioorto` and `superiorto` functions.

For example, in the section “Example - A Polynomial Class” on page 22-24 the `polynom` class defines a `plus` method that enables addition of polynom objects. Given the polynom object `p`

```
p = polynom([1 0 -2 -5])
```

```
p =
```

$$x^3 - 2x - 5$$

The expression,

```
1 + p
```

```
ans =
```

$$x^3 - 2x - 4$$

calls the polynom `plus` method (which converts the double, 1, to a polynom object, and then adds it to `p`). The user-defined polynom class has precedence over the MATLAB double class.

Specifying Precedence of User-Defined Classes

You can specify the relative precedence of user-defined classes by calling the `inferiorto` or `superiorto` function in the class constructor.

The `inferiorto` function places a class below other classes in the precedence hierarchy. The calling syntax for the `inferiorto` function is

```
inferiorto('class1','class2',...)
```

You can specify multiple classes in the argument list, placing the class below many other classes in the hierarchy.

Similarly, the `superiorto` function places a class above other classes in the precedence hierarchy. The calling syntax for the `superiorto` function is

```
superiorto('class1','class2',...)
```

Location in the Hierarchy

If *objectA* is above *objectB* in the precedence hierarchy, then the expression

```
objectA + objectB
```

calls `@classA/plus.m`. Conversely, if *objectB* is above *objectA* in the precedence hierarchy, then MATLAB calls `@classB/plus.m`.

See “How MATLAB Determines Which Method to Call” on page 22-67 for related information.

How MATLAB Determines Which Method to Call

In MATLAB, functions exist in directories in the computer's file system. A directory may contain many functions (M-files). Function names are unique only within a single directory (e.g., more than one directory may contain a function called `pie3`). When you type a function name on the command line, MATLAB must search all the directories it is aware of to determine which function to call. This list of directories is called the *MATLAB path*.

When looking for a function, MATLAB searches the directories in the order they are listed in the path, and calls the first function whose name matches the name of the specified function.

If you write an M-file called `pie3.m` and put it in a directory that is searched before the `specgraph` directory that contains MATLAB's `pie3` function, then MATLAB uses your `pie3` function instead (note that this is not true for built-in functions like `plot`, which are always found first).

Object-oriented programming allows you to have many methods (MATLAB functions located in class directories) with the same name and enables MATLAB to determine which method to use based on the type or class of the variables passed to the function. For example, if `p` is a portfolio object, then

```
pie3(p)
```

calls `@portfolio/pie3.m` because the argument is a portfolio object.

Selecting a Method

When you call a method for which there are multiple versions with the same name, MATLAB determines the method to call by:

- Looking at the classes of the objects in the argument list to determine which argument has the highest object precedence; the class of this object controls the method selection and is called the *dispatch type*.
- Applying the *function precedence order* to determine which of possibly several implementations of a method to call. This order is determined by the location and type of function.

Determining the Dispatch Type

MATLAB first determines which argument controls the method selection. The class type of this argument then determines the class in which MATLAB searches for the method. The controlling argument is either:

- The argument with the highest precedence, or
- The leftmost of arguments having equal precedence

User-defined objects take precedence over MATLAB's built-in classes such as `double` or `char`. You can set the relative precedence of user-defined objects with the `inferiorto` and `superiorto` functions, as described in "Object Precedence" on page 22-65.

MATLAB searches for functions by name. When you call a function, MATLAB knows the name, number of arguments, and the type of each argument. MATLAB uses the dispatch type to choose among multiple functions of the same name, but does not consider the number of arguments.

Function Precedence Order

The function precedence order determines the precedence of one function over another based on the type of function and its location on the MATLAB path. From the perspective of method selection, MATLAB contains two types of functions: those built into MATLAB, and those written as M-files. MATLAB treats these types differently when determining the function precedence order.

MATLAB selects the correct function for a given context by applying the following function precedence rules, in the order given.

For built-in functions:

1 Overloaded Methods

If there is a method in the class directory of the dispatching argument that has the same name as a MATLAB built-in function, then this method is called instead of the built-in function.

2 Nonoverloaded MATLAB Functions

If there is no overloaded method, then the MATLAB built-in function is called.

MATLAB built-in functions take precedence over both subfunctions and private functions. Therefore, subfunctions or private functions with the same name as MATLAB built-in functions can never be called.

For nonbuilt-in functions:

1 Subfunctions

Subfunctions take precedence over all other M-file functions and overloaded methods that are on the path and have the same name. Even if the function is called with an argument of type matching that of an overloaded method, MATLAB uses the subfunction and ignores the overloaded method.

2 Private Functions

Private functions are called if there is no subfunction of the same name within the current scope. As with subfunctions, even if the function is called with an argument of type matching that of an overloaded method, MATLAB uses the private function and ignores the overloaded method.

3 Class Constructor Functions

Constructor functions (functions having names that are the same as the @ directory, for example @polynom/polynom.m) take precedence over other MATLAB functions. Therefore, if you create an M-file called polynom.m and put it on your path before the constructor @polynom/polynom.m version, MATLAB will always call the constructor version.

4 Overloaded Methods

MATLAB calls an overloaded method if it is not masked by a subfunction or private function.

5 Current Directory

A function in the current working directory is selected before one elsewhere on the path.

6 Elsewhere On Path

Finally, a function anywhere else on the path is selected.

Selecting Methods from Multiple Directories

There may be a number of directories on the path that contain methods with the same name. MATLAB stops searching when it finds the first implementation of the method on the path, regardless of the implementation type (MEX-file, P-code, M-file).

Selecting Methods from Multiple Implementation Types

There are four file precedence types. MATLAB uses file precedence to select between identically named functions in the same directory. The order of precedence for file types is:

- 1 MEX-files
- 2 MDL-file (Simulink model)
- 3 P-code
- 4 M-file

For example, if MATLAB finds a P-code and an M-file version of a method in a class directory, then the P-code version is used. It is, therefore, important to regenerate the P-code version whenever you edit the M-file.

Querying Which Method MATLAB Will Call

You can determine which method MATLAB will call using the `which` command. For example,

```
which pie3
your_matlab_path/toolbox/matlab/specgraph/pie3.m
```

However, if `p` is a portfolio object,

```
which pie3(p)
dir_on_your_path/@portfolio/pie3.m % portfolio method
```

The `which` command determines which version of `pie3` MATLAB will call if you passed a portfolio object as the input argument. To see a list of all versions of a particular function that are on your MATLAB path, use the `-all` option. See the `which` reference page for more information on this command.

External Interfaces and the MATLAB API

Finding the Documentation in Online Help A-2

Reference Documentation A-4

Finding the Documentation in Online Help

MATLAB provides interface capabilities that allow you to communicate between MATLAB and the following programs and devices:

- External C and Fortran programs
- Object-oriented technologies like Java and ActiveX
- Hardware devices on your computer's serial port

You can also import and export data to and from MATLAB.

These interfaces, also referred to as the MATLAB Application Program Interface (API), are documented in full in the online help. Use the following path to locate the help sections listed below.

```
MATLAB -> Using MATLAB -> External Interfaces/API
```

Calling C and Fortran Programs from MATLAB

MATLAB provides an interface to external programs written in the C and Fortran languages that enables you to interact with data and programs external to the MATLAB environment. This section explains how to call your own C or Fortran subroutines from MATLAB as if they were built-in functions.

Creating C Language MEX-Files

MATLAB callable C and Fortran programs are referred to as MEX-files. This section explains how to create and work with C MEX-files.

Creating Fortran MEX-Files

This section explains how to create and work with Fortran MEX-files.

Calling MATLAB from C and Fortran Programs

You can employ MATLAB as a computational engine that responds to calls from your C and Fortran programs. This section describes the MATLAB functions that allow you to:

- Start and end a MATLAB process
- Send commands to and exchange data with MATLAB
- Compile and link MATLAB engine programs

Calling Java from MATLAB

This section describes how to use the MATLAB interface to Java classes and objects. This MATLAB capability enables you to:

- Bring Java classes into the MATLAB environment
- Construct objects from those classes
- Work with Java arrays in MATLAB
- Call methods on Java objects, passing MATLAB or Java data types

Importing and Exporting Data

This section describes how to use MAT-files to import data to and export data from the MATLAB environment. MAT-files provide a convenient mechanism for moving your MATLAB data between different platforms in a highly portable manner. In addition, they provide a means to import and export your data to other stand-alone MATLAB applications.

ActiveX and DDE Support

MATLAB has interfaces that allow you to interact with ActiveX and Dynamic Data Exchange, (DDE). This section explains how to:

- Integrate ActiveX control components into an ActiveX control container such as a MATLAB figure window
- Use ActiveX Automation components to control or be controlled by MATLAB
- Enable access between MATLAB and other Windows applications using DDE

Serial Port I/O

This section describes the MATLAB serial port interface which provides direct access to peripheral devices such as modems, printers, and scientific instruments that you connect to your computer's serial port. This interface is established through a serial port object that allows you to:

- Configure serial port communications
- Use serial port control pins
- Write data to and read data from the device
- Execute an action when a particular event occurs
- Create a record of your serial port session

Reference Documentation

The online Help Reference section provides a detailed description of each of the MATLAB functions available in the MATLAB external interfaces. You can find this documentation in the online Help Contents by following the path shown here. Click on the page called External Interfaces/API Reference to see links to the sections listed below.

MATLAB -> Reference -> External Interfaces/API Reference

API Notes

An introduction to using the mex script, the MATLAB mxArray and other data types, and passing pointers in Fortran.

C Engine Routines

Functions that allow you to call MATLAB from your own C programs.

C MAT-File Routines

Functions that allow you to incorporate and use MATLAB data in your own C programs.

C MEX-Functions

Functions that you use in your C files to perform operations in the MATLAB environment.

C MX-Functions

Array access and creation functions that you use in your C files to manipulate MATLAB arrays.

Fortran Engine Routines

Functions that allow you to call MATLAB from your own Fortran programs.

Fortran MAT-File Routines

Functions that allow you to incorporate and use MATLAB data in your own Fortran programs.

Fortran MEX-Functions

Functions that you use in your Fortran files to perform operations in the MATLAB environment.

Fortran MX-Functions

Array access and creation functions that you use in your Fortran files to manipulate MATLAB arrays.

Java Interface Functions

Functions that enable you to create and interact with Java classes and objects from MATLAB.

ActiveX Functions

Functions that create ActiveX objects and manipulate their interfaces.

DDE Functions

Dynamic Data Exchange functions that enable MATLAB to access other Windows applications and vice versa.

Serial Port I/O Functions

Functions that enable you to interact with devices connected to your computer's serial port.

Symbols

- ! function 3-12
- %
 - for comment lines 17-11
 - for H1 and help text lines 17-10
- & 17-29
- ... in functions 3-5
- ./ref/#performance 8-2
- ; after functions 3-9
- >> prompt in Command Window 3-2
- @ 21-1
- | 17-29
- ~ 17-29
- ~= 17-28

A

- absolute accuracy
 - BVP 15-78
 - ODE 15-19
- accelerators, keyboard 2-18
- access modes
 - HDF files 6-34
- Access program Web page 2-20
- accuracy of calculations 17-21
- ActiveX
 - entries for MATLAB 1-6
 - startup options for MATLAB 1-6
- adding
 - cells to cell arrays 20-21
 - fields to structure arrays 20-10
- additional parameters
 - BVP example 15-68, 15-72
 - ODE example 15-13
- addpath 5-17
- adjacency matrix 16-17
 - and graphing 16-17

- Bucky ball 16-18
 - defined 16-17
 - distance between nodes 16-22
 - node 16-17
 - numbering nodes 16-19
- aggregation 22-37
- airflow modeling 16-23
- amp1dae demo 15-5
- analytical partial derivatives (BVP) 15-79
- AND operator, rules for evaluating 17-30
- ans 17-21
- answer, assigned to ans 17-21
- arguments
 - checking number of 17-14
 - defined for function 17-9
 - order
 - varargin, varargout 17-16, 17-18
 - passing 17-14
 - passing by reference 17-14
 - passing by value 17-14
 - passing variable number 17-16
- arithmetic expressions 17-26
- arithmetic operators
 - overloading 22-29
 - using 17-26
- Array Editor 5-10
 - preferences 5-12
- arrays
 - cell array of strings 18-8
 - character 18-5
 - dimensions
 - inverse permutation 19-13
 - editing 5-10
 - indexing 17-51
 - multidimensional 19-3
 - numeric

- converting to cell array 20-30
 - of strings 18-6
 - storage 17-51
 - workspace 5-3
- arrow keys for editing commands 3-8
- ASCII data
- definition of 6-2
 - exporting 6-16, 6-18
 - exporting delimited data 6-17
 - formats 6-4
 - importing 6-4
 - importing delimited files 6-12
 - importing mixed alphabetic and numeric data 6-14
 - importing space-delimited data 6-11
 - saving 6-17
 - table of format samples 6-10
 - using the Import Wizard with 6-4
 - with text headers 6-10, 6-13
- ASCII files
- reading formatted text 6-59
 - specifying delimiter 6-12
 - viewing contents of 5-27
 - writing 6-61
- assignment statements
- building structure arrays with 20-5
 - local and global variables 17-19
- attributes
- HDF files 6-35, 6-47
- Audio/Video Interleave format
- saving graphs 6-27
- autoinit cells
- converting input cells to 10-26
 - converting to input cell 10-27
 - defining 10-10
- AutoInit style
- definition of 10-19
- automatic scalar expansion 17-27
- automation startup option (automation server) 1-6
- AVI. *See* Audio/Video Interleave format
- B**
- ballode demo 15-41
- bandwidth of sparse matrix, reducing 16-29
- bang (!) function 3-12
- base (numeric), converting 18-15
- base date 17-63
- base number conversion 18-4
- base workspace 5-8
- Basic Fitting interface 13-31
- batch mode for starting MATLAB 1-6
- batonode demo 15-5
- bicubic interpolation 12-13
- bilinear interpolation 12-13
- binary data
- exporting 6-25
 - importing 6-20
 - using the Import Wizard 6-20
- binary files
- controlling data type of values read 6-54
 - writing to 6-55
- binary from decimal conversion 18-15
- blank spaces in MATLAB commands 3-4
- blanks
- finding in string arrays 18-12
 - removing from strings 18-7
- bookmarks in Help browser 4-15
- boundary conditions
- BVP 15-59
 - BVP example 15-65
 - PDE 15-84
 - PDE example 15-89

- Boundary Value Problems. *See* BVP
 - break long lines 3-5
 - breakpoints
 - clearing 7-30
 - description 7-18
 - setting 7-22
 - Bring MATLAB to Front command 10-26
 - Brusselator system (ODE example) 15-38
 - brussode demo 15-38
 - Buckminster Fuller dome 16-18
 - Bucky ball 16-18
 - bugs, reporting to The MathWorks 4-32
 - burgersode demo 15-5
 - BVP 15-57
 - defined 15-59
 - rewriting problem as first-order system 15-64
 - BVP solver 15-60
 - additional known parameters 15-63
 - basic syntax 15-61
 - evaluate solution at specific points 15-68
 - examples
 - boundary condition at infinity (shockbvp) 15-72
 - Mathieu's Equation (mat4bvp) 15-63
 - rapid solution changes (shockbvp) 15-68
 - initial guess 15-68
 - performance 15-75
 - representing problems 15-63
 - unknown parameters 15-67
 - BVP solver properties 15-76
 - analytical partial derivatives 15-79
 - bvpset function 15-76
 - error tolerance 15-77
 - mesh 15-80
 - modifying property structure 15-77
 - querying property structure 15-77
 - solution statistics 15-81
 - vectorization 15-78
- ## C
- C++ and MATLAB OOP 22-8
 - caching
 - MATLAB directory 5-14, 17-6
 - MATLAB/toolbox directory 17-6
 - M-files 5-14
 - toolbox path 1-10
 - calc zones
 - defining 10-10
 - ensuring workspace consistency in M-books 10-7
 - evaluating 10-14
 - output from 10-15
 - calling context 17-14
 - calling MATLAB functions
 - compiling for later use 17-13
 - how MATLAB searches for functions 17-12
 - storing as pseudocode 17-13
 - canonical class 22-9
 - capitalization in MATLAB 3-4
 - case 17-37
 - case conversion 18-3
 - case sensitivity in MATLAB 3-4
 - cat 16-26, 19-2, 19-7, 19-18
 - catch
 - for error handling 17-59
 - cell
 - indexing 20-20
 - accessing a subset of cells 20-24
 - cell arrays 20-19
 - accessing a subset of cells 20-24
 - accessing data 20-23
 - applying functions to 20-27
 - cell indexing 20-20

- concatenating 20-22
 - content indexing 20-21
 - converting to numeric array 20-30
 - creating 20-20
 - using assignments 20-20
 - with `cells` function 20-23
 - with curly braces 20-22
 - deleting cells 20-24
 - deleting dimensions 20-24
 - displaying 20-21
 - expanding 20-21
 - flat 20-29
 - indexing 20-21
 - multidimensional 19-18
 - nested 20-29
 - building with the `cells` function 20-29
 - indexing 20-30
 - of strings 18-8
 - comparing strings 18-11
 - of structures 20-31
 - organizing data 20-27
 - overview 20-19
 - preallocating 17-73, 20-23
 - replacing comma-separated list with 20-25
 - reshaping 20-25
 - visualizing 20-21
- cell data type 17-24
 - cell groups
 - converting to input cells 10-32
 - creating 10-9
 - definition of 10-8, 10-28
 - evaluating 10-13
 - output from 10-13
 - cell markers
 - defined 10-8
 - hiding 10-31
 - printing 10-18
 - `celldisp` 20-21
 - `cellplot` 20-21
 - cells
 - building nested arrays with 20-29
 - preallocating empty arrays with 20-20, 20-23
 - char data type 6-55, 17-24
 - character arrays 18-5
 - categorizing characters of 18-12
 - comparing 18-10
 - comparing values on cell arrays 18-11
 - concatenating 17-54
 - conversion 18-3, 18-15
 - converting to cell arrays 18-8
 - creating 18-5
 - delimiting character 18-13
 - evaluating 17-54, 18-16
 - finding a substring 18-13
 - functions that test 18-2
 - in cell arrays 18-8
 - operations 18-3
 - padding for equal row length 18-6
 - removing trailing blanks 18-7
 - representation 18-5
 - scalar 18-11
 - searching and replacing 18-13
 - token 18-13
 - two-dimensional 18-6
 - using relational operators on 18-11
 - characteristic polynomial of matrix 12-5
 - characteristic roots of matrix 12-5
 - characters
 - corresponding ASCII values 18-7
 - finding in string 18-12
 - characters per line, maximum 3-5
 - `checkin` 9-8
 - checking in files 9-7
 - checking out files 9-9

- undoing 9-10
- checkout 9-10
- chol 16-26, 16-33
- Cholesky factorization 11-25
 - for sparse matrices 16-33
- class directories 22-7
- class function 22-11
- classes 17-22
 - clearing definition 22-7
 - constructor method 22-10
 - debugging 22-6
 - designing 22-9
 - Java 17-24
 - methods required by MATLAB 22-9
 - object-oriented methods 22-3
 - overview 22-3
- clc 3-9
- clear 5-8, 17-13, 17-74
- ClearCase view 9-6
- clearing
 - Command Window 3-9
- clicking on multiple items 2-19
- clipboard 2-20
 - importing binary data 6-20
- closest point searches
 - Delaunay triangulation 12-25
- closing
 - desktop tools 2-9
 - MATLAB 1-15
- closing files 6-52, 6-62
- cmopts 9-5
- colamd 16-29
- Collatz problem 7-18
- colmmd 16-29, 16-31
- colon operator 17-26
 - for multidimensional array subscripting 19-9
 - indexing a page with 19-15
 - scalar expansion with 19-5
 - to access subsets of cells 20-24
- color
 - general preferences 2-24
- color modes
 - for printing M-books 10-23
- color printing
 - of an M-book 10-18
- colors
 - Command Window preferences 3-16
 - indicators for syntax 3-5
- colperm 16-28
- column vector
 - indexing as 17-51
- comma to separate function arguments 17-9
- command flags 1-5
- Command History
 - copying entries from 3-19
 - deleting entries in 3-18
 - description 3-17
 - running functions from 3-18
- command line editing 3-6
- Command Window
 - bringing to the front in Notebook 10-26
 - clearing 3-9
 - description 3-2
 - editing in 3-6
 - help 4-3
 - paging of output in 3-10
 - preferences for 3-13
 - printing contents of 3-11
 - prompt 3-2
- commands
 - on multiple lines 3-5
 - running 3-2
 - to operating system 3-12
 - See also* functions

- comma-separated list
 - using cell arrays 20-25
- comments
 - color indicators 2-24
- comments in code 17-11
- comparing
 - sparse and full matrix storage 16-7
 - strings 18-10
- complex conjugate transpose operator 17-26
- complex values in sparse matrix 16-7
- computational functions
 - applying to cell arrays 20-27
 - applying to multidimensional arrays 19-14
 - applying to sparse matrices 16-25
 - applying to structure fields 20-10
 - in M-file 17-4
- computational geometry
 - multidimensional 12-27
 - two-dimensional 12-19
- computer 17-21
- computer type 17-21
- concatenating
 - cell arrays 20-22
 - matrices 17-50
 - strings 17-54
- condest 16-4
- conditional statements 17-14
- configuration management. *See* source control system
- configuration, desktop 2-7
- configuring Notebook 10-24
- console mode 3-15
- constructor methods 22-10
 - guidelines 22-10
 - using `class` in 22-11
- containment 22-37
- content indexing 20-21
 - to access cell contents 20-23
- content of M-files, searching 5-28
- contents of sparse matrix 16-13
- Contents tab in Help browser
 - description 4-9
 - synchronizing preference 4-23
 - synchronizing with display 4-10
- Contents.m file 17-5
- context menus 2-17
- continue 17-41
- continue long statements 3-5
- control keys for editing commands 3-8
- conv 20-26
- converter methods 22-20, 22-25
- converting
 - base numbers 18-4
 - cases of strings 18-3
 - dates 17-62
 - numbers 18-15
 - strings 18-3, 18-15
- converting Word document to M-book 10-5
- convex hulls
 - multidimensional 12-28
 - two-dimensional 12-21
- convolution 12-6
- correlation coefficients 13-11
- cos 17-7
- covariance 13-11
- creating
 - cell array 20-20
 - multidimensional array 19-4
 - sparse matrix 16-8
 - string array 18-6
 - strings 18-5
 - structure array 20-5
- cropping graphics
 - in M-books 10-22

- cross 19-14
- cubic interpolation
 - multidimensional 12-18
 - one-dimensional 12-12
- cubic spline interpolation 12-12
- curly braces
 - for cell array indexing 20-20, 20-22
 - to build cell arrays 20-22
 - to nest cell arrays 20-29
- current directory
 - at startup for MATLAB 1-3
 - changing 5-22
 - contents of 5-22
 - field in toolbar 5-20
 - relevance to MATLAB 5-20
 - tool 5-20
- Current Directory browser 5-20
 - preferences 5-30
- curve fitting 13-22
 - Basic Fitting interface 13-31
 - error bounds 13-30
 - exponential 13-27
 - polynomial 12-7, 13-22
- curves
 - computing length 14-19
- Cuthill-McKee, reverse ordering 16-29

- D**
- DAE
 - solution of 15-3
- data
 - type for input 6-54
- data analysis
 - column-oriented 13-8
- data class hierarchy 22-4
- data consistency
 - evaluating M-books 10-7
 - in an M-book 10-7
 - using calc zones in M-books 10-7
- data filtering. *See* filtering
- data fitting. *See* curve fitting
- data gridding
 - multidimensional 12-18
- data organization
 - cell arrays 20-27
 - multidimensional arrays 19-16
 - structure arrays 20-12
- data sets
 - .*See* HDF data sets
- data types 17-22
 - cell 17-24
 - char 17-24
 - classes 22-4
 - double 17-24
 - precision 6-55
 - double 6-55
 - reading files 6-54
 - single 17-23
 - sparse 17-24
 - sparse matrices 17-22
 - struct 17-24
 - uint 17-24
 - user-defined 22-4
 - UserObject 17-24
- data. *See also*
 - multivariate data
 - statistical data
 - univariate data
- datatip 7-27
- date 17-67
- datetime 17-64, 17-65
- dates
 - base 17-63

- conversions 17-64
- formats 17-62
- handling and converting 17-62
- number 17-63
- string, vector of input 17-65
- datestr 17-64, 17-65
- datevec 17-64
- dbclear 7-30
- dbstack 7-24
- dbstop 7-23
- deblank 18-7
- debugger
 - option for UNIX 1-7
- debugging
 - ending 7-30
 - example 7-18
 - M-files 7-2, 7-17
 - option for using functions 7-36
 - prompt 7-24
 - techniques 7-17
 - tool 7-18
- debugging class methods 22-6
- decimal places in output 3-10
- decimal representation
 - to binary 18-15
 - to hexadecimal 18-15
- decomposition
 - eigenvalue 11-35
 - Schur 11-37
 - singular value 11-39
- deconvolution 12-6
- default function 21-15
- defaults
 - preferences for MATLAB 2-21
 - setting in startup file for MATLAB 1-5
- Define Autoint Cell command 10-26
- Define Calc Zone command 10-27
- Define Input Cell command 10-27
- Delaunay multidimensional tessellations 12-30
- Delaunay triangulation 12-21
 - closest point searches 12-25
- delay-differential equations
 - with ODE solvers 15-55
- delete 5-25
- deleting
 - cells from cell array 20-24
 - fields from structure arrays 20-10
 - files 5-25
 - matrix rows and columns 17-49
- deletion operator 17-49
- delimiter in string 18-13
- delimiters, defined 6-9
- demos
 - accessing from Launch Pad 2-5
- density of sparse matrix 16-7
- derivatives
 - polynomial 12-6
- desktop
 - configuration 2-7
 - saving 2-7
 - description 2-2
 - font preferences for 2-23
 - layout, predefined options 2-16
 - starting without 1-8
 - tools
 - closing 2-9
 - opening 2-4
- windows
 - closing 2-9
 - docking 2-10
 - grouping together 2-14
 - moving 2-10
 - opening 2-4
 - sizing 2-9

- undocking 2-12
- determinant of matrix 11-21
- development environment for MATLAB 2-2
- diag 16-26
- diagonal
 - creating sparse matrix from 16-10
- diary 3-12, 6-18
- difference equations 13-40
- differential equations 15-1
 - boundary value problems for ODEs 15-57
 - initial value problems for ODEs and DAEs 15-3
 - partial differential equations 15-82
- differential-algebraic equations. *See* DAE
- dim argument for cat 19-7
- dimensions
 - deleting 20-24
 - permuting 19-12
 - removing singleton 19-11
- dir 5-22
- direct methods for systems of equations 16-36
- directories
 - adding to path 22-7
 - caching for MATLAB 5-14
 - class 22-7
 - Contents.m file 17-5
 - creating 5-24
 - deleting 5-25
 - help for 17-5
 - MATLAB
 - caching 17-6
 - private 17-45, 22-6
 - renaming 5-25
 - searching contents of 5-20
 - temporary 6-53

See also current directory, search path

- discrete Fourier transform. *See* Fourier transforms
- disp 20-17
- dispatch type 22-68
- dispatching priority 17-12
- display method 22-12
 - examples 22-13
- display pane in Help browser 4-17
- displaying
 - cell arrays 20-21
 - error and warning messages 17-60
 - field names for structure array 20-6
 - sparse matrices 16-15
- displaying output 3-9
- distance between nodes 16-22
- docking windows in desktop 2-10
- documentation
 - location preference for Help browser 4-22
 - printing 4-26
 - problems, reporting 4-32
 - viewing 4-17
- dot product 11-8
- double data type 17-24
- double precision 6-55
- double-precision matrix 17-22
- dragging in the desktop 2-20

E

- Earth Observing System (EOS)
 - See* EOS (Earth Observing System)
- echo
 - preferences setting 3-15
- edit 7-4
- editing
 - in Command Window 3-6
 - M-files 7-3

- \$nopcode>editor
 - See also* Editor/Debugger 3-6
- editor
 - accessing 17-5
 - for creating M-files 17-3, 17-5
 - setting as default 7-36
- editor external to MATLAB 7-36
- Editor, stand-alone (Windows) 7-6
- Editor/Debugger
 - description 7-3
 - example 7-18
 - indenting 7-3
 - preferences 7-35
 - See also* editor
- eig 19-15
- eigenvalues 11-35
 - of sparse matrix 16-39
- eigenvectors 11-35
- element-by-element organization for structures 20-15
- ellipsis (...) in functions 3-5
- else, elseif 17-35, 17-36
- Embed Figures in M-book check box 10-21
- embedding graphics
 - in M-book 10-21
- empty arrays
 - and if statement 17-37
 - and relational operators 17-29
 - and while loops 17-39
- empty matrices 17-57
- end method 22-18
- end of file 6-56
- ending MATLAB 1-15
- environment settings at startup 1-5
- EOS (Earth Observing System)
 - sources of information 6-29
- eps 17-21
- epsilon 17-21
- equal to operator 17-28
- error 17-8
- error bounds
 - curve fitting 13-30
- error messages
 - in Command Window 3-12
- error style
 - definition of 10-19
- error tolerance
 - BVP problems 15-77
 - effects of too large (ODE) 15-55
 - machine precision 15-53
 - ODE problems 15-18
- errors 17-59
 - color indicators 2-24
 - displaying 17-60
 - finding 7-17
 - handling 17-59
 - run-time 7-17
 - syntax 7-17
- eval
 - for error handling 17-59
- Evaluate Calc Zone command 10-28
- Evaluate Cell command 10-28
- Evaluate Loop command 10-29
- Evaluate Loop dialog box 10-15
- Evaluate M-Book command 10-30
- evaluating
 - string containing function name 17-54
 - string containing MATLAB code 18-16
 - string containing MATLAB expression 17-54
- evaluating a selection
 - Command History 3-18
 - Command Window 3-3
- evaluating M-books
 - ensuring data consistency 10-7

- event location (ODE) 15-29
 - advanced example 15-44
 - simple example 15-41
- examples
 - adjacency matrix (sparse) 16-17
 - airflow modeling 16-23
 - Bucky ball 16-18
 - checking number of function arguments 17-14
 - container class 22-54
 - for 17-40
 - function 17-8
 - if 17-36
 - in documentation, index of 4-10
 - inheritance 22-38
 - M-file for structure array 20-12
 - polynomial class 22-24
 - running from Help browser 4-19
 - script 17-7
 - second difference operator 16-9
 - sparse matrix 16-9, 16-17
 - switch 17-38
 - theoretical graph (sparse) 16-17
 - vectorization 17-71
 - while 17-39
- examples (BVP)
 - boundary condition at infinity (fsbvp) 15-72
 - Mathieu's Equation (mat4bvp) 15-63
 - rapid solution changes (shockbvp) 15-68
 - two solutions (twobvp) 15-58
- examples (DAE)
 - electrical circuit (amp1dae) 15-5
 - Robertson problem (hb1dae) 15-47
- examples (MATLAB PDE) 15-82
 - electrodynamics problem (pdex4) 15-94
 - simple PDE (pdex1) 15-88
- examples (ODE) 15-31
 - advanced event location (orbitode) 15-44
 - Brusselator system (brussode) 15-38
 - constant mass matrix (fem2ode) 15-5
 - finite element discretization (fem1ode) 15-35
 - nonstiff 15-11
 - rigid body (rigidode) 15-32
 - Robertson problem (hb1ode) 15-5
 - simple event location (ballode) 15-41
 - stiff 15-14
 - strongly state-dependent mass matrix (burgersode) 15-5
 - time-, state-dependent mass matrix (batonode) 15-5
 - van der Pol (vdpode) 15-33
- exclusive OR operator 17-31
- execution, pausing 17-69
- exiting MATLAB 1-15
- expanding
 - cell arrays 20-21
 - structure arrays 20-5
- exponential curve fitting 13-27
- exporting
 - ASCII data 6-16, 6-18
 - binary data formats 6-25
 - in HDF format 6-41
- exporting data, overview 6-2
- expressions
 - arithmetic 17-26
 - involving empty arrays 17-29
 - logical 17-29
 - most recent answer 17-21
 - overloading 22-21
 - relational 17-28
 - scalar expansion with 17-27
- ext startup option 1-7
- external program, running from MATLAB 17-70
- eye 16-25
 - derivation of the name 11-11

F

factorization 16-30

Cholesky 11-25

for sparse matrices 16-30

Cholesky 16-33

LU 16-30

triangular 16-30

Hermitian positive definite 11-26

incomplete 16-35

LU 11-26

partial pivoting 11-27

positive definite 11-25

QR 11-28

fast Fourier transform. *See* Fourier transforms

favorites in Help browser 4-15

fclose 6-52, 6-62

feedback to The MathWorks 4-32

fem1ode demo 15-35

fem2ode demo 15-5

feof 6-56

feval

using on function handles 21-3, 21-9

using on function name strings 21-28

fid

See file identifiers

fieldnames 20-6

fields 20-4, 20-5

accessing data within 20-7

accessing with `getfield` 20-9

adding to structure array 20-10

applying functions to 20-10

all like-named fields 20-11

assigning data to 20-5

assigning with `setfield` 20-9

deleting from structures 20-10

indexing within 20-8

names 20-6

size 20-10

writing M-files for 20-11

fields 20-6

file identifiers

clearing 6-62

file identifiers (fid) 6-52

file management system. *See* source control

system

filebrowser 5-20

files

ASCII

reading formatted text 6-59

beginning of 6-56

binary

controlling data type values read 6-54

closing 6-52, 6-62

contents, viewing 5-27

copying 5-25

creating in the Current Directory browser 5-24

current position 6-56

deleting 5-25

editing M-files 7-3

end of 6-56

failing to open 6-52

identifiers 6-52

log 1-6

MATLAB related, listing 5-22

naming 5-14

opening 5-26, 6-52

operations in MATLAB 5-20

permissions 6-52

position 6-56

renaming 5-25

running 5-27

source control 9-2

temporary 6-53

viewing contents of 5-27

- files, ASCII
 - reading 6-58
 - specifying delimiter 6-12
 - writing 6-61
- files, binary
 - data types 6-54
 - reading 6-54
 - writing to 6-55
- fill-in of sparse matrix 16-22
- filtering
 - difference equations 13-40
- Find & Replace feature in Current Directory
 - browser 5-28
- find function
 - and sparse matrices 16-16
 - and subscripting 17-32
- finding
 - M-file content 7-12
 - string in M-files 5-28
 - substring within a string 18-13
 - text in page of Help browser 4-19
- finish.m 1-15
- finishdlg.m 1-15
- finishsav.m 1-15
- finite differences 13-12
- finite element discretization (ODE example)
 - 15-35
- first-order differential equations
 - representation for BVP solver 15-64
 - representation for ODE solvers 15-11
- flags for startup 1-5
- float 6-55
- floating-point number
 - largest 17-21
 - smallest 17-21
- floating-point precision 6-55
- floating-point relative accuracy 17-21
- flow control 17-35
 - catch 17-42
 - continue 17-41
 - else 17-35
 - elseif 17-35
 - for 17-40
 - if 17-35
 - return 17-42
 - switch 17-37
 - try 17-42
 - while 17-39
- folders. *See* directories
- font
 - Help browser 4-24
 - Help browser display pane 4-25
 - Help Navigator 4-24
 - in Command Window 3-15
 - preferences in MATLAB 2-23
- fopen 6-52
 - failing 6-52
- for 17-40, 20-30
 - example 17-40
 - indexing 17-40
 - nested 17-40
 - syntax 17-40
- format
 - controlling numeric format in M-book 10-20
 - date 17-62
 - in Array Editor 5-12
 - preferences 3-14
- format 3-10
 - in M-book 10-20
- Fourier analysis 13-43
 - concepts 13-44
- Fourier transforms 13-43
 - calculating sunspot periodicity 13-45
 - FFT-based interpolation 12-13

- length vs. speed 13-50
- phase and magnitude of transformed data 13-49
- fragmentation, reducing 17-74
- fread 6-54
- frewind 6-56
- fsbvp demo 15-72
- fseek 6-56
- ftell 6-56
- full 16-26, 16-29
- full text searching in Help browser 4-13
- func2str
 - description 21-21
 - example 21-21
- function call history report 8-11
- function definition line 17-4, 17-9
 - for subfunction 17-43
- function details report 8-10
- function functions 14-1
- function handles 17-24, 21-1
 - benefits of 21-3
 - constructing 21-7
 - converting from function name string 21-22
 - converting to function name string 21-21
 - effect on performance 21-5
 - error conditions 21-26
 - evaluating a nonscalar function handle 21-27
 - including path in the constructor 21-26
 - nonexistent function 21-26
 - evaluating 21-9
 - finding the binding functions 21-13
 - for subfunctions, private functions 21-4
 - maximum name length 21-7
 - operations on 21-21
 - overloading 21-3, 21-9, 21-18
 - overview of 21-2
 - passing 21-3
 - saving and loading 21-25
 - testing for data type 21-23
 - testing for equality 21-23
- types
 - constructor 21-18
 - overloaded 21-18
 - private 21-20
 - simple 21-17
 - subfunction 21-19
- function name string
 - converting from function handle 21-21
 - converting to function handle 21-22
- function workspace 5-8, 17-14
- functions 17-8
 - applying
 - to multidimensional structure arrays 19-20
 - to structure contents 20-10
 - applying to cell arrays 20-27
 - arguments
 - passing variable number of 17-16
 - body 17-4, 17-10
 - calling 17-13
 - calling context 17-14
 - characteristics 17-3
 - class 22-11
 - clearing from memory 17-13
 - color indicators 2-24
 - computational, applying to structure fields 20-10
 - contents 17-9
 - converters 22-25
 - creating arrays with 19-6
 - default 21-15
 - dispatching priority 17-12
 - example 17-8
 - executing function name string 17-54

- help for 4-28
 - reference page 4-3
 - searching 4-13
 - inferiorto 22-66
 - isa 22-11
 - logical 17-31
 - long (on multiple lines) 3-5
 - mathematical. *See* mathematical functions
 - maximum number of characters in 3-5
 - multiple in one line 3-4
 - multiple output values 17-9
 - naming 5-14, 17-11
 - resolution 17-12
 - nested 17-75
 - optimization 17-71
 - optimizing 14-9
 - order of arguments
 - varargin, varargout 17-16, 17-18
 - overloaded 4-29
 - overloaded methods 21-16
 - overloading 22-21, 22-23, 22-31
 - primary 17-43
 - private 17-45
 - running 3-2
 - sequence report 8-11
 - sharing same name 4-29
 - storing as pseudocode 17-13
 - subassign 22-17
 - subfunction 17-43
 - suboref 22-14
 - superiorto 22-66
 - time used report 8-10
 - which 22-70
- functions command
- description 21-13
 - for constructor function handles 21-18
 - for overloaded function handles 21-18
 - for private function handles 21-20
 - for simple function handles 21-17
 - for subfunction handles 21-19
 - return fields 21-14
- fwrite 6-55
- ## G
- Gaussian elimination 11-26
 - geodesic dome 16-18
 - geometric analysis
 - multidimensional 12-27
 - two-dimensional 12-19
 - get method 22-13
 - getfield 20-9
 - global attributes
 - HDF files 6-35
 - global minimum 14-15
 - global variables 17-19
 - rules for use 17-20
 - gplot 16-18
 - graph
 - characteristics 16-21
 - defined 16-17
 - theoretical 16-17
 - graphics
 - controlling output in M-book 10-21
 - embedding in M-book 10-21
 - in M-books 10-20
 - graphing
 - variables from the Workspace browser 5-9
 - greater than operator 17-28
 - greater than or equal to operator 17-28
 - Group Cells command 10-30

H

H1 line 17-4, 17-10

 and `help` command 17-4

 and `lookfor` command 17-4

`hb1dae` demo 15-47

`hb1ode` demo 15-5

HDF (Hierarchical Data Format)

 calling conventions 6-31

 exporting data 6-41

 importing into MATLAB 6-33

 MATLAB support 6-30

 MATLAB utility API 6-49

 NCSA documentation 6-29

 output arguments 6-32

 overview 6-29

 programming model 6-33

 symbolic constants 6-32

HDF data sets

 accessing 6-36

 associating attributes with 6-47

 attributes 6-38

 closing access 6-46

 creating 6-43

 getting information about 6-37

 reading 6-39

 using predefined attributes 6-48

 writing attributes 6-48

HDF files

 access modes 6-34

 associating attributes with 6-47

 closing 6-46

 closing all open identifiers 6-50

 creating 6-42

 getting information about 6-34

 listing open identifiers 6-49

 opening 6-34

 reading global attributes 6-35

 writing attributes 6-48

 writing data 6-44

HDF-EOS

 Earth Observing System 6-29

headers, printing with M-files 7-43

help

 from Editor/Debugger 7-5

 functions 4-28

 in Command Window 4-29

 MATLAB 4-2

 M-file 4-3

 subset for specified products 4-7

`help` 4-29, 17-10

 and H1 line 17-4

Help browser

 contents listing 4-9

 copying information from 4-19

 description 4-4

 display pane 4-17

 favorites (bookmarks) 4-15

 font preferences 4-24

 index 4-11

 navigating 4-18

 preferences 4-21

 printing help 4-26

 running examples from 4-19

 searching 4-13

 Web pages, viewing 4-20

Help Navigator 4-5

help text 17-4

`helpbrowser` 4-4

Hermitian positive definite matrix 11-26

hexadecimal, converting from decimal 18-15

Hide Cell Markers command 10-31

Hierarchical Data Format (HDF).

See HDF

hierarchy of data classes 22-4

- history of functions called 8-11
- history, automatic log file 1-6
- home 3-9
- HTML
 - source, viewing in Help browser 4-20
 - viewer 4-4
- I**
- identity matrix 11-11
- if 17-35
 - and empty arrays 17-37
 - example 17-36
 - nested 17-36
- imaginary unit 17-21
- Import Data option 6-20
- import functions
 - comparison of features 6-11
- Import Wizard
 - importing binary data 6-20
 - with ASCII data 6-4
- importing
 - ASCII data 6-4
 - binary data 6-20
 - HDF data 6-33
 - MAT-file data 6-23
 - sparse matrix 16-12
 - spreadsheet data 6-23
- importing data
 - Import Wizard 6-4
 - overview 6-2
- incomplete factorization 16-35
- indenting 7-9, 7-40
- indenting for syntax 3-5
- index
 - examples in documentation 4-10
 - Help browser 4-11
 - results 4-12
 - tips 4-12
- indexed reference 22-14
- indexing 17-46
 - advanced 17-51
 - cell array 20-20
 - content 20-21
 - for loops 17-40
 - multidimensional arrays 19-9
 - nested cell arrays 20-30
 - nested structure arrays 20-18
 - structures within cell arrays 20-32
 - within structure fields 20-8
- indices, how MATLAB calculates 17-53
- Inf 17-21
- infeasible optimization problems 14-15
- inferiorto function 22-66
- infinity (represented in MATLAB) 17-21
- inheritance
 - example class 22-38
 - multiple 22-36
 - simple 22-35
- initial conditions
 - ODE 15-6
 - ODE example 15-12
 - PDE 15-84
 - PDE example 15-89
- initial guess (BVP)
 - example 15-65
 - quality of 15-68
- initial value problems 15-3
 - defined 15-6
- initial-boundary value problems 15-82
- initiation (init) file for MATLAB 1-5
- inline objects
 - representing mathematical functions 14-4
- inner product 11-7

input

- from keyboard 17-69
- obtaining from M-file 17-69

input cells

- controlling evaluation of 10-15
- controlling graphic output 10-21
- converting autoinit cell to 10-27
- converting text to 10-27
- converting to autoinit cell 10-26
- converting to cell groups 10-32
- converting to text 10-11
- defining in M-books 10-8
- evaluating 10-12
- evaluating cell groups 10-13
- evaluating in a loop 10-15
- maintaining consistency 10-6
- timing out during evaluation 10-29
- use of Word Normal style 10-11

input for MATLAB 3-2**Input style**

- definition of 10-19

integer data type 6-60**integers, changing to strings 18-15****integration**

- double 14-20
- numerical 14-19
- See also* differential equations

integration interval (ODE solvers) 15-9**interactive user input 17-69****interpolation 12-10**

- comparing methods graphically 12-14
- FFT-based 12-13
- multidimensional 12-17
 - scattered data 12-35
- one-dimensional 12-11
- speed, memory, smoothness 12-12
- three-dimensional 12-17

two-dimensional 12-13**interrupting a running program 3-11****inverse of matrix 11-21****inverse permutation of array dimensions 19-13****ipermute 19-2, 19-13****isa 22-11**

- using with function handles 21-23

isempty 17-29**isequal**

- using with function handles 21-23

isinf 17-32**isnan 17-32****iterative methods**

- for sparse matrices 16-38
- for systems of equations 16-36

J**Jacobian matrix (ODE) 15-23**

- generating sparse numerically 15-24

- specifying 15-24

- vectorizing ODE function 15-25

Java and MATLAB OOP 22-8**Java VM**

- starting without 1-9

K**K>> prompt in Command Window 3-3****key bindings 7-40****keyboard 7-18****keyboard shortcuts and accelerators 2-18****keys for editing in Command Window 3-8****keywords**

- in documentation 4-11

keywords, color indicators 2-24**Kronecker tensor matrix product 11-11**

L

- lasterr 17-59
 - and error handling 17-59
 - Launch Pad 2-5
 - least squares 16-34
 - length of curve, computing 14-19
 - less than operator 17-28
 - less than or equal to operator 17-28
 - license information 4-32
 - line numbers 7-11
 - line numbers, printing with M-files 7-43
 - line wrapping 3-15
 - linear algebra 11-5
 - linear equations
 - minimal norm solution 11-23
 - overdetermined systems 11-15
 - rectangular systems 11-22
 - solving systems of 11-13
 - underdetermined systems 11-18
 - linear interpolation
 - multidimensional 12-18
 - one-dimensional 12-11
 - linear systems of equations
 - direct methods 16-36
 - iterative methods 16-36
 - sparse 16-36
 - linear transformation 11-5
 - lines, maximum number of characters in 3-5
 - load 5-7, 16-12, 17-74
 - function handles 21-25
 - loading data, overview 6-2
 - loading objects 22-60
 - loadobj example 22-62
 - Lobatto IIIa BVP solver 15-60
 - local variables 17-19
 - locking files 9-9
 - log
 - automatic, for MATLAB 1-6
 - file 1-6
 - functions 3-17
 - session 3-12
 - logfile startup option 1-6
 - logical expressions 17-29
 - and subscripting 17-32
 - logical functions 17-31
 - logical operators 17-29
 - rules for evaluation 17-30
 - long 6-55
 - long integer 6-55
 - lookfor 5-30, 17-4, 17-10
 - and H1 line 17-4
 - looping
 - to evaluate input cells 10-15
 - loops
 - for 17-40
 - while 17-39
 - Lotus 123
 - importing 6-23
 - lowercase usage in MATLAB 3-4
 - lu 16-30, 16-32
 - LU factorization 11-26
 - for sparse matrices and reordering 16-31
-
- M**
- mass matrix (ODE) 15-27
 - initial slope 15-29
 - singular 15-29
 - sparsity pattern 15-28
 - specifying 15-28
 - state dependence 15-28
 - mat4bvp demo 15-58
 - mat4bvp demo 15-63
 - MAT-files

- creating 5-5
- defined 5-5
- importing data from 6-23
- loading 5-7
- mathematical functions
 - as function input arguments 14-2
 - finding zeros 14-12
 - minimizing 14-9
 - numerical integration 14-19
 - plotting 14-6
 - representing in MATLAB 14-4
- mathematical operations on sparse matrices 16-25
- Mathieu's equation (BVP example) 15-63
- MATLAB
 - data type classes 22-4
 - files, listing 5-22
 - help for 4-2
 - path 5-14
 - programming
 - functions 17-8
 - M-files 17-3
 - quick start 17-3
 - scripts 17-7
 - prompt 3-2
 - quitting 1-15
 - structures 22-8
 - version 17-21
 - window 2-2
- MATLAB commands
 - executing in a Word document 10-12
- matlab.mat 5-6
- matlabrc.m 1-5
- matlabroot 1-3
- matrices 11-5
 - accessing multiple elements 17-47
 - accessing single elements 17-46
 - advanced indexing 17-51
 - as linear transformation 11-5
 - characteristic polynomial 12-5
 - characteristic roots 12-5
 - concatenating 17-50
 - creation 11-5
 - deleting rows and columns 17-49
 - determinant 11-21
 - editing 5-10
 - empty 17-57
 - expanding 17-48
 - full to sparse conversion 16-3, 16-7
 - identity 11-11
 - inverse 11-21
 - orthogonal 11-28
 - pseudoinverse 11-22
 - rank deficiency 11-17
 - sparse 17-22
 - symmetric 11-8
 - triangular 11-25
- matrix
 - as index for for loops 17-40
 - double-precision 17-22
 - iterative methods 16-38
 - power operator 17-27
 - single-precision 17-22
 - See also* matrices
- matrix operations
 - addition and subtraction 11-7
 - division 11-13
 - exponentials 11-33
 - multiplication 11-9
 - powers 11-32
 - transpose 11-8
- matrix products
 - Kronecker tensor 11-11
- max 16-26

M-books

- creating 10-3
- cropping graphics 10-22
- ensuring data consistency 10-7
- entering text and commands 10-6
- evaluating all input cells in 10-15
- modifying style template 10-18
- opening 10-5
- printing 10-18
- protecting data integrity 10-6
- sizing graphic output 10-22

mean 19-14

measuring performance of M-files 8-2

meditor 7-6

memory

- allocating for variables 17-76
- function workspace 17-14
- management 17-74
- Out of Memory message 17-78
- reducing fragmentation 17-74

mesh size (BVP) 15-80

methods 22-3

- converters 22-20
- determining which is called 22-70
- display 22-12
- end 22-18
- get 22-13
- invoking on objects 22-5
- listing 22-33
- overloaded 21-16
- precedence 22-67
- required by MATLAB 22-9
- set 22-13
- subsasgn 22-14
- subsref 22-14

M-file help 4-3

- viewing in Current Directory browser 5-27

M-files

- changes recognized 5-14
- comments 17-11
- content, viewing 5-27
- contents 17-4
- corresponding to functions 22-22
- creating
 - from Command History 3-19
 - in MATLAB directory 17-6
 - in MATLAB directory tree 17-6
 - overview 7-2
 - quick start 17-3
 - warning 5-14
- creating with text editor 17-5
- debugging 7-2, 7-17
- dispatching priority 17-12
- editing 7-2, 7-3
- file association (Windows) 7-6
- input
 - keyboard 17-69
 - obtaining interactively 17-69
- kinds 17-3
- location of 5-14
- naming 5-14, 17-2
- opening 7-5
- operating on structures 20-11
- optimization 17-71
- overview 17-4
- pausing 7-18
- pausing during execution 17-69
- performance of 8-2
- primary function 17-43
- printing 7-16
- printing, preferences 7-42
- profiling 8-2
- replacing content 7-12
- replacing string in 5-28

- representing mathematical functions 14-4
- running
 - Command Window 3-11
 - from Current Directory browser 5-27
- running at startup 1-6
- saving 7-15
- search path 5-14
- searching contents of 5-28
- source control 9-2
- subfunction 17-43
- superseding existing names 17-44
- viewing description 5-31
- Microsoft Excel
 - importing 6-23
- Microsoft Windows
 - MATLAB use of system resources 17-77
- Microsoft Word
 - converting document to M-book 10-5
 - specifying version and location 10-24
- minimize startup option 1-6
- minimizing mathematical functions
 - of one variable 14-9
 - of several variables 14-10
 - options 14-11
- minimum degree ordering 16-29
- mislocked 17-20
- mkdir 5-24
- mlock 17-20
- model files
 - source control 9-2
- models
 - interfacing with source control systems 9-2
- Moore-Penrose pseudoinverse 11-22
- more 3-10
- mouse, right-clicking 2-17
- movies
 - saving in AVI format 6-27
- multidimensional arrays 19-2
 - applying functions 19-14
 - element-by-element functions 19-14
 - matrix functions 19-15
 - vector functions 19-14
 - cell arrays 19-18
 - computations on 19-14
 - creating 19-4
 - at the command line 19-4
 - with functions 19-6
 - with the cat function 19-7
 - extending 19-5
 - format 19-8
 - indexing 19-9
 - avoiding ambiguity 19-9
 - with the colon operator 19-9
 - number of dimensions 19-8
 - organizing data 19-16
 - permuting dimensions 19-12
 - removing singleton dimensions 19-11
 - reshaping 19-10
 - size of 19-8
 - storage 19-8
 - structure arrays 19-19
 - applying functions 19-20
 - subscripts 19-3
- multidimensional data gridding 12-18
- multidimensional interpolation 12-17
 - scattered data 12-27
- multiple conditions for switch 17-38
- multiple inheritance 22-36
- multiple item selection 2-19
- multiple lines for functions 3-5
- multiple output values 17-9
- multiprocessing 3-3
- multistep solver (ODE) 15-7
- multivariate data

- matrix representation 13-4
- vehicle traffic sample data 13-4

munlock 17-20

N

names

- function 17-11
- structure fields 20-6
- superseding 17-44
- variable 17-19

naming functions and variables 5-14

NaN 17-21

NaNs

- propagation 13-14
- removing from data 13-15

nargin 17-14

nargout 17-14

ndgrid 19-2

ndims 19-2, 19-8

nearest neighbor interpolation

- multidimensional 12-18
- one-dimensional 12-11
- three-dimensional 12-17
- two-dimensional 12-13

nesting

- cell arrays 20-29
- for loops 17-40
- functions 17-75
- if statements 17-36
- structures 20-17

newlines in string arrays 18-12

nnz 16-13, 16-15

nodes 16-17

- distance between 16-22
- numbering 16-19

nodesktop startup option 1-8

nojvm startup option 1-9

nonstiff ODE examples

- rigid body (rigidode) 15-32

nonzero elements

- number of 16-13

nonzero elements of sparse matrix 16-13

- maximum number in sparse matrix 16-9

- storage 16-6, 16-13

- values 16-13

- visualizing with spy plot 16-21

nonzeros 16-13

Normal style (Microsoft Word)

- default style in M-book 10-18

- defaults 10-19

- used in undefined input cells 10-11

normal.dot 10-25

normalizing data 13-23

norms

- vector and matrix 11-12

nosplash startup option 1-9

not equal to operator 17-28

NOT operator

- rules for evaluating 17-30

Not-a-Number 17-21

Notebook

- configuring 10-24

- overview 10-2

notebook command

- set up 10-24

- using 10-3

Notebook menu

- in Word menu bar 10-3

Notebook Options command 10-31

now 17-68

number of arguments 17-14

numbering lines 7-11

numbers

- changing to strings 18-15
- date 17-63
- time 17-63
- numeric format
 - controlling in M-book 10-20
 - output 3-10
 - preferences 3-14
- numerical integration 14-19
 - computing length of curve 14-19
 - double 14-20
- nzmax 16-13, 16-15

O

- objective function 14-2
 - return values 14-15
- object-oriented programming 22-2
 - converter functions 22-25
 - features of 22-3
 - inheritance
 - multiple 22-36
 - simple 22-35
 - overloading 22-21, 22-23
 - subscripting 22-14
 - overview 22-3
 - See also* classes and objects
- objects
 - accessing data in 22-13
 - as indices into objects 22-19
 - creating 22-4
 - invoking methods on 22-5
 - loading 22-60
 - overview 22-3
 - precedence 22-65
 - saving 22-60
- ODE
 - coding in MATLAB 15-11

- defined 15-6
- overspecified systems 15-51
- rewriting problem as first-order system 15-11
- solution of 15-3
- ODE solver
 - evaluate solution at specific points 15-16
- ODE solver properties 15-16
 - error tolerance 15-18
 - event location 15-29
 - fixed step sizes 15-52
 - Jacobian matrix 15-23
 - mass matrix 15-27
 - modifying property structure 15-17
 - ode15s 15-30
 - odeset function 15-17
 - querying property structure 15-18
 - solver output 15-20
 - step size 15-25
- ODE solvers 15-6
 - algorithms
 - Adams-Bashworth-Moulton PECE 15-7
 - Bogacki-Shampine 15-7
 - Dormand-Prince 15-7
 - modified Rosenbrock formula 15-8
 - numerical differentiation formulas 15-8
 - backward differentiation formulas 15-30
 - backwards in time 15-55
 - basic example
 - nonstiff problem 15-11
 - stiff problem 15-14
 - basic syntax 15-8
 - calling 15-12
 - examples 15-31
 - minimizing output storage 15-51
 - minimizing startup cost 15-52
 - multistep solver 15-7
 - nonstiff problems 15-7

- numerical differentiation formulas 15-30
- obtaining solutions at specific times 15-9
- one-step solver 15-7
- overview 15-6
- passing additional parameters 15-10
- performance 15-16
- problem size 15-51
- representing problems 15-10
- sampled data 15-54
- stiff problems 15-7, 15-14
- troubleshooting 15-50
- variable order solver 15-30
- odephas2 output function 15-21
- odephas3 output function 15-21
- odeplot output function 15-21
- odeprint output function 15-21
- offsets for indexing 17-53
- one-dimensional interpolation 12-11
- ones 16-25, 17-48, 19-6
- one-step solver (ODE) 15-7
- online help 17-10
- open 5-26, 7-5
- opening
 - files
 - Current Directory browser 5-26
- opening files 6-52
 - failing 6-52
 - HDF 6-34
 - permissions 6-52
- openvar 5-11
- operating system commands 3-12
- operator
 - second difference 16-9
- operator precedence 17-32
 - overriding 17-33
- operators 17-26
 - & 17-29
 - | 17-29
 - ~ 17-29
- applying to cell arrays 20-27
- applying to structure fields 20-10
- arithmetic 17-26
- colon 17-26, 19-5, 19-9, 19-15, 20-24
- complex conjugate 17-26
- deletion 17-49
- equal to 17-28
- greater than 17-28
- greater than or equal to 17-28
- less than 17-28
- less than or equal to 17-28
- logical 17-29
- matrix power 17-27
- not equal to 17-28
- overloading 22-3, 22-21
- power 17-26
- relational 17-28
- subtraction 17-26
- table of 22-22
- unary minus 17-26
- optimization 14-9, 17-71
 - calling sequence changes (Version 5) 14-17
 - helpful hints 14-15
 - options parameters 14-11
 - preallocation, array 17-73
 - troubleshooting 14-15
 - vectorization 17-71
 - See also* minimizing mathematical functions
- optimization code
 - updating to MATLAB Version 5 syntax 14-16
- optimizing performance of M-files 8-2
- options
 - shutdown 1-15
- orbitode demo 15-44
- Ordinary Differential Equations. *See* ODE

- organizing data
 - cell arrays 20-27
 - multidimensional arrays 19-16
 - structure arrays 20-12
 - orthogonal matrix 11-28
 - Out of Memory message 17-78
 - outer product 11-7
 - outliers
 - removing from statistical data 13-15
 - output
 - Command Window 3-10
 - display format 3-10
 - MATLAB 3-2
 - not displaying 3-9
 - spaces per tab 3-14
 - spacing of 3-14
 - output cells
 - converting to text 10-16
 - purging 10-17
 - output points (ODE)
 - increasing number of 15-22
 - output properties (ODE) 15-20
 - increasing number of output points 15-22
 - output storage
 - minimizing for ODE problems 15-51
 - Output style
 - definition of 10-19
 - overdetermined
 - rectangular matrices 11-15
 - overloaded functions 4-29
 - overloading 22-14
 - arithmetic operators 22-29
 - functions 22-21, 22-23, 22-31
 - loadobj 22-61
 - operators 22-3
 - pie3 22-57
 - saveobj 22-61
 - overspecified ODE systems 15-51
- P**
- pack 17-74
 - page subscripts 19-3
 - paging in the Command Window 3-10
 - parentheses
 - for input arguments 17-9
 - overriding operator precedence with 17-33
 - Partial Differential Equations. *See* PDE
 - partial fraction expansion 12-8
 - passing arguments
 - by reference 17-14
 - by value 17-14
 - Paste Special option 6-20
 - path
 - adding directories to 5-23, 22-7
 - changing 5-17
 - description 5-14
 - order of directories 5-14
 - saving changes 5-18
 - viewing 5-17
 - pathdef.m 5-14, 5-19
 - pathtool 5-16
 - pausing during M-file execution 17-69
 - pausing execution of M-file 7-22
 - pcode 17-13
 - PCs and MATLAB use of system resources 17-77
 - PDE 15-82
 - defined 15-83
 - discretized 15-54
 - PDE solver (MATLAB) 15-84
 - additional known parameters 15-87
 - basic syntax 15-85
 - evaluate solution at specific points 15-93
 - examples

- electrodynamics problem 15-94
 - simple PDE 15-88
- performance 15-93
- representing problems 15-88
- PDE solver (MATLAB) properties 15-94
- pdex1 demo 15-88
- pdex2 demo 15-83
- pdex3 demo 15-83
- pdex4 demo 15-94
- pdex5 demo 15-83
- PDF
 - printing documentation files 4-26
 - reader, preference for Help browser 4-23
- percent sign (comments) 17-11
- performance
 - de-emphasizing an ODE solution component 15-53
 - improving for BVP solver 15-75
 - improving for M-files 8-2
 - improving for ODE solvers 15-16
 - improving for PDE solver 15-93
 - improving for startup 1-10
- permission string 6-52
- permutations 16-26
- permute 19-2, 19-12
- permuting array dimensions 19-12
 - inverse 19-13
- persistent variables 17-20
- pi 17-21
- pie3 function overloaded 22-57
- plane organization for structures 20-14
- plotting
 - mathematical functions 14-6
- plotting results 8-12
- polar 17-7
- polynomial
 - curve fitting 13-22
 - regression 13-18
- polynomial interpolation 12-11
- polynomials
 - basic operations 12-3
 - calculating coefficients from roots 12-4
 - calculating roots 12-4
 - curve fitting 12-7
 - derivatives 12-6
 - evaluating 12-5
 - example class 22-24
 - multiplying and dividing 12-6
 - partial fraction expansion 12-8
 - representing as vectors 12-4
- pop-up menus 2-17
- power operator 17-26
- preallocation 17-73
 - cell array 17-73, 20-23
 - structure array 17-74
- precedence
 - object 22-65
 - operator 17-32
 - overriding 17-33
- precision
 - char 6-55
 - data types 6-55
 - double 6-55
 - float 6-55
 - long 6-55
 - output display 3-10
 - short 6-55
 - single 6-55
 - uchar 6-55
- preconditioner for sparse matrix 16-35
- preferences
 - Command Window 3-13
 - general, MATLAB 2-23
 - MATLAB 2-21

- setting 2-21
 - toolbox caching 1-10
 - viewing 2-21
 - primary function 17-43
 - printing
 - Command Window contents 3-11
 - documentation 4-26
 - help 4-26
 - M-files 7-16
 - printing an M-book
 - cell markers 10-18
 - color 10-18
 - color modes 10-23
 - defaults 10-18
 - private directories 17-45
 - private directory
 - in dispatching priority 17-12
 - private functions 17-45
 - function handles to 21-4, 21-20
 - precedence of 22-69
 - private methods 22-6
 - problems, reporting to The MathWorks 4-32
 - product filter in Help browser 4-7
 - preference 4-23
 - profile 8-4
 - example 8-6
 - profiling 8-2
 - reports 8-7
 - programming, object-oriented 22-2
 - programs
 - running external 17-70
 - running from MATLAB 3-12
 - stopping while running 3-11
 - prompt
 - debugging type 7-24
 - prompt, in Command Window 3-2
 - property structure (BVP)
 - creating 15-76
 - modifying 15-77
 - querying 15-77
 - property structure (ODE)
 - creating 15-17
 - modifying 15-17
 - querying 15-18
 - pseudocode 17-13
 - pseudoinverse
 - of matrix 11-22
 - Purge Output Cells command 10-31
 - purging output cells 10-17
- Q**
- QR factorization 11-28, 16-33
 - quad, quad1
 - differ from ODE solvers 15-51
 - quadrature. *See* numerical integration
 - quit 17-74
 - quitting MATLAB 1-15
- R**
- rand 16-25
 - randn 19-6
 - rank 16-4
 - deficiency 16-34
 - rank deficiency
 - detecting 11-30
 - rectangular matrices 11-17
 - reading
 - HDF data 6-33
 - reading data from a disk file
 - overview 6-2
 - realmax 17-21
 - realmin 17-21

- recall, smart 3-7
 - rectangular matrices
 - identity 11-11
 - overdetermined systems 11-15
 - pseudoinverse 11-22
 - QR factorization 11-28
 - rank deficient 11-17
 - singular value decomposition 11-39
 - underdetermined systems 11-18
 - redo in MATLAB 2-17
 - reducing memory fragmentation 17-74
 - reference pages 4-3
 - reference, subscripted 22-14
 - regression
 - linear-in-the-parameters 13-19
 - multiple 13-21
 - polynomial 13-18
 - regserver startup option 1-6
 - relational operators
 - empty arrays 17-29
 - strings 18-11
 - relative accuracy
 - BVP 15-78
 - norm of ODE solution 15-19
 - ODE 15-19
 - removing
 - cells from cell array 20-24
 - fields from structure arrays 20-10
 - singleton dimensions 19-11
 - reorderings 16-26
 - and LU factorization 16-31
 - for sparser factorizations 16-28
 - minimum degree ordering 16-29
 - to reduce bandwidth 16-29
 - replacing M-file content 5-28
 - replacing substring within string 18-13
 - repmat 19-6
 - reports
 - function call history 8-11
 - function details 8-10
 - saving 8-13
 - summary 8-7
 - representing
 - mathematical functions 14-4
 - requirements 1-3
 - reshape 19-10, 20-25
 - reshaping
 - cell arrays 20-25
 - multidimensional arrays 19-10
 - residuals
 - analyzing 13-24
 - for exponential data fit 13-29
 - resizing windows in the desktop 2-9
 - results in MATLAB, displaying 5-11
 - return 17-42
 - revision control system. *See* source control system
 - rigid body (ODE example) 15-32
 - rigidode demo 15-32
 - rmfield 20-10
 - roadmap for documentation 4-10
 - Robertson problem
 - DAE example 15-47
 - ODE example 15-5
 - root directory for MATLAB 1-3
 - roots
 - polynomial 12-4
 - running
 - M-files 5-27
 - run-time errors 7-17
- S**
- sampled data

- with ODE solvers 15-54
- save 5-6, 16-12, 17-74
 - function handles 21-25
- saveobj example 22-62
- saving
 - M-files 7-15
 - objects 22-60
- scalar
 - and relational operators 18-11
 - as a matrix 11-6
 - expansion 17-27
 - string 18-11
- scalar product 11-8
- scattered data
 - multidimensional interpolation 12-35
 - multidimensional tessellation 12-27
 - triangulation and interpolation 12-19
- Schur decomposition 11-37
- Scientific Data API
 - programming model 6-33
- scripts 17-3, 17-7
 - characteristics 17-3
 - example 17-7
 - executing 17-7
- scrolling in Command Window 3-10
- SCS. *See* source control system
- seamount data set 12-20
- search path 5-14, 17-12
 - M-files on 17-43
- searching
 - Help browser 4-13
 - results 4-14
 - text in page 4-19
 - tips 4-14
 - type 4-13
 - M-file content 5-28, 7-12
 - technical support Online Knowledge Base 4-13
- second difference operator, example 16-9
- section breaks
 - in calc zones 10-27
- selecting multiple items 2-19
- semicolon (;)
 - after functions 3-9
 - between functions 3-4
- separator in functions 3-5
- sequence of functions 8-11
- session
 - automatic log file 1-6
- session log
 - Command History 3-17
 - diary 3-12
- set method 22-13
- setfield 20-9
- setting breakpoints 7-22
- shadowed functions 5-15
- shell escape 3-12
- shell escape functions 17-70
- shiftdim 19-2
- shockbvp demo 15-68
- short 6-55
- short integer 6-55
- shortcut
 - MATLAB 1-3
- shortcuts 7-40
- shortcuts, keyboard 2-18
- Show Cell Markers command 10-31
- shut down
 - MATLAB 1-15
 - options 1-15
- simple inheritance 22-35
- Simulink
 - interfacing files with source control systems 9-2
- sin 17-7, 19-14

- single data type 17-23
- single precision 6-55
- single process 3-3
- single-precision matrix 17-22
- singular value matrix decomposition 11-39
- size
 - structure arrays 20-10
 - structure fields 20-10
- size 16-25, 19-8, 20-10
- sizing windows in the desktop 2-9
- smallest value system can represent 17-21
- smart recall 3-7
- solution changes, rapid (BVP example) 15-68, 15-72
- solution statistics (BVP) 15-81
- solving linear systems of equations
 - sparse 16-36
- sort 16-29
- source control system
 - current system 9-4
 - interfacing with 9-2
 - preferences 9-4
 - specifying 9-4
 - supported systems 9-2
- SourceSafe project hierarchy 9-6
- spaces in MATLAB commands 3-4
- spacing
 - output in Command Window 3-14
 - tabs in Command Window 3-14
- sparse 16-7, 16-25
- sparse data type 17-24
- sparse matrix 17-22
 - advantages 16-6
 - and complex values 16-7
 - Cholesky factorization 16-33
 - computational considerations 16-25
 - contents 16-13
 - conversion from full 16-3, 16-7
 - creating 16-7
 - directly 16-8
 - from diagonal elements 16-10
 - defined 16-2
 - density 16-7
 - distance between nodes 16-22
 - eigenvalues 16-39
 - elementary 16-3
 - example 16-9
 - fill-in 16-22
 - importing 16-12
 - linear algebra 16-4
 - linear equations 16-5
 - linear systems of equations 16-36
 - LU factorization 16-30
 - and reordering 16-31
 - mathematical operations 16-25
 - nonzero elements 16-13
 - maximum number 16-9
 - specifying when creating matrix 16-8
 - storage 16-6, 16-13
 - values 16-13
- nonzero elements of sparse matrix
 - number of 16-13
- operations 16-25
- permutation 16-26
- preconditioner 16-35
- propagation through computations 16-25
- QR factorization 16-33
- reordering 16-4, 16-26
- storage 16-6
 - for various permutations 16-28
 - viewing 16-13
- theoretical graph 16-17
- triangular factorization 16-30
- viewing contents graphically 16-15

- viewing storage 16-13
- visualizing 16-21
- working with 16-3
- sparse ODE examples
 - Brusselator system (brussode) 15-38
- spconvert 16-12
- spdiags 16-10
- special values 17-21
- speye 16-25, 16-28, 16-32
- splash screen
 - UNIX startup option 1-9
 - Windows startup option 1-6
- spones 16-28
- spparms 16-37
- sprand 16-25
- spreadsheet data
 - importing 6-23
- sprintf 6-62
- spy 16-15
- spy plot 16-21
- square brackets
 - for output arguments 17-9
- squeeze 19-2, 19-11, 19-15
- sscanf 6-60
- stack
 - viewing 5-8
- starting MATLAB
 - DOS 1-3
 - UNIX 1-3
 - Windows 1-3
- startup
 - directory for MATLAB 1-3
 - changing 1-4
 - files for MATLAB 1-5
 - M-files open 7-37
 - options for MATLAB 1-5
 - UNIX 1-7
 - Windows 1-5
- startup cost
 - minimizing for ODE solvers 15-52
- startup.m 1-5
- Stateflow files
 - source control 9-2
- statements
 - conditional 17-14
 - long (on multiple lines) 3-5
- statistical data
 - missing values 13-14
 - normalizing 13-23
 - outliers 13-15
 - preprocessing 13-14
 - removing NaNs 13-15
 - See also* multivariate data
 - See also* univariate data
- statistics
 - descriptive 13-8
- step size (ODE) 15-25
 - initial step size 15-26
 - upper bound 15-26
- stepping through M-file 7-25
- stiff ODE examples
 - Brusselator system (brussode) 15-38
 - differential-algebraic problem (hb1dae) 15-47
 - finite element discretization (fem1ode) 15-35
 - van der Pol (vdpole) 15-33
- stiffness (ODE), defined 15-14
- stopping a running program 3-11
- storage
 - array 17-51
 - for various permutations of sparse matrix 16-28
 - of sparse matrix 16-6
 - sparse and full, comparison 16-7
 - viewing for sparse matrix 16-13

- str2func
 - description 21-22
 - example 21-23
 - strcmp 18-10
 - strings
 - across multiple lines 3-5
 - color indicators 2-24
 - See also* character arrays
 - struct data type 17-24
 - structs 20-5, 20-6, 20-17
 - structure arrays 20-4
 - accessing data 20-7, 20-9
 - adding fields 20-10
 - applying functions to 20-10
 - building 20-5
 - using structs 20-6
 - data organization 20-12
 - deleting fields 20-10
 - element-by-element organization 20-15
 - expanding 20-5, 20-6
 - fields 20-4
 - assigning data to 20-5
 - assigning using `setfield` 20-9
 - indexing
 - nested structures 20-18
 - within fields 20-8
 - multidimensional 19-19
 - applying functions 19-20
 - nesting 20-17
 - obtaining field names 20-6
 - organizing data 20-12
 - example 20-16
 - overview 20-4
 - plane organization 20-14
 - preallocation 17-74
 - size 20-10
 - subarrays, accessing 20-8
 - subscripting 20-5
 - used with classes 22-8
 - within cell arrays 20-31
 - writing M-files for 20-11
 - example 20-12
- structures
 - See also* structure arrays
 - styles in M-book
 - Normal 10-18
 - subassign 22-17
 - subfunction, going to in M-file 7-11
 - subfunctions 17-43
 - accessing 17-43
 - creating 17-43
 - debugging 17-44
 - definition line 17-43
 - function handles to 21-4, 21-19
 - in dispatching priority 17-12
 - precedence of 22-69
 - subsasgn 22-14
 - subscripted assignment 22-17
 - subscripting 17-46
 - how MATLAB calculates indices 17-53
 - multidimensional arrays 19-3
 - overloading 22-14
 - page 19-3
 - structure arrays 20-5
 - with logical expression 17-32
 - with the `find` function 17-32
 - subsref 22-14
 - subsref method 22-14
 - substring within a string 18-13
 - subtraction operator 17-26
 - suggestions to The MathWorks 4-32
 - sum 16-26, 16-29, 19-14
 - sunspot periodicity
 - calculating using Fourier transforms 13-45

- superiorto function 22-66
 - superseding existing M-files names 17-44
 - suppressing output 3-9
 - switch 17-37
 - case groupings 17-37
 - example 17-38
 - multiple conditions 17-38
 - symamd 16-29
 - symmetric
 - matrix 11-8
 - symmmd 16-29, 16-31
 - symrcm 16-29, 16-31
 - syntax
 - color indicators 2-24
 - errors 7-17
 - highlighting 7-8
 - syntax coloring and indenting 3-5
 - system requirements 1-3
 - systems of equations. *See* linear systems of equations
- T**
- tab
 - completion of line 3-8
 - spacing in Command Window 3-14
 - tabbing desktop windows together 2-14
 - table of contents for help 4-9
 - tabs 7-9, 7-40
 - tabs in string arrays 18-12
 - Technical Support
 - contacting 4-32
 - searching Online Knowledge Base 4-13
 - technical support Web page 2-20
 - tempdir 6-53
 - templates
 - M-book 10-18
 - specifying 10-25
 - tempname 6-53
 - temporary files
 - creating 6-53
 - terminating a running program 3-11
 - tessellations, multidimensional
 - Delaunay 12-30
 - Voronoi diagrams 12-32
 - text
 - converting to input cells 10-27
 - finding in page in Help browser 4-19
 - preferences in MATLAB 2-23
 - styles in M-book 10-18
 - text editor, setting as default 7-36
 - text files
 - importing 6-4
 - reading 6-58
 - theoretical graph 16-17
 - example 16-18
 - node 16-17
 - three-dimensional interpolation 12-17
 - time
 - measured for M-files 8-2
 - numbers 17-63
 - time-out message
 - while evaluating multiple input cells in an M-book 10-29
 - Toggle Graph Output for Cell command 10-31
 - token in string 18-13
 - tolerance 17-21
 - toolbar, desktop 2-17
 - toolbox path cache 1-10
 - enabling 1-12
 - generating 1-12
 - preferences 1-10
 - updating 1-13
 - tools in desktop

- description 2-2
- running from Launch Pad 2-5
- See also* windows in desktop
- tooltips 2-17
- preference in MATLAB 2-23
- transfer functions
 - using partial fraction expansion 12-8
- transpose
 - complex conjugate 11-8
 - unconjugated complex 11-8
- transpose 19-13
- triangular factorization
 - for sparse matrices 16-30
- triangular matrix 11-25
- triangulation
 - closest point searches 12-25
 - Delaunay 12-21
 - scattered data 12-19
 - Voronoi diagrams 12-26
 - See also* tessellation
- tricubic interpolation 12-17
- trigonometric functions 17-7, 19-14
- trilinear interpolation 12-17
- troubleshooting (ODE) 15-50
- twobvp demo 15-58
- two-dimensional interpolation 12-13
 - comparing methods graphically 12-14
- type ahead feature 3-7

U

- uchar data type 6-55
- uint data type 17-24
- unary minus operator 17-26
- Undefine Cells command 10-32
- underdetermined
 - rectangular matrices 11-18

- undo in MATLAB 2-17
- undoccheckout 9-11
- undocking windows from desktop 2-12
- Ungroup Cells command 10-32
- unitary matrices
 - QR factorization 11-28
- univariate data 13-4
- unknown parameters (BVP) 15-67
 - example 15-63
- unregserver startup option 1-6
- updates to products 2-20
- updating optimization code to MATLAB Version 5
 - syntax 14-16
- uppercase usage in MATLAB 3-4
- Use 16-Color Figures check box 10-23
- user classes, designing 22-9
- user input
 - obtaining interactively 17-69
- UserObject data type 17-24
- utilities, running from MATLAB 3-12

V

- value
 - largest system can represent 17-21
- values
 - data type 6-54
 - examining 7-26
- van der Pol example 15-33
 - simple, nonstiff 15-11
 - simple, stiff 15-14
- varargin 17-17, 20-27
 - in argument list 17-18
 - unpacking contents 17-17
- varargout 17-17
 - in argument list 17-18
 - packing contents 17-17

- variable-order solver (ODE) 15-30
 - variables
 - clearing 5-8
 - deleting
 - and memory use 17-75
 - dispatching priority 17-12
 - displaying values of 5-11
 - editing values for 5-10
 - global 17-19
 - rules for use 17-20
 - graphing from the Workspace browser 5-9
 - local 17-19
 - memory usage 17-76
 - naming 5-14, 17-19
 - persistent 17-20
 - replacing list with a cell array 20-25
 - saving 5-5
 - storage in memory 17-75
 - viewing during execution 7-17
 - workspace 5-3
 - vdpode demo 15-33
 - vector
 - of dates 17-65
 - preallocation 17-73
 - vector products
 - dot or scalar 11-8
 - outer and inner 11-7
 - vectorization 17-71
 - example 17-71
 - replacing for
 - vectorization 17-35
 - vectorizing ODE function (BVP) 15-79
 - vectors
 - column and row 11-6
 - multiplication 11-7
 - vehicle traffic sample data 13-4
 - version 17-21
 - version control system. *See* source control system
 - version information 4-32
 - version startup option for UNIX 1-7
 - version, obtaining 17-21
 - viewing desktop tools 2-7
 - Visible figure property
 - embedding graphics in M-book 10-21
 - visualizing
 - cell array 20-21
 - sparse matrix
 - spy plot 16-21
 - visualizing solver results
 - BVP 15-66
 - ODE 15-12
 - PDE 15-91
 - Voronoi diagrams
 - multidimensional 12-32
 - two-dimensional 12-26
- W**
- warnings 17-59
 - displaying 17-60
 - Web
 - accessing from MATLAB 2-20
 - Web browser in MATLAB 4-4
 - Web site for The MathWorks 2-20
 - what 5-22
 - which used with methods 22-70
 - while 17-39
 - empty arrays 17-39
 - example 17-39
 - syntax 17-39
 - white space
 - finding in string 18-12
 - who 5-5
 - whos 5-5, 16-7, 19-8

- interpreting memory use 17-75
- Windows
 - MATLAB use of system resources 17-77
- windows in desktop
 - about 2-2
 - arrangement 2-7
 - closing 2-9
 - docking 2-10
 - moving 2-10
 - opening 2-7
 - sizing 2-9
 - undocking 2-12
- winword.exe 10-24
- Word documents
 - converting to M-book 10-5
- work directory 1-3
- working directory 5-20
- workspace
 - base 5-8
 - clearing 5-8
 - context 17-14
 - defined 5-3
 - functions 5-8
 - initializing in an M-book 10-10
 - loading 5-7
 - M-book contamination 10-6
 - of individual functions 17-14
 - opening 5-7
 - protecting integrity 10-6
 - saving 5-5
 - tool 5-3
 - viewing 5-4
 - viewing during execution 7-17
- Workspace browser
 - description 5-3
 - preferences 5-9
- wrap lines 3-15

- writing
 - ASCII data 6-16
 - HDF data 6-44
 - in HDF format 6-41
- writing data to disk file
 - overview 6-2

X

- xor 17-31
- Xserver option for UNIX 1-7

Z

- zeros
 - of mathematical functions 14-12
- zeros 16-25, 19-6

